



CONCRETE SIKA RCC DAMS HANDBOOK

Sika RCC Dams Handbook

FOREWORD

Concrete is the most common building material in the world, and at a basic level it is a composite material that consists of aggregates, cement and water, which are mixed together in defined proportions. This wet mixture can then be poured, placed and compacted into position where, depending on a combination of factors, it hardens over a given time. Concrete is very versatile due to its inherent strengths and other properties, including high resistance to wind and water, plus the ability to withstand high temperatures. These qualities make concrete a particularly suitable building material for large structures such as dams.

Dams are usually huge structures that require massive amounts of concrete to build them, which of course leads to a high cost. For this reason, alternative cost effective solutions must be considered to minimize the cost of these dams construction. One well-proven option is the possibility of using Roller-Compacted Concrete (RCC), which, by definition, means the use of concrete with a no-slump consistence in its unhardened state, and that derives its name from method of placement and compaction for the construction of structures such as dams. The RCC ingredients are basically the same as for conventional concretes, but the concrete mix designs have very different ratios of these ingredients.

Compared to conventional concrete dams, which are usually built in large blocks, a RCC dam is usually built in relatively thin, horizontal lifts, which allows a rapid construction. Building dams with RCC has therefore become very popular around the world because of its advantages, with several new adaptations of the method that have been developed over the past two decades from experience gained on all these different projects.

This RCC Dams Handbook is now intended to be a "Chapter by Chapter" guide to the main methods and laboratory testing for the successful production of Roller-Compacted Concrete, and as such to be a basic tool for RCC technology and methodology to meet different project requirements.

The authors of the RCC Dams Handbook would like to thank Charles Alberto and Philippe Doriot for their contribution and support.

Editors
Sika Services AG
Tüffenwies 16
CH-8048 Zürich

Authors
Ing. Fabrizio Avallone, Sika Services AG
Dipl.-Ing FH Markus Jahn, Sika Services AG
Dr. Oscar Marazzini, Sika Services AG

Layout
Sika Services AG
Corporate Marketing Service

© 2019 by Sika AG
All rights reserved

Edition 2019

August 2019

CONTENT

Foreword	3
Content	4
1 General Information	7
1.1 Introduction	7
1.2 History of RCC Development	9
1.3 Advantages and Disadvantages of RCC in Dams	11
1.4 Design Considerations	12
1.5 Trends and Developments in RCC for Dams	13
2 RCC Materials	14
2.1 Cementitious Materials	14
2.1.1 Cement	15
2.1.2 Pozzolans (e.g. fly-ash) and Slag Cement (GGBFS)	15
2.2 Aggregates	16
2.2.1 Aggregate Gradings	18
2.2.2 Aggregate Quality	19
2.3 Water	20
2.4 Chemical Admixtures	21
3 RCC Mix Design Requirements	28
3.1 Basic Considerations	28
3.2 Mix Proportioning Procedures	30
3.2.1 Concrete approach	31
3.2.2 "Soils" Approach	36
3.3 Refinement of Mix Proportions	38
3.3.1 Laboratory Trial Mixes	38
3.3.2 Site Laboratory Trial Mixes	38
3.3.3 Full-scale Trials	38
3.4 Typical Mix Proportions	39
4 Laboratory Tests	40
4.1 General	40
4.2 Fresh RCC Properties and Tests	42
4.2.1 Vebe Consistency	42

4.2.2 Density	45
4.2.3 Moisture/Water Content	47
4.2.4 Air Content	48
4.2.5 Setting Time	49
4.2.6 Cement Content	50
4.2.7 Segregation Potential	50
4.2.8 Temperature	50
4.3 Hardened RCC Properties and Tests	51
4.3.1 Requirements for Specimens and Moulds	51
4.3.2 Compressive Strength	54
4.3.3 Tensile Strength	57
4.3.4 Young's Modulus of Elasticity (E-Modulus)	60
4.3.5 Creep	61
4.3.6 Durability	62
4.3.7 Permeability	62
4.3.8 Volume Change	62
4.3.9 Thermal Properties	63
5 Construction	64
5.1 General Considerations	64
5.2 Aggregates Production	65
5.3 Batching and Mixing	65
5.4 Transporting and Delivery	67
5.4.1 Conveyors	67
5.4.2 Vehicle Transportation Systems	68
5.4.3 Combination Transport Systems	69
5.5 Placing and Spreading	70
5.6 Compaction	71
5.7 Joints between Layers of RCC	72
5.7.1 Classes of Joint AND Necessary Treatments	73
5.7.2 Bedding Mixes on Hardened RCC	74
5.8 Contraction Joints and Crack Control	77
5.9 Facing Systems for RCC	77
5.10 Galleries and Waterstops	79
6 Quality Control	80
6.1 General	80
6.2 Activities prior to RCC Placement	81
6.3 Activities during RCC Placement	83
6.4 Activities after RCC Placement	84
6.5 Training	85
6.6 Troubleshooting during RCC Dam Construction	86

7	Sika Reference Projects	88
7.1	RCC Dams around the World	88
7.2	Sika's Global RCC Dams Reference List	89
7.3	RCC Dam and Sika Products	91
8	Bibliography	92
9	Index	94

1 GENERAL INFORMATION

1.1 INTRODUCTION

Roller-Compacted Concrete (RCC) can be considered as both a construction material and a construction method. It has probably been the most important development in concrete dam technology in the past 40 years, but it is used also for other many applications, such as:

- Heavy-duty mass concrete applications such as in:
 - ports
 - military installations
- Roadway and paving applications:
 - highway shoulders
 - highways and roadworks
 - airfield, aprons and other pavements



Figure 1.1.1: RCC spreading and compacting with dozers

The term “Roller-Compacted Concrete (RCC)” describes the concrete used in the construction of dams, combining the cost-effective and rapid placing techniques that are used for earth-fill dams, with the strength and durability of concrete, and gets its name from the heavy rollers that are used to compact it into its final form. RCC is usually mixed using high-capacity continuous batching equipment, is delivered with trucks or conveyors and spread with bulldozers in layers, also called lifts as with other concreting techniques, prior to compaction. Placement of RCC is in horizontal layers, which is also similar to earth- and rock-fill dam construction techniques. In this way, RCC dam structures can be raised at a rate of close to 10 meters per month, or even more.

RCC has similar strengths and other properties and consists of the same basic ingredients as conventional concrete, but in different mix proportions. It is by definition, concrete with a no-slump consistency in its fresh stage, which is transported, placed and then compacted using earth/rock fill-dam construction equipment. The definition of a no-slump concrete is a freshly mixed concrete with a slump less than 6 mm, where the slump is the difference between the height of the Abrams’ cone and the highest point of the fresh concrete specimen.

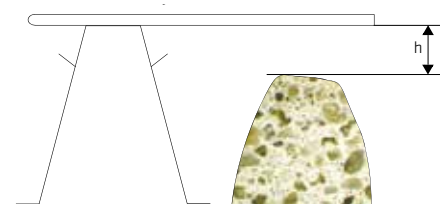

Figure 1.1.2: Measurement of slump



Figure 1.1.3: Forms of slump

The use of RCC has allowed many new dams to become economically viable due to reduced costs obtained from the significant reduction in construction times. RCC also provides design engineers with the opportunity to economically refurbish and upgrade existing concrete dams, that have potential problems with stability and need additional buttressing, plus embankment dams with inadequate spillway capacity can be safely overtopped.

This handbook is intended as a guide to developments in RCC technology, including materials, mix proportioning, construction methods, quality control and laboratory testing.

1.2 HISTORY OF RCC DEVELOPMENT

The history of RCC in dam technology can be traced from the earlier use of Roller-Compacted Concrete in road construction and then as an infill material for its first use in dams, followed by subsequent development of the technology. RCC has generally been in widespread regular use since the late 1920s, particularly as the base for highways and airfield pavements. In these and other civil engineering applications, it is commonly also known as lean-mix or dry-lean concrete.

Improved soil mechanics technology and an increasing popularity of embankment dams following World War II coincided with a steady decline in the construction of concrete gravity dams. Earth and rockfill embankments could be built more cost effectively than dams, primarily due to the greater efficiency of earth-moving equipment and embankment construction methods. Then the dam-building community began searching for a new type of dam that combined the efficiencies of embankment dam construction with the reduced cross-section and performance of concrete dams.

An early form of RCC, termed “rollcrete”, was used to provide central impervious core for an earthfill embankment cofferdam for Shihmen Dam, in Taiwan, in 1960-1961. A concrete gravity dam was first built using lean-mix concrete that was placed in horizontal 700 mm thick layers, using earth-moving equipment, at Alpe Gera Dam, in Italy, between 1961 and 1964, although consolidation was by internal immersion vibration rather than by roller compaction. The major break-through that led to the construction of this dam and therefore paved the way from RCC dams, was the series of full-scale trials that showed the excellent performance of RCC. Vibratory rollers were first used to compact soil-in lifts for the Berney M. Davis Reservoir dam in Texas, back in 1971. Then the first use of RCC as we know it and in large volumes was for the Tarbela Dam in Pakistan, in 1975.

RCC dams design began evolving in three different directions during the 1970s. The U.S. Army Corps of Engineers (USACE), and others in the United States, were developing a lean-concrete alternative with a high fines content that culminated in construction of Willow Creek Dam in Oregon, in 1982. Meanwhile, British engineers were developing a high-paste alternative that combined conventional concrete mix design with earthfill dam construction methods. Extensive laboratory research and field testing in England resulted in the development of a low-cement, high-pozzolan content concrete (252 kg/m³ of cementitious material although 69% of this was low-lime fly ash), which became the basis for the US Bureau of Reclamation’s design of Upper Stillwater Dam, in Utah, which was built between 1985 and 1987. This RCC proved to be impermeable and subsequent testing also showed that it had excellent properties, including at the joints between the layers.

Elk Creek dam (USA), built in 1987-1988, continued the development of the RCC method of construction, whereby the RCC was designed to be more workable and efforts were made to eliminate segregation of the concrete. A bedding mix between layers was also developed and used to further reduce the possibility of permeable lift joints.

Japanese engineers developed an approach defined as the “Roller-Compacted Dam method (RCD)” designed to achieve the same quality and appearance of conventional mass concrete, which resulted in the placement of RCC for the main body of Shimajigawa Dam in Japan, from 1978 to 1980. This RCC method resulted from the rationalization of three factors in concrete dam construction.

- **Construction.** The use of larger construction equipment, such as is used for embankment dams, and a horizontal concreting area, to decrease formwork requirements for construction joints and to reduce the time of construction.
- **Materials.** Decreasing the cement content and using fly ash for improved workability, to reduce thermic cracking due to heat generation.
- **Design.** This concept allowed the design of an economic dam, even on poor foundations where previously only embankment dams would have been possible.

Other early, notable developments in RCC construction include the first use of precast concrete panels with an attached PVC membrane to provide an impervious upstream face at Winchester Dam, in Kentucky, in 1984, as well as the erosion resistance of exposed RCC that was demonstrated by sustained overtopping of the Kerrville Ponding Dam in Texas, in 1985.

The use of RCC to rehabilitate existing concrete and embankment dams started in the U.S. in the mid-1980s and has continued to flourish through recent years. The primary use of RCC to upgrade concrete dams has been to reinforce existing structures and improve their seismic stability. For embankment dams, RCC has mainly been used as an overlay on the downstream slope to allow safe overtopping during infrequent flood events.



Figure 1.2.1: RCC dam construction

1.3 ADVANTAGES AND DISADVANTAGES OF RCC IN DAMS

The advantages of the RCC method of dam construction are numerous, but there are also some disadvantages, which although only applicable to some specific site conditions and designs, must be recognized and considered where appropriate.

Each RCC project must therefore be thoroughly evaluated, basing decisions on both technical and commercial/cost points of view, and in comparison with the possible alternative methods of construction. In this way, RCC construction techniques have made RCC gravity dams an economically competitive alternative to conventional concrete and embankment dams due primarily to the following factors.

- **Rapid construction:** The RCC construction process encourages the near continuous placement of concrete, making very high production rates possible, which can very significantly shorten the construction period for a dam. When compared with large embankment structures or conventional concrete dams, the use of RCC can shorten the construction time by several months, or even years;
- **Costs:** Construction-cost histories of RCC show that the cost is considerably less than conventionally placed concrete dams (ranging from 20 to 50 percent less). The difference in percentage savings usually depends on the costs of the aggregate and cementitious materials, the complexity of the placement and the total quantities of concrete placed. Savings associated with RCC are primarily due to reduced forming, placement and compaction costs, plus the reduced overall construction times.
- **Performance:** A key factor for RCC concrete strength development is the compactability of the material. Therefore there is also an optimum moisture content that allows higher density and with this higher strength values to be achieved in comparison with conventional concrete.

When compared with embankment dams, the smaller volume of RCC gravity dams makes the construction materials source less of a driving factor in the site selection, and RCC dams also offer the cost-effective alternative of constructing the spillway in the main structure of the dam (embankment dams normally require the spillways be constructed in an abutment). The RCC gravity dam is therefore more resistant to internal erosion and capable of passing floods during the construction time without such significant damage. Although well-designed RCC dams are frequently the lowest-cost solution, there are conditions that can make RCC dams more expensive. The situations where RCC may not be appropriate include those where aggregates is not reasonably available locally, the bedrock for foundations is of poor quality or is too deep from the surface, or where the river valley is very narrow, leaving limited room to maneuver heavy equipment.

1.4 DESIGN CONSIDERATIONS

During development of a Roller-Compacted Concrete method of construction, three different mix designs/concepts have to be considered. Although these classifications are essentially based on the cementitious content, each method has a slight different philosophy towards the design of the dams.

- Low-cementitious content RCC dam, with a low cementitious (i.e. Portland cement and additives) content ($< 100 \text{ kg/m}^3$)
- RCD (Rolled Concrete Dam) method: this method was developed in Japan, and is rather different from those used elsewhere in the world (cementitious $120\text{-}130 \text{ kg/m}^3$)
- High-cementitious RCC: obviously using a high cementitious content ($> 150 \text{ kg/m}^3$)

A further classification of a medium-cementitious RCC dam, which has a cementitious content between 100 and 149 kg/m^3 , can also be added to cover the whole range of cementitious contents. Table 1.4.1 shows some characteristics of these four mix designs / concepts.

Table 1.4.1: Classification of RCC dams

Classifications	Low Cementitious	RCD	Medium Cementitious	High Cementitious
Cementitious content (kg/m^3)	≤ 99	120 - 130	100 - 149	≥ 150
Additives content (%)	0 - 40	20 - 35	20 - 60	30 - 80
Layer thickness (mm)	± 300	750 - 1000	± 300	± 300
Joint spacing (m)	30 - ∞	15	15 - 50	20 - 75

Cementitious content = Portland Cement and Additives

1.5 TRENDS AND DEVELOPMENTS IN RCC FOR DAMS

RCC dams built up to the end of 1986 might be considered as the first generation of RCC dams (low-cementitious content). Currently, there has been a swing from low-cementitious RCC dams towards medium- and high-cementitious content RCC dams. The reasons for this change in direction seem to be following:

- *Greater understanding of the RCC performance.* It has been shown, based on the investigations of specimens from completed dams, that excellent performance can be obtained with optimum cementitious content RCC dam.
- *The increase in size of RCC dams.* Due to their increasing size requirements, up to 100 meters or even greater in height, has come the need for improved concrete properties and performance in RCC dams. High-cementitious content RCC has been found to have higher in-situ performance compared to low-cementitious RCC, especially in terms of cohesion and direct tensile strengths.
- *The changing use of RCC dams.* Hydroelectric projects are more and more adopting RCC dam construction method and here the water is retained continuously and thus watertightness has also become an important criteria in the specification.
- *Economy.* With the improved performance properties of high-cementitious content RCC, compared to low-cementitious RCC, the cross-section of a gravity dam can be reduced, particularly in areas where there is seismic activity. In spite of the higher material costs, it has been shown that the overall cost of a high-cementitious content RCC dam can thereby be cheaper than an equivalent low-cementitious RCC dam.

Finally, it can be said that the use of Roller-Compacted Concrete in dam construction is a very cost-effective method and, given a suitable site, it is almost always the cheapest method of constructing a dam when all relevant factors are taken into account. The selection of the appropriate mix design is based on the site and design requirements.

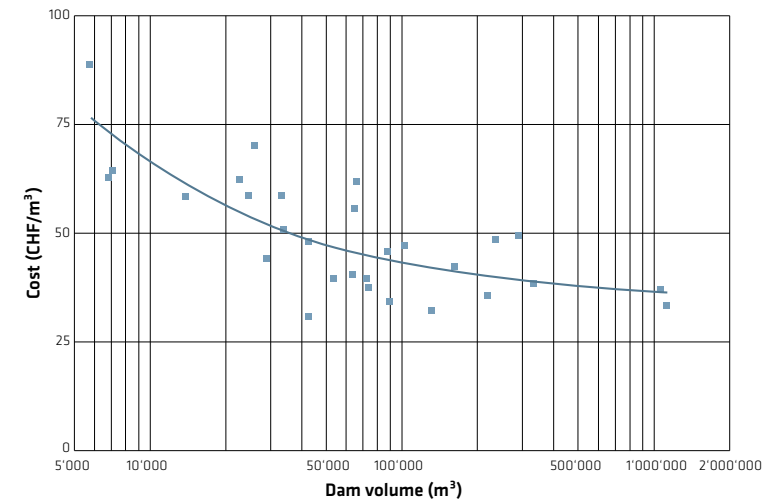

Figure 1.5.1: RCC costs (2000's price level)

2 RCC MATERIALS

Concrete has three basic constituent materials, cement, aggregate and water. To extend the installation and performance properties and therefore its potential applications, it can easily become a system of five components, resulting in more complex interactions, especially when combined with wider application parameters for the RCC.

It is always necessary to assess the availability and suitability of the materials needed to manufacture RCC, with the qualities necessary to meet the structural and durability requirements. A preliminary investigation should particularly emphasize the need to meet any high RCC production and placement rates. Additional investigations may then be needed for RCC in various other specialised applications, as appropriate.

2.1 CEMENTITIOUS MATERIALS

Cementitious materials include Portland cement and pozzolans, which should comply with American Society for Testing Materials (ASTM) or the equivalent quality requirements that apply locally. The selection of the cementitious materials significantly affects the rate of hydration and strength development.

RCC can be made with any of the basic types of cement, though usually it is with a combination of cement and additives. The use of pozzolans is common as these can generally provide reduced costs and lower heat generation.



Fig 2.1.1: Typical RCC dam batching plant

2.1.1 CEMENT

Cement is one of the key components in RCC production and the most commonly used type is OPC – Ordinary Portland Cement. When selecting the type of cement for both RCC and conventional concrete, factors to be taken into account include the quality and the specific type of the cement, how it reacts with the intended pozzolans, plus the manufacturer’s capability to produce deliver sufficient consistent qualities and quantities, as well as the delivery cost to site.

Cement should meet the requirements of ASTM C 150, but for mass RCC applications, cements with a lower heat generation than Type I can be beneficial. These include ASTM C 150, Type II (moderate heat of hydration) and Type V (sulphate-resistant) and ASTM C595, Type IP (Portland-pozzolan cement) and Type IS (Portland-blast furnace slag cement).

The cement content can vary from 63 – 154 kg/m³, depending on the mix design / construction concept, and the specific project requirements.

2.1.2 POZZOLANS (E.G. FLY-ASH) AND SLAG CEMENT (GGBFS)

The use of pozzolans or ground slag cement may be especially beneficial in RCC as a mineral filler and for its cementitious properties, as well as providing a degree of lubrication during compaction. The fine pozzolan/ground slag material occupies some of the paste volume otherwise occupied by cement and water.

Class F fly ash (low-calcium fly ash) is most commonly used as a pozzolan or mineral filler for RCC, but Class C fly ash (high-calcium fly ash) and Class N fly ash (calcined natural pozzolans) have also been successfully used. Fly ash is cheap and it is also suitable to help meet specific durability requirements. It is often used for hydration heat reduction as well as cost reduction.

When using pozzolans, they may replace up to 70% of the cement content, it depends on what type of RCC dam mix and design concept has been adopted. The cement in RCC mixtures can therefore be partially replaced with pozzolans for the following reasons:

- To reduce heat generation
- To reduce costs
- To increase workability
- To increase placement time
- To reduce CO₂ emissions

There are also different ways to add the fly ash, either during the production of cement itself, or it can be added directly to the concrete mix when it is batched. Laboratory testing should be done to verify and evaluate the benefits of using pozzolan.

2.2 AGGREGATES

Aggregates, consisting of sand and gravel or crushed stone, represent the granular skeleton of concrete that has to be infilled with the cementitious paste matrix. The aggregates can be obtained from the actual excavations for the dam itself, or they are provided from separate gravel or rock quarries, normally locally to minimise transportation costs. The grading and quality of aggregates can significantly affect the properties of both the fresh and hardened RCC as well as all other forms of concrete.

The aggregate grading influences the workability of the mixture, the total void ratio and the ability to effectively compact or consolidate the RCC. One of the most important factors in determining the quality and economy of concrete is therefore the selection of a suitable source of aggregates.

Testing of the aggregates physical properties should be completed before the RCC mix design is developed. Aggregates used for RCC can range from fully processed materials, meeting standards of specific grading and quality requirements, to minimally processed, unwashed 'pit-run' aggregates (quality standards as for conventional concrete but less stringent). Therefore the aggregate source should always be defined, tested and approved prior to construction works.



Figure 2.2.1: Aggregates stockpiles

Coarse aggregate should generally consist of graded natural gravel or crushed rock, or a mixture of natural gravel and crushed rock with a minimum of 50 percent crushed rock. Crushed fines should generally not be used in the production of RCC aggregates.

Fine aggregate should generally consist of durable natural sand, or natural sand supplemented with crushed sand, to make up for any deficiencies in the natural sand grading. Manufactured sand particles should be predominantly cubical and free from flat and elongated particles.

Table 2.2.1: Ideal coarse aggregate grading

Sieve Size	Cumulative Percent Passing		
	4.75 to 75 mm	4.75 to 50 mm	4.75 to 19 mm
75 mm (3 in.)	100	--	--
63 mm (2-1/2 in.)	88	--	--
50 mm (2 in.)	76	100	--
37.5 mm (1-1/2 in.)	61	81	--
25.0 mm (1 in.)	44	58	--
19.0 mm (3/4 in.)	33	44	100
12.5 mm (1/2 in.)	21	28	63
9.5 mm (3/8 in.)	14	18	41
4.75 mm (No. 4)	--	--	--

Table 2.2.2: Fine aggregate grading limits

Sieve Size	Cumulative Percent Passing
9.5 mm (3/8 in.)	100
4.75 mm (No. 4)	95 - 100
2.36 mm (No. 8)	75 - 95
1.18 mm (No. 16)	55 - 80
600 µm (No. 30)	35 - 60
300 µm (No. 50)	24 - 40
150 µm (No. 100)	12 - 28
75 µm (No. 200)	6 - 18
Fineness modulus	2.10 - 2.75

2.2.1 AGGREGATE GRADINGS

The nominal maximum size, also known as NMSA (Nominal Maximum Size of Aggregate), of coarse aggregate particles can vary from project to project, but usually, most RCC projects use a coarse aggregate with a NMSA between 37.5 and 75 mm. The use of aggregate sizes larger than 75 mm is expensive and creates problems with the control of segregation. The thickness of placement layer must always be more than three times the NMSA, generally around 300 mm.

As already mentioned, the grading of fine aggregates strongly influences the workability and compaction of all concretes including RCC. When low-cementitious RCC is used, a large percentage of material passing the 75- μ m (No. 200) sieve is required to increase the paste content of the mix to fill voids and contribute to sufficient workability, but the addition of excess fine aggregates may also be harmful to RCC, due to their increased water demand and possible strength loss. The Table and the Figure 2.2.3 show an example of a sieve analysis for RCC with 50 mm NMSA ("concrete" approach).

Table 2.2.1.1 Example of sieve analysis for RCC

Size of Aggregate: 0 - 50 mm (Sika Laboratory)		Sieve Analysis - Combined Grading							
Sieve Size		Group I 25.0 - 50.0	Group II 12.5 - 25.5	Group III 2.36 - 12.5	Group IV 0 - 2.36	Combined Grading	Project Specification		
inches						(cum. pass. %)	Min	Max	
#	or mm	18,2%	21,2%	25,0%	35,6%				
2" 1/2	63,50	100,0	100,0	100,0	100,0	100,0	100	100	
2"	50,00	100,0	100,0	100,0	100,0	100,0	98	100	
1" 1/2	37,50	80,0	100,0	100,0	100,0	96,4	92	100	
1"	25,00	5,0	100,0	100,0	100,0	82,7	76	88	
3/4"	20,00	0,0	73,0	100,0	100,0	76,1	66	79	
1/2"	13,00	0,0	5,7	100,0	100,0	61,8	55	67	
3/8"	9,50	0,0	1,4	73,9	100,0	54,4	47	59	
No.4	4,75	0,0	1,3	23,2	100,0	41,7	36	47	
No.8	2,36	0,0	1,3	2,9	97,7	35,8	28	38	
No.16	1,18	0,0	1,3	2,1	68,2	25,1	20	30	
No.30	0,60	0,0	1,3	2,0	48,1	17,9	15	23	
No.50	0,30	0,0	1,2	1,9	33,9	12,8	10	16	
No.100	0,15	0,0	1,1	1,7	22,7	8,7	7	12	
No.200	0,075	0,0	0,9	1,4	16,0	6,2	4	8	
No.325	0,045	0,0	0,7	1,2	13,6	5,3	1	3	
	Pan	0,0	0,0	0,0	0,0				

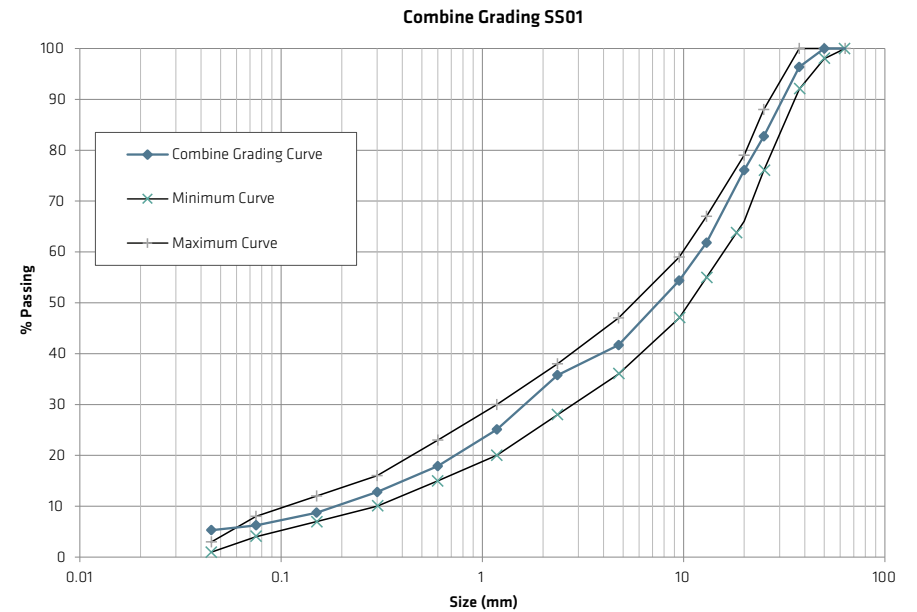

Figure 2.2.1.1: Example of combine grading curve for a RCC mix design

2.2.2 QUALITY

Aggregates similar to those used in conventional concrete have been used in RCC and the quality requirements for both fine and coarse aggregates are given in ASTM C 33. However, aggregates that do not meet these normal standards, or the requirements for conventional concretes, have also been successfully used in RCC dam construction. With RCC mix designs, such poor quality aggregates may break down and then compact well under the more severe mixing, transporting, placing and compacting conditions.



Figure 2.2.2.1: Aggregate samples

2.3 WATER

The combination of water with a cementitious material forms a cement paste by the process of hydration. As stated by Abrams' law, a lower water-cement ratio yields a stronger, more durable concrete, whereas more water gives a free-flowing concrete with a higher slump. Experience has shown that the source of water (groundwater vs. surface water) can also have a significant effect on RCC performance. Times of setting and strength development can vary significantly. The mix water must therefore not contain constituents that slow down or speed up the cement hydration process. These are mainly:

- Oil and grease
- Chlorides
- Sulphates
- Sugar
- Salt

Water occurring naturally such as groundwater, rainwater, river water and lake water is normally suitable, but sea water should not be used due to its high chloride content. Drinking quality (potable) water is always suitable for the production of Roller-Compacted Concrete. Additionally, any ice used in mix water to reduce the mix temperature of RCC should also be made from water meeting these requirements.



Figure 2.3.1: Source of fresh water next to a cement plant

2.4 CHEMICAL ADMIXTURES

Concrete admixtures are used to improve and/or change concrete properties, which cannot be correctly controlled by the cement, aggregate and water mixture alone. Concrete admixtures and additives make concrete a complex multi-component composite system and these can also have a significant impact on the fresh and/or hardened concrete properties. The dosage of admixtures and additives is usually based on the cement content and on the results of laboratory tests with the specific other materials (cement, aggregates and water) where the effect of varying dosages are evaluated.

The use of admixtures in RCC follows the same guidelines as in any other conventional concrete, but they can also provide additional advantages that are not seen in standard concretes. The most commonly used admixtures in RCC are plasticizers (Sika® Plastiment®), retarding-plasticizers (Sika® Plastiment® and Sikament®), or air entraining agents (SikaControl® AER). The typical dosage rate of these materials is 0.4 - 1.5 % by weight of the cementitious materials.



Figure 2.4.1: Sika® Plastiment® storage tanks

Air-entraining admixtures can be added to create small bubbles of air distributed uniformly through the RCC, in the same way as it does in conventional concrete. The benefit of this is that the concrete gains increased resistance to repeated cycles of freezing and thawing when saturated. However, it is not commonly used in RCC (especially in RCC with high fines contents) because it is hard to create the bubbles of the proper size and distribution due to the no-slump consistency.

Just as with conventional concretes, the main reasons for using admixtures in RCC are their ability to meet the cost performance requirements (e.g. mechanical resistance) for a lower overall price. A summary of the advantages from their use in RCC is given below:

To reduce the amount of cement and achieve the same mechanical strengths

The use of a plasticizing or retarding-plasticizer admixture, especially designed for use in RCC, allows a reduction in the amount of water in the mix, but obtains the same compacting capacity and a lower w/c ratio. As mentioned before, the mechanical resistance of RCC is governed by these factors of maximum density and the w/c ratio.

A plasticizer reduces the amount of water necessary to reach the maximum density, which also results in a lower w/c ratio. This immediately translates into an increase of mechanical strengths for mixes with the same amount of cement. In this way the amount of cement used can be reduced until reaching the pattern of strength results required from the mix. Reduction of the required cement content for a defined strength requirement, is an important advantage both economically and in the reduction of hydration heat achieved, which in turn has beneficial effects in decreasing the risk of cracking.

The use of a retarding-plasticizer especially designed for RCC can represent very significant savings of 10 to 30 kilograms of cement per cubic meter of concrete (Table 2.4.1).

Table 2.4.1: Effects of the admixture on compressive strength

	Reference	Design 1	Design 2
Cement (kg)	100	100	90
Water	143	143	133
Admixture (%)	No admixture	1%	1,26%
Compressive Strength 28 days (kg/cm ²)	53	57	63
Compressive Strength Increasing (%)	-	+ 7,5%	+ 18,8%

To reduce the maximum initial temperature and the heat generation rate

If the tensile strength of the concrete is not high enough to withstand the thermal stress of hydration it can create significant cracking. The ACI 207- Mass Concrete guideline states that the difference in temperature between the centre of the element and the surface must remain smaller than 20°C (68 °F) during curing. As previously mentioned, this is the main cracking cause in mass concrete works. The reduction of cement required for a target strength allows a reduction in the hydration heat. During initial setting (in the first hours), the maximum heat generation is produced, this heat accelerates the end of the concrete setting and also the start of the concrete hardening, all to happen earlier than needed. The maximum initial heat value in RCC with a retarding-plasticizing admixture especially designed for RCC, is not only lower, but also the rate or slope value to reach it is considerably less, when compared to RCC without the admixture (Figure 2.4.2).

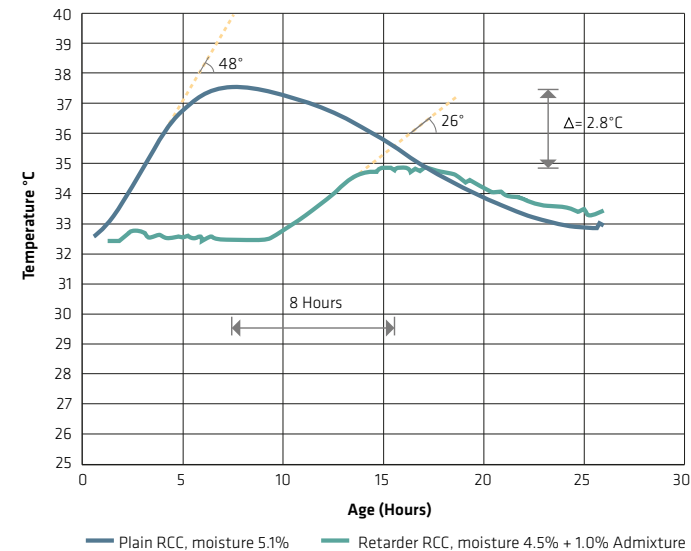

Figure 2.4.2: RCC's initial heat generation with add without plasticizing retarding admixture (1%)

The American Concrete Institute suggests that in winter times the compacted RCC layer must be exposed so this initial heat value can be spread. In summer, on the other hand, ACI suggests that the layer must be covered quickly with the next layer, so that the ambient / radiated temperature does not add any further heat to the initial temperature of the compacted layer. In warm zones or in summer, the sum of the maximum initial heat values is less in RCC with the admixture. This means that a retarded-plasticized RCC not only has a lower maximum initial heat value, but the temperature peak also takes place hours later, so when the layer reaches the maximum initial temperature, it is already covered and protected by the next layer.

As we can see the use of an admixture such as Sika® Plastiment® and Sikament®, can produce very important advantages for the thermal behavior of the structure, through this reduction in the amount of cementitious material required.

Increase in the amount of time available to obtain a hot joint

Since the bond between layers is a top priority in RCC, it is necessary to correctly establish the setting times of the material under different environmental conditions. Once the initial setting time has been identified for a mix, it is possible to define the limits for placing another layer without any additional treatment (a 'hot joint' rather than a 'cold joint' with fresh to hardened concrete). Frequently working within these defined limits becomes difficult and therefore the need to create and treat the interfaces as cold joints would also be frequent, resulting in a complex and slow construction process. However, the use of a retarding-plasticizer prolongs the concrete setting times, increasing the time during which it is possible to wait and apply the next layer without creating a cold joint. This in turn increases the production rate and saves both time and money. Figure 2.4.3 shows the tensile strength variation of RCC joints, measured in specimens made without the admixture (blue curve) and an RCC mix with the admixtures Sika® Plastiment® and Sikament® (red curve).

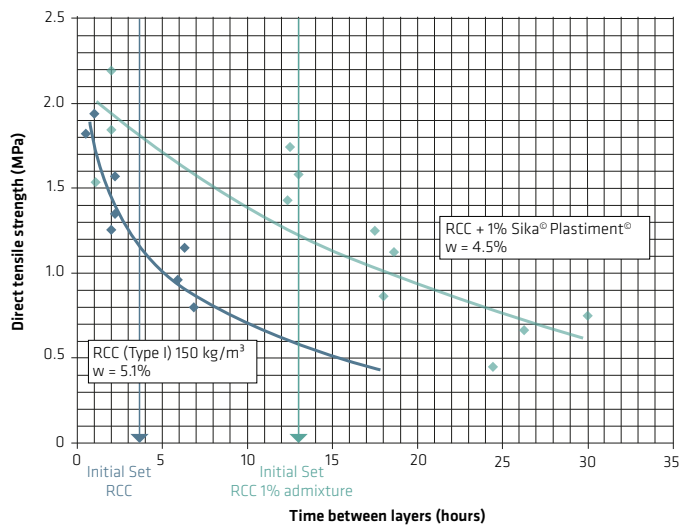

Figure 2.4.3: Direct tensile strength between layers and their initial relationship with setting times (28 days)

From this it can be seen that if a direct tensile strength of 13 kg/cm² has been specified as the maximum sett progression for a project, the mix with Sika® Plastiment® and Sikament® at 1% dosage allows 12 hours to place the next layer, whilst without it, there is only 3 hours to ensure adequate bond. Even before 12 hours it is interesting to see how the retarded material reaches higher adhesion levels compared to the fast loss of adhesion without the admixture.

Maximum compacting time increase

In conventional concretes, when they have gone through their initial setting and are exposed to vibration or revibration, their final mechanical properties would be affected. This is because once the initial set has been reached, the crystalline network, or the newly formed hydrates are still relatively weak and can quickly deteriorate if they are exposed to such mechanical stress. In RCC this phenomenon can also take place, and even to a greater extent due to the constant use of the vibrating rollers. It is therefore also necessary to correctly define the initial set times of the RCC mix and as a result, the time limits for compaction of the next layer of material, without interfering in its mechanical properties (Figure 2.4.4).

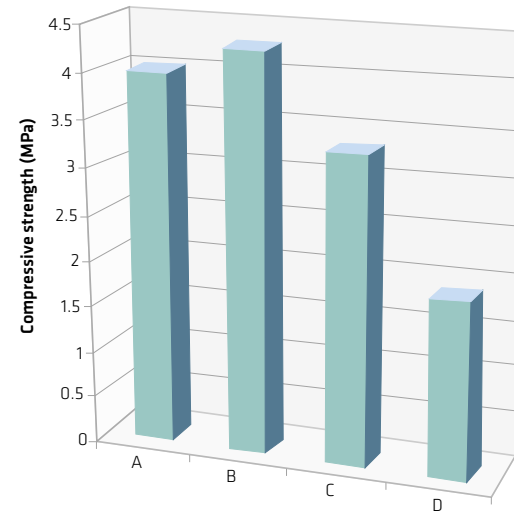

Figure 2.4.4: Over-compacting effect on the compressive strength at different setting stages.

- A) Compaction immediately after RCC's mixing
- B) Compaction before the initial set time
- C) RCC's compaction after the initial set time;
- D) RCC's compaction immediately after the final set time.

This over-compacting phenomenon that can destroy the crystals of cement hydration, can lead to a loss of compressive strength by up to 45%. If a retarding-plasticizer is used (e.g. Sika® Plastiment® and Sikament®), the allowable transit time on the layer increases, without the risk of damaging the previously placed material in its hardening stage.

Mechanical strengths increase without increasing the cement content

There are economic, design and construction circumstances that can make it necessary to increase the RCC's mechanical resistance without increasing the amount of cementitious material. The use of a retarding-plasticizing admixture increases significantly the mechanical strengths of RCC (Figure 2.4.5).

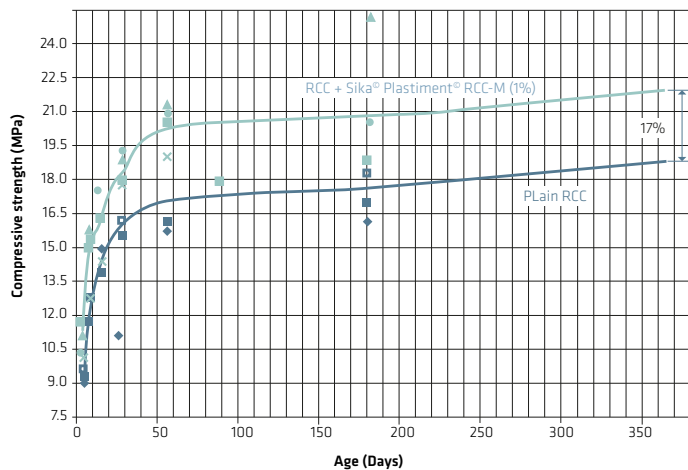

Figure 2.4.5: Compressive strength. RCC plain and RCC with Sika® Plastiment® RCC-M 1.0%.

Protection against extreme temperature conditions and freeze-thaw cycles

As with any conventional concretes, RCC is affected by the action of water in its capillary matrix when exposed to freeze-thaw cycles. The micro-cracking, that can be generated by the expansion of the liquid water when it freezes inside the pores, can create serious durability problems.

For dams constructed under these conditions, the use of an air entraining admixture allows more durable concrete structures and minimizes these harmful effects, with the micro-bubbles providing micro-voids in the matrix to accommodate the expansion.

Table 2.4.2: Summary of Sika RCC admixtures

Type	Product	Effect / Advantages
Water Reducing and Retarding	Sika® Plastiment®	<ul style="list-style-type: none"> Initial set times are delayed, allowing time for proper placement and finishing without cold joints in all weather conditions Increases concrete density and delivers increased early and ultimate, compressive and flexural strength Lower water cement ratios provide decreased permeability and increased durability Can be used to retard concrete during hot weather concreting
Super Plasticizer	Sikament®	<ul style="list-style-type: none"> Allows a better cement dispersion, resulting in a workable concrete of fluid consistency without loss of cohesion Depending on the dosage, the w/c ratio may be reduced by more than 12%, at the same time producing an increase of high early strengths by more than 50% in comparison with a conventional concrete
Air Entraining	SikaControl® AER	<ul style="list-style-type: none"> Improved workability Improved durability Increased cohesion reducing the risk of segregation Reduced water content without loss of workability Does not affect the setting time
Retarder	Sika® Retarder	<ul style="list-style-type: none"> Initial set times are delayed, allowing time for proper placement and finishing without cold joints in all weather conditions Can be used to retard concrete during hot weather concreting

3 RCC MIX DESIGN REQUIREMENTS

3.1 BASIC CONSIDERATIONS

Mixture proportioning methods for RCC are different from those of conventional concrete. RCC mix proportions depend largely upon the strength and durability requirements of the structure. However, RCC proportions may also be greatly influenced by project-specific requirements such as material availability, transport and conveying methods, spreading and compaction equipment.

Optimum RCC proportions consist of a balance between good material properties and acceptable placement methods. This includes minimizing segregation.

In implementing a specific mixture-proportioning procedure, the following considerations regarding RCC properties should be taken into account.



Figure 3.1.1: The RCC under compaction

- **Durability.** Durability of RCC depends on the quality of the materials, the exposure conditions and the expected compaction. RCC should be free of the damaging effects of alkali-aggregate reactivity. Freeze-thaw action and erosion, by aggressive water, are also commonly occurring and damaging processes that can adversely affect the durability of RCC dams. These can be avoided by protecting the upstream and downstream faces (exposed to water) with conventional concrete.
- **Strength.** The strength of compacted RCC, assuming the use of quality aggregates, is usually strongly determined by the water-cement ratio (w/c). Differences in strength and the degree of consolidation achieved with a given w/c can result from: changes in maximum aggregate size; grading, surface texture, shape and the strength of the aggregate themselves; differences in cement types and sources; entrapped and entrained air content; plus the use of admixtures that can affect cement hydration.
- **Workability.** It is this property that determines the RCC's capacity to be successfully placed and compacted without harmful segregation. It is affected by the same factors that affect the workability of conventional concrete (i.e., cement content, water content, the presence of chemical and mineral admixtures, and the grading, particle shape, and relative proportions of coarse and fine aggregates). The workability of RCC cannot be measured or judged with a slump test. As it is for conventional concrete, because RCC has a no-slump consistency. To check if the mixture is workable, the Vebe apparatus is typically used and this test produces a Vebe time that is used to measure the comparative mix consistency.
- **Generation of Heat.** Another major concern in the construction of a RCC dam is heat generation produced by the main dam's body. The hydration heat of cement governs the rise of the temperature and the goal is to minimize the heat developed during hydration, to avoid the risk of thermal cracking, but at the same time, to achieve sufficient strength growth by creating a suitable combination of pozzolan and cement. Tests on different percentages of the specific potential cement and pozzolan mixtures available are necessary to obtain the optimal combination.
- **Permeability.** Most of the concerns regarding RCC permeability are directed at lift-joint seepage. Higher cementitious content or high-workability mixtures will more easily produce adequate watertightness. However, lower cementitious or low-workability mixtures are not likely to produce adequate watertightness without special treatment, such as the use of bedding mortars/concretes between lifts.
- **Density.** Although the density depends mainly on the "Relative Density" of the aggregates used in the concrete, any entrapped air will lead to a loss of density and mechanical properties and, if this air content is significant, also to a greater volume of concrete having to be placed. The entrapped air in Roller-Compacted Concretes, that has been placed for dams so far, has tested to range from 0.5 to 5.0 % - the percentage has been as high as 8.5 % during some trials. A wide range of densities can therefore be obtained using different materials mixed in different proportions.

3.2 MIX PROPORTIONING PROCEDURES

There are several methods that have been used for the selection of the RCC mix proportions. Most of these can be grouped under two general headings: the “concrete” approach, and the “soils” (or geotechnical) approach.

RCC’s using “concrete” design methods generally have a more fluid consistency and are more workable than mix designs developed using the “soils” approach, although both will produce a no-slump concrete. In the “concrete approach”, RCC is considered a true concrete, composed of well-graded aggregates, in which the water/cementitious ratio is considered.

In the “soils” approach, RCC is considered a cement-enriched, processed soil with a mix design based on moisture-density relationships. For a specified aggregate and cementitious materials content, an “optimum moisture content” is determined for a compaction stress corresponding to that applied by vibratory rollers in the field, to achieve a maximum density. Water contents, above or below optimum, will produce a lower dry density for a given compaction stress and, therefore, a reduced compressive strength.

Roller-Compacted Concretes based on the “concrete” approach will typically have a wetter consistency and a higher paste content than RCC based on the “soils” approach. High-paste mixes usually provide higher bond strengths at horizontal lifts and reduced permeability along lift lines due to the excess paste, which are both very desirable characteristics for concrete dam design. During the design of early RCC dams, both of these approaches were being used. However, in recent years there has been a swing towards the “concrete” approach in a similar way to the swing towards RCC containing higher cementitious contents. Nevertheless, the “soils” approach can and is still being used in project where it is considered suitable.



Figure 3.2.1: The aspect of RCC

3.2.1 CONCRETE APPROACH

All the methods that use the “concrete” approach follow similar procedures, although there can be some differences. The general procedure is as follows:

- Optimize the gradation/granulometry of the aggregates to produce minimum voids using additional fines if necessary
- Choose an appropriate paste/mortar ratio, so that the voids are filled or slightly over-filled
- Select the proper quantities of cement, additive (if any), water and admixture (if any) to obtain the required mean strength
- Establish the aggregates volume to obtain the required workability using the loaded Vebe apparatus
- Check that there is sufficient cementitious material (and the proportion of fines, if used) to provide the design permeability
- Make any adjustments that are necessary and re-check the design.

Sometime the minimum cost mix design is chosen for a project, depending on materials costs and sources.



Figure 3.2.1.1: A completed RCC dam

USACE Method

The following is a step-by-step procedure edited by “US Army Corps of Engineers (USACE)” for Roller-Compacted Concrete mix design.

After adequate proportions are established, the workability and strength of the RCC mixture should be verified in a laboratory by trial batching.

- STEP 1: determine all requirements related to the properties of the RCC mixtures, including strength and age, admixture requirements, expected exposure time and conditions, maximum size, source and quality of aggregates.
- STEP 2: obtain representative samples of all materials in sufficient quantities to provide verification tests by trial batching. Select the mix that will satisfy project requirements. From the materials submitted for the test program, determine the specific gravity and the absorption.
- STEP 3: from the Table 3.2.1.1 estimate the water requirement and entrapped air content for the maximum size of aggregate being used.
- STEP 4: compute the required equivalent mass of cement from the required compressive strength (from the USACE relationship). If pozzolan is used, compute the cement and pozzolan mass based on equivalent absolute volume of required cement.
- STEP 5: compute the required coarse aggregate proportions that best approximate the ideal coarse aggregate grading shown in Table 2.2.1.
- STEP 6: compare the available fine aggregate grading to the recommended fine aggregate grading shown in Table 2.2.2. From Table 3.2.2.1, select the fine aggregate percentage for the maximum size and type (crushed or rounded) aggregate being used.
- STEP 7: compute the absolute volumes and masses for all of the mixture ingredients from the information obtained in Steps 2 through 6.
- STEP 8: compute the mortar content and compare with values given in Table 3.2.2.1. Mortar volume includes the volume of all aggregate smaller than the 4.75 mm (No. 4) sieve, cementitious materials, water and entrapped air. Adjust fine aggregate content, if required.
- STEP 9: compute the volume of paste and the ratio of paste volume to mortar volume (V_p/V_m). The minimum V_p/V_m ratio should be greater than approximately 0.42 to ensure that all voids are filled. If required, adjust cementitious material content or increase quantity of aggregate.
- STEP 10: evaluate the workability and strength of the RCC mix by trial batching.

Table 3.2.1.1: Water content, sand content, mortar content, paste-mortar ratio, and entrapped air content for various nominal size aggregates. Typical values for use in estimating RCC trial mixture proportions (USACE)

Contents	Nominal Maximum Size of Aggregate ^a					
	19.0 mm		50 mm		75 mm	
	Average	Range	Average	Range	Average	Range
Water content^b, kg/m³						
a) Vebe <30 sec	150	133-181	122	107-140	107	85-128
b) Vebe >30 sec	134	110-154	119	104-125	100	97-112
Sand content, % of total aggregate volume						
a) crushed aggregate	55	49-59	43	32-49	34	29-35
b) rounded aggregate	43	38-45	41	35-45	31	27-34
Mortar content, % by volume						
a) crushed aggregate	70	63-73	55	43-67	45	39-50
b) rounded aggregate	55	53-57	51	47-59	43	39-48
Paste: mortar ratio, V_p/V_m, by volume	0.41	0.27-0.55	0.41	0.31-0.56	0.44	0.33-0.59
Entrapped air content on 37.5 mm fraction, %	1.5	0.1-4.2	1.1	0.2-4.1	1.1	0.5-3.3

- a Quantities for use in estimating water, sand, mortar and entrapped air content for trial RCC mixture proportioning studies.
- b Lower range of values should be used for natural rounded aggregates and mixtures with low cementitious material or aggregate fines content.

Table 3.2.1.2: Mix design for RCC (NMSA = 75 mm) using the USACE method

Mix Design for 1 m ³ RCC	Ratio	kg	kg/l	liters
Mix Design				1000
Cement		72	3.15	23
Air Voids	1 %	0	0.00	10
Fly-ash	0.47	34	2.14	16
Water	1.48	107	1.00	107
Aggregates	100%	2262	2.68	844
Sand (0 – 4 mm)	34 %	769	2.68	287
Gravel (4 – 75 mm)	66 %	1493	2.68	557

High-Paste Method

The “U.S. Bureau of Reclamation” developed this mix proportioning method for the “Upper Stillwater Dam” project. The resulting mixes from that testing program generally contained high proportions of cementitious materials (high pozzolan contents) and had high workability.

The purpose of the “Upper Stillwater Dam” mixes was to provide excellent lift-joint bond strength and low joint permeability, by providing sufficient cementitious paste in the mixture to enhance performance at the lift joints. The high paste method involves determining w/c and fly ash-cement ratios for the desired compressive strength level. The water, fine aggregates and coarse aggregates proportions are determined by initial trial batches. The Vebe consistency is in a range of 10 to 30 seconds.

Specific mix variations can be made to evaluate their effect on the fresh properties, such as consistency, and the hardened properties, such as compressive and tensile strengths.

Table 3.2.1.3: Mix design for RCC (NMSA = 50 mm) using the high-paste method

Mix Design for 1 m ³ RCC	Ratio	kg	kg/l	liters
Mix Design				1000
Cement		146	3.15	46
Air Voids	1.5 %	0	0.00	15
Fly-ash	2.19	320	2.14	150
Water	1.10	161	1.00	161
Aggregates	100%	1256	2.68	628
Sand (0 – 4 mm)	35 %	440	2.68	164
Gravel (4 – 75 mm)	65 %	816	2.68	464

RCD Method

The Roller-Compacted Dams method was developed by Japanese engineers and it is called “RCD” in order to distinguish it from other types of RCC dam construction methods. The reason is that this is considered as a different method.

The mix design approach is similar to the proportioning of conventional concretes, except that it incorporates the use of a consistency-meter. The consistency-meter is similar to the Vebe apparatus, whereby the RCC mixture is placed in a container and vibrated until mortar is observed on the surface. The procedure consists of determining the relationship between the consistency, termed the “VC value”, and the water content, unit weight of mortar, and the compressive strength. The right RCD mix is designed following these steps:

- Determination of the maximum size of aggregate. Usually NMSA 80 mm is adopted.
- Usually a cementitious content of 120 kg/m³ is adopted.
- Determination of sand aggregate ratio (30–35 %) that gives the RCD the lowest VC value.
- Determination of water content. A water content that gives the RCD a 20 second VC value is optimum. Usually 80 to 100 kg/m³ of water is required.

Table 3.2.1.4: Mix design for RCC (NMSA = 80 mm) using the RCD method

Mix Design for 1 m ³ RCC	Ratio	kg	kg/l	liters
Mix Design				1000
Cement		84	3.15	27
Air Voids	1.5 %	0	0.00	15
Fly-ash	0.43	36	2.14	17
Water	1.19	100	1.00	100
Aggregates	100%	2234	2.68	841
Sand (0 – 4 mm)	33 %	737	2.68	278
Gravel (4 – 80 mm)	67 %	1497	2.68	563

Because of the consistency test equipment requirements and differences in the nature of RCD design and construction, this method is not widely used for RCC outside of Japan.

3.2.2 “SOILS” APPROACH

Maximum Density Method

Soil compaction method is a geotechnical approach similar to that used for selecting the proportions of soil-cement mixtures. This approach, with the mixture determined by optimum moisture content and maximum dry density, is the most common for RCC pavements in the U.S. The desired water content is determined by moisture-density relationship of compacted specimens, generally using ASTM D 1557.

In this method, a series of mixes for each cementitious materials content are prepared and batched using a range of water contents. Each prepared mix is compacted with a standard load. The maximum density and optimum water content are determined from a plot of the measured density versus water content for the compacted specimens. The actual water content used is usually slightly higher (plus approximately 1%) than the optimum value determined in the laboratory, in order to compensate for the moisture loss during transport, placing and spreading.

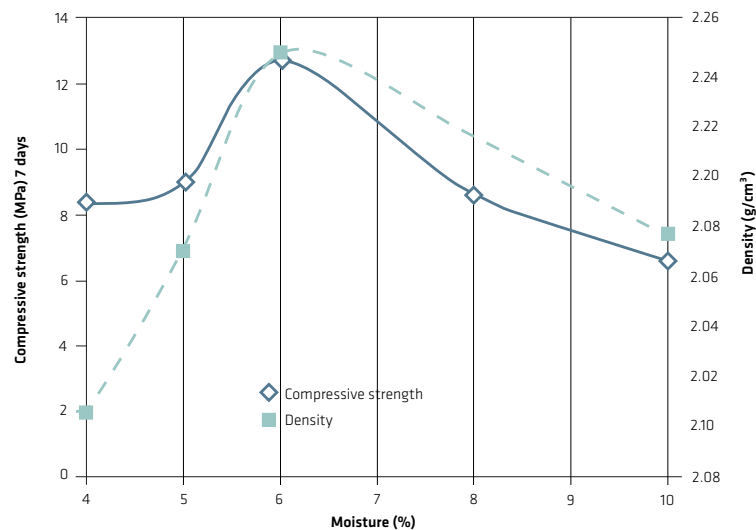

Figure 3.2.2.1: Moisture-density relationship (optimum water content)

The right mix is designed by the following process:

- Choose well-graded aggregates. The gradation of the combined aggregates should approach a maximum-density grading.
- Select the cementitious content. Based on the project specifications, economic and the availability of materials/production considerations.
- Develop moisture-density relationship plots. For a fixed cementitious materials percentage, different moisture contents are selected to develop a moisture-density plot. For most aggregates, the optimum moisture content is found to be within the suggested range of 5 to 8 %.

- Test specimens and select the required cementitious content. The specimens are tested to determine compressive strengths at the selected cementitious contents. The data is plotted and a compressive strength versus cementitious content curve is developed.
- Calculate mix proportions. After the final selection of the cementitious content and optimum moisture content, the final mix proportions can be calculated for the project. Saturated surface-dry (SSD) condition of the aggregates should be used when determining the weight and corresponding volume calculations.

Table 3.2.2.1: Mix design for RCC (NMSA = 80 mm) using the RCD method

Mix Design for 1 m³ RCC	Ratio	kg	kg/l	liters
Mix Design				1000
Cement		216	3.15	68
Air Voids	0 %	0	0.00	0
Fly-ash	0.26	56	2.14	26
Water	0.55	119	1.00	119
Aggregates	100%	2109	2.68	787
Sand (0 - 4 mm)	52 %	1097	2.68	409
Gravel (4 - 38 mm)	48 %	1012	2.68	378



Figure 3.2.2.2: RCC spreading

3.3 REFINEMENT OF MIX PROPORTIONS

3.3.1 LABORATORY TRIAL MIXES

As previously mentioned, it is recommended that a series of mixtures are proportioned and investigated in laboratory trial mixes to verify the performances and observe their tendency to segregate. This practice will allow later modifications or adjustments of the mix proportions without necessarily repeating these trials.



Figure 3.3.1.1: Laboratory trial cylinders of RCC

Laboratory tests, such as the ones described in the next chapter, should be conducted on the RCC specimens of each trial mix. Different trial cylinders should be prepared for compressive strength testing at various ages, usually 7, 14, 28, 56, 90, 120, 180 days and 1 year, to derive the strength-gain characteristics of each mix. These specimens can also be used for the determination of Static Modulus of Elasticity and Poisson's ratio. Additional specimens can also be manufactured for indirect (Brazilian) tensile strength and/or direct tensile strength testing. On larger major projects, other specimens are also manufactured from the different RCC mixes to test the thermal properties and other parameters such as creep, strain capacity and shear strength for example.

3.3.2 SITE LABORATORY TRIAL MIXES

The primary purpose of laboratory trial mix programs is to provide proportions that when batched, mixed and placed in the field, will perform as intended. However, laboratory conditions seldom duplicate field conditions perfectly, but in spite of the differences, laboratory trial mix programs have proved to be an effective means of evaluating the potential RCC performance and thereby minimize adjustments on site.

3.3.3 FULL-SCALE TRIALS

Prior to starting the main construction works, it is strongly recommended that the proposed RCC is mixed in the actual concrete plant and then placed, spread and compacted in a full-scale trial using the same equipment and procedures intended for the dam construction.

A full-scale trial can also be used to visually examine the segregation potential of the RCC mix under the specific site conditions, the condition of the lift surfaces, the necessary treatment for those surfaces and any other aspects of construction that may require review.

3.4 TYPICAL MIX PROPORTIONS

Table 3.4.1 contains details of the mix proportions for each type of RCC dam, based on the results from the majority of the RCC dam projects completed and/or under construction.

The cement contents of the low-cementitious and medium-cementitious RCC dams are very similar; the major difference between these two types is the additive content. The high-cementitious and RCD dams have higher cement contents and lower water contents than the other two types of RCC dam. In the RCD dams this is possibly due to the use of additives and in the high-cementitious content dams, it is due to the very much higher additive content.

In the lower part of the table are the average values of the pozzolan/cementitious ratio and the water/cement ratio.

Table 3.4.1: Typical RCC mix contents

Classifications	Low-Cementitious	RCD	Medium-Cementitious	High-Cementitious
<i>Cement content (kg/m³)</i>				
Minimum	-	42	-	46
Maximum	95	96	125	154
<i>Additive content (kg/m³)</i>				
Minimum	-	24	-	40
Maximum	90	78	130	225
<i>Water content (kg/m³)</i>				
Minimum	87	75	95	73
Maximum	168	110	145	136
Pozzolan/cementitious ratio	0.17	0.28	0.48	0.57
Water/cement ratio	2.68	1.81	1.92	1.05

4 LABORATORY TESTS

4.1 GENERAL

There are numerous laboratory tests to evaluate the wide range of consistencies, mix proportions and aggregate gradation of Roller-Compacted Concrete. Some tests are adapted from conventional concrete procedures, whilst others are adapted from soil-cement or earthworks technology.

Before mixing RCC, all components should be checked to confirm that they meet the project specification requirements. Laboratory tests are performed using the actual project materials to determine the RCC's real fresh and hardened properties. There is no single set of these tests that applies to all RCC mixes; Table 4.1.1 summarizes some of the most frequently used quality control tests for RCC and its components..

Table 4.1.1: Some of the most frequently used QC tests for RCC

Material tested	Test procedure	Test standards	Frequency*
Cement	Physical/chemical properties	ASTM C 150 or equivalent	Manufacturer's certification or prequalified
Pozzolan	Physical/chemical properties	ASTM C 618 or equivalent	Manufacturer's certification or prequalified
Admixtures	-	ASTM C 260 ASTM C 494	Manufacturer's certification
Aggregates	Specific gravity absorption	ASTM C 127 ASTM C 128	1/month
	Grading	ASTM C 117 ASTM C 136	1/shift or 1/day
	Moisture content	ASTM C 70 ASTM C 566	Before each shift/or as required
	Flat/long particles	-	1/month or 7500 m ³
	Plasticity of fines	-	1/month or 7500 m ³

Material tested	Test procedure	Test standards	Frequency*
RCC	Consistency and density	ASTM C 1170	2/shift or as required
	In-place density	ASTM C 1040	1/hr or every 200 m ³
	In-place moisture (double-probe, nuclear gage only)	ASTM C 1040	1/hr or every 200 m ³
	Oven-dry moisture	ASTM C 566	1/shift or every 750 m ³
	Mix proportions – RCC mix variability	ASTM C 172 ASTM C1078 ASTM C1079	1/week or every 4000 m ³
	Temperature	ASTM C 1064	½ hr or every 400 m ³
	Compressive strength	ASTM C 39 ASTM C 1176	½ hr or every 400 m ³
	Split tensile strength	ASTM C 496	1/day or every 4000 m ³
Elastic modulus	ASTM C 469	1/day or every 4000 m ³	

* The frequency is recommended by USACE and ICOLD Bulletin 126



Figure 4.1.1: A RCC dam under construction

4.2 FRESH RCC PROPERTIES AND TESTS

4.2.1 VEBE CONSISTENCY

Vebe consistency is an indicator of the workability of RCC, according to ASTM C 1170. In this test a sample of RCC is vibrated under a surcharge until it is fully consolidated. The time required to consolidate the sample is a function of the relative workability of the RCC and it is called the “Vebe time”. The lower the “Vebe time” or consistency time, the easier it is to compact the sample. The typical range of consistency times for RCC mixtures, using the “concrete approach” for proportioning, is from about 10 to 60 seconds; 10-25 seconds were normally used for workable mixes.

The Vebe consistency test for RCC basically replaces the slump test used for conventional concrete (Table 4.2.1.1 shows a comparison of the two methods). The Vebe Consistometer has been the most common vibrating table used for this test. Once a specific Vebe time is established, the normal procedure is to maintain a constant Vebe time by making water adjustments to compensate for changes in aggregates, moisture content or temperature. The water adjustments should be made if and when, two consecutive Vebe readings vary from the target Vebe time by 10 seconds or more. Changes to the established Vebe time are only allowed if required to improve compactability and the resulting density.

Table 4.2.1.1: The comparison of consistencies measured by slump and Vebe apparatus

Consistency	Slump (mm)	Vebe (s)
Extremely dry	-	32 to 18
Very stiff	-	18 to 10
Stiff	0 to 25	10 to 5
Stiff plastic	25 to 75	5 to 3
Plastic	75 to 125	3 to 0
Very plastic	125 to 190	-



Figure 4.2.1.1: A sample of RCC (“concrete approach”) before Vebe testing



Figure 4.2.1.2: A sample of RCC (“concrete approach”) after Vebe testing

ASTM C 1170

This test method is used to determine the consistency of concrete by the Vebe Consistometer apparatus and the density of the consolidated specimen. It is applicable to freshly mixed concrete having a nominal maximum size of aggregate of 50 mm or less. If the NMSA is larger than 50 mm, the method is applicable only when performed on the fraction passing the 50-mm sieve with the larger aggregate being removed in accordance with ASTM C 172.

Consistency is measured, using a Vebe vibrating table, as the time required for a given mass of concrete to be consolidated by vibrating it in a cylindrically shaped mould. Density of the compacted specimen is evaluated by determining the mass of consolidated specimen and dividing by its volume, which is determined using water-displacement methods.

This test method and procedure is particularly useful and specified for determining the consistence and density of stiff to extremely dry concrete mixtures, such as RCC mixtures.

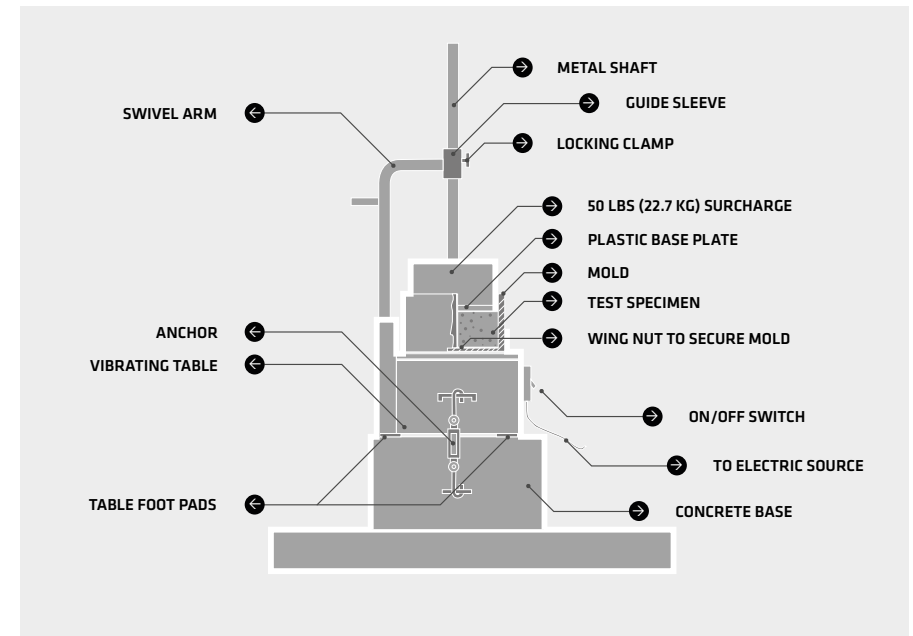

Figure 4.2.1.3: Vebe apparatus

The procedure is as follows:

1. Using a small square-ended shovel, form a representative sample in accordance with the ASTM C 172. Place and distribute the RCC evenly to minimize segregation. Level the surface of the loosely placed concrete.
2. Secure the mould on the Vebe table by tightening the wing nuts. Slide the shaft of the surcharge mass through the guide sleeve and rotate the surcharge to its locked position centred over the mould, ensuring that it will fit inside the mould when released.
3. Start the vibrator and timer. Using a flashlight, observe the concrete in the annular space between the edge of the surcharge and the inside wall of the mould. As the test progresses, mortar will fill the annular space between the outer edge of the surcharge and the inside mould wall. Observe until the mortar forms a ring around the total perimeter of the surcharge.
4. When the mortar ring forms completely around the surcharge, stop the vibrator and timer. Determine the elapsed time and record this time as the "Vebe consistency time".

4.2.2 DENSITY

After the Vebe test, it is possible to determine the density of RCC with the following procedure (in accordance with ASTM C 1170):

1. After the determination of the "Vebe time", remove the surcharge weight. Vibrate the specimen (without the surcharge) for a total cumulative time of 2 minutes.
2. Remove the mould with the consolidated specimen from the Vebe table and wipe any mortar from the inside wall of the cylindrical mould.
3. Determine the mass of the specimen by subtracting the mass of the cylindrical mould and flat plate from the mass of the mould, consolidated specimen and flat plate.
4. Place the mould on a level surface and carefully fill it with water (at room temperature) to a level just above the top rim.
5. Carefully cover the mould with the flat plate in such a way as to eliminate air bubbles and excess water.
6. Remove all excess water and determine the total mass of the specimen. Calculate the mass of the water by subtracting the mass of the mould, specimen and plate from the total mass.
7. Calculate the volume of water (by dividing the mass of water by the density of water) and the volume of the specimen (by subtracting the volume of the water obtained from the volume of the cylinder mould).
8. Determine the density of the specimen: $D = M_s / V_s$ (mass of specimen)/ V_s (volume of specimen).



Figure 4.2.1.4: RCC sample after consolidation with Vebe apparatus



Figure 4.2.2.1: The determination of the total mass of the cylindrical mould, consolidated specimen, water and flat plate

Nuclear Methods

The density of RCC can be determined indirectly in situ with a calibrated nuclear density gauge. Two types of apparatus are available for the nuclear test: a single-probe and a double-probe nuclear density gauge. Testing may take from 5 to 15 minutes, depending on the number of depths at which densities are checked. This method is more costly and more time consuming to use than the ASTM C 1170 proposed method.

The density measured by nuclear gauges is affected by the chemical composition of the concrete constituents and it may not be the true density. The gauge must be corrected for chemical composition error by determining the true density of fresh RCC compacted to different densities in a rigid calibrated container, according to ASTM C 1040 or another acceptable standard, and comparing that density to the density indicated by the gauge.

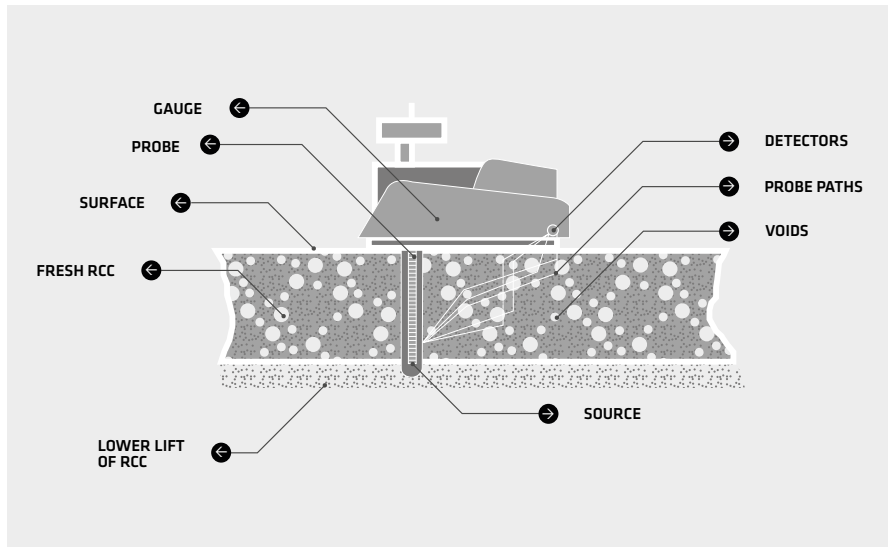

Figure 4.2.2.2: Single-probe nuclear density gauge (ACI, American Concrete Institute)

4.2.3 MOISTURE/WATER CONTENT

The moisture or water content is important for several reasons: to determine the w/c ratio, to ensure the optimum or desired moisture content for workability and compaction, and also as one of the indicators for mix uniformity. The most frequent moisture tests are:

- Chemical tests
- Drying tests
- Nuclear tests

ASTM C 1079

Chemical tests can be performed on samples obtained before or after compaction. Two chemical tests are given in ASTM C 1079, but they have not been widely used on RCC projects.

ASTM C 566 - ASTM D 4643 - ASTM D 4959

Drying tests include hot-plate, standard oven, or microwave oven testing to remove the water from a representative sample. These tests are adapted from soil and aggregate testing. It has become common on some projects to test the moisture content in order to obtain an indication of how much water is being added or lost under the construction conditions. The hot-plate and standard oven tests are the most common and reliable drying tests for RCC.

ASTM D 3017

When used to determine moisture content, the nuclear gauge measures hydrogen content, which is strictly related to water content of the mix, and it is normally determined on compacted RCC. The results can be affected by stratification of moisture in the RCC layers and for this reason the moisture content should be computed as the average of the bottom, midpoint and top readings of the layer.

4.2.4 AIR CONTENT

The compacted air content and unit weight of a fresh RCC mix should be determined with a pressure air meter. When this type of test is required by the project specifications, Type B air meters, according to ASTM C 231, are most commonly used.

ASTM C 231

This test method covers determination of the air content on freshly mixed concrete from observation of the change in volume of the concrete with a change in pressure. RCC is screened over the 37.5-mm sieve, placed into the air meter in three equal-volume layers and consolidated by a Vebe table or vibrating hammer. The air meter can also be used to determine the density prior to testing for the air content. The formula for the calculation of the air content is the following:

$$A_s = A_1 - G$$

where:

A_s = Air content of the sample tested, (%)

A_1 = Apparent air content of the sample tested, (%)

G = Aggregate correction factor (the procedure for its evaluation is explained in the sixth paragraph of ASTM C 231), (%)

The air content for good quality RCC, as evidenced from many projects, should be in the range of 0.5% to 1.5%.

4.2.5 SETTING TIME

ASTM C 403/C 403M

This test method covers the determination of the setting times of concretes with slump greater than zero, measured by means of the penetration resistance in mortar sieved from the concrete mix.

The sieved mortar is placed in a container (cylindrical or rectangular) and stored at a specified ambient temperature. At regular time intervals, the resistance of the mortar to penetration by standard needles is measured. From a plot of the penetration resistance versus elapsed time, the times of the initial and final setting are determined.

For each plot, the times of initial and final setting are determined as the times when the penetration resistance is 3.5 N/mm² and 27.6 N/mm², respectively. They result from the following formula:

$$PR = ct^d$$

where:

PR = Penetration resistance

t = Elapsed time

c and ^d = Regression constants

For RCC mixtures containing retarders, the initial test may be deferred until an elapsed time of 4 to 6 hours (depending on dosage of the admixture). Subsequent tests should be made at ½- to 1 h intervals.



Figure 4.2.4.1: Air meter (ASTM C 231 – Type B) for air content test



Figure 4.2.5.1: Reading of a penetration test on a RCC specimen

4.2.6 CEMENT CONTENT

ASTM C 1078 can be used to determine the cement content of freshly mixed concrete by chemical titration or calcium ion analysis. The sample size and some specifics of the samples preparation have been modified to facilitate the procedures with RCC mixes. The heat of neutralization test (ASTM D 5982) has also been used to determine the cement content of freshly mixed concrete, but it has resulted in problems with high variability and premature hardening of the RCC samples on some projects.

4.2.7 SEGREGATION POTENTIAL

It is necessary to produce a RCC mix with minimum tendency to segregate, as the segregation of coarse aggregates leads to poor bond and excessive water seepage between subsequent RCC layers, and also to an increased volume of voids between aggregates. A mix that is too dry, combined with poor handling and placing techniques, is the main cause of the segregation with RCC. Mixes with a Vebe consistency less than 20-25 seconds generally have less segregation than mixes with a higher consistency time.

4.2.8 TEMPERATURE

The fresh RCC temperature should not be too low, so that the concrete gains sufficient strength fast enough and does not suffer damage from frost at an early age. The placement temperature of fresh RCC influences the mix workability, the setting time, and it can also influence the bond potential between layers.

Temperature monitoring should be performed at least daily. When daily ambient air temperatures rise significantly above or below the allowable range of temperature for the RCC (established in the project specifications), more frequent readings should be taken and recorded for both RCC and ambient air temperatures.

4.3 HARDENED RCC PROPERTIES AND TESTS

4.3.1 REQUIREMENTS FOR SPECIMENS AND MOULDS

Procedures for preparation of Roller-Compacted Concrete test specimens are different to that for conventional concretes due to the mix consistency and the maximum aggregate size (NMSA).

High-cementitious mixes with a Vebe time less than about 30 seconds, are suited to consolidation by ASTM C 1176. This procedure uses a vibrating table similar to the Vebe apparatus and a surcharge weight. Mixtures that have Vebe time in excess of approximately 20 seconds, or that do not respond at all to the Vebe test, can be compacted by other procedures using various models of the Hilti or Kango vibrating hammer. This practice is extensively discussed in ASTM C 1435.

Moulds

Two types of mould are provided for making RCC test cylinders: a steel reusable mould or a single-use plastic mould inserted into a metal cylinder.

The first type is a cylindrical mould, conforming to the requirements of ASTM C 470, of 152 mm in diameter and 305 mm in height. It is made of steel or other hard metal that does not react with concrete and equipped with permanently affixed slotted metal brackets on the baseplate, so that it can be fixed rigidly to a vibrating table. The second type is a single-use plastic cylindrical mould of equal dimensions to the first type, and in accordance with ASTM C 470. It is inserted into a steel cylindrical sleeve with the precise dimensions and thicknesses specified.



Figure 4.3.1.1: Steel moulds (on the left) and single-use plastic moulds with steel sleeves (on the right)

ASTM C 1176

This covers the procedures for making the cylindrical test specimens of concrete, when the standard procedures of compacting and internal vibration, as described in ASTM C 31, are not practicable. It is applicable to freshly mixed RCC, prepared in the laboratory or on site, having a NMSA of 50 mm or less. If the nominal maximum size aggregate is larger than 50 mm, the test is applicable only when performed on the fraction passing a 50-mm sieve, with the larger aggregate being removed in accordance with ASTM C 172.

This standard describes methods for making cylindrical concrete test specimens using a Vebe vibrating table. Test specimens are made in a cylindrical mould that is attached to the vibrating table under a 9.1 kg surcharge to facilitate consolidation. A summary of the standard procedure is shown below:

1. Coat the mould with a suitable release agent prior to casting the test specimens to facilitate their removal from it.
2. Place the mould on the vibrating table and centre the surcharge. Attach the mould to the vibrating table and firmly tighten the wing nuts.
3. Place enough concrete in the mould so that it will be filled to one-third of its volume after consolidation. During this filling use square-ended shovels to obtain representative samples.
4. Place the surcharge on the loose concrete and start the vibrator table. Using a flashlight, observe the concrete in the annular space between the edge of the surcharge and the inside wall of the mould. As the concrete consolidates, mortar will fill in the annular space between the outer edge of the surcharge and the inside mould wall. Observe the mortar until it forms a ring around the total perimeter of the surcharge. When the mortar ring is fully formed, stop the vibrator table.
5. Repeat these steps 3 to 5 for the second and the third layer of concrete then remove the mould with the consolidated specimen and finish the top surface with a steel trowel.

The procedure shown is fine for moulds of both the first type and the second one.



Figure 4.3.1.2: RCC sample after consolidation with Vebe apparatus

ASTM C 1435

This practice covers moulding cylindrical concrete test specimens using a vibrating hammer and a circular steel plate. RCC test specimens are moulded vertically in cylindrical moulds by compacting the mixture in three different layers. A summary of the procedure is shown below:

1. Coat the moulds with a suitable release agent prior to casting the test specimens.
2. Hold the mould stationary by fixing to a rigid base and centre the vibrating hammer so that the edges of the tamping plate do not touch the walls of the mould.
3. Place enough concrete in the mould so that it will be filled to one-third of its volume after consolidation.
4. Place the vibrating hammer with tamping plate onto the concrete, start the vibrating hammer and allow the concrete to consolidate under the circular plate. As the concrete consolidates, mortar should fill in the annular space between the outer edge of the tamping plate and the inside mould wall. Observe the mortar until it forms a ring around the total perimeter of the tamping plate. When the mortar ring forms completely, stop the vibrating hammer.
5. Repeat this procedure for the second and the third layers of concrete fill and then remove and finish the top surface with a steel trowel.



Figure 4.3.1.3: An example of vibrating compaction hammer (on the left) and of the moment when mortar paste came up around the total perimeter of the circular steel plate (on the right)

4.3.2 COMPRESSIVE STRENGTH

Although it is not necessarily the most important design criterion, the compressive strength is a good indicator of an RCC mix's other properties, such as durability, and it is also a useful tool to evaluate mix variability. The design compressive strength is normally specified for most RCC dam projects. It is determined by a compression test on specially produced specimens or cores from the dam body. Tests of concrete cores may be used to help evaluate the RCC's long-term performance and the effects of the compaction methods.

RCC compressive strength is primarily affected by: cement content, type of cementitious materials, aggregate quality and grading, plus the degree of compaction achieved. The common practice for RCC dams is to cast a set of specimens every 4000 m³ and compressive tests on them are usually made at 3, 7, 14 (for accelerated curing test), 28, 56 and 90 days (plus 180 days and 1 year for long-term performance). Typical RCC mixes produce compressive strength ranging from 6.9 to over 27.6 N/mm² at 1-year age. For seismic areas higher design compressive strength is often required, in order to also achieve higher tensile and shear strengths.



Figure 4.3.2.1: Tensile strength test on a cylindrical specimen of RCC

ASTM C 39

This test method covers the determination of compressive strength of cylindrical concrete specimens such as moulded cylinders and drilled core samples. It is limited to use on concrete having a unit weight in excess of 800 kg/m³.

This test method consists of applying a compressive axial load to cylinders or cores at a rate that is within a prescribed range until failure occurs. The testing machine must be capable of providing the rates of loading prescribed in the ASTM.

The compressive strength of the specimen is calculated by dividing the maximum load achieved during the test by the cross-sectional area of the specimen.

The compressive load has to be applied until the load indicator shows that the load is decreasing steadily and the specimen displays a well-defined fracture pattern (Figure 4.3.2.2).

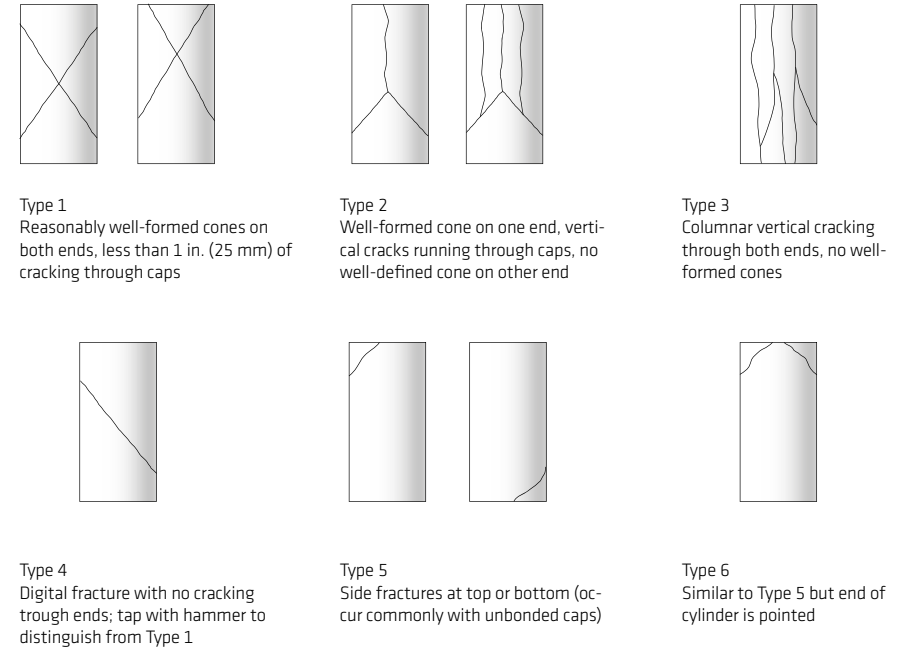

Figure 4.3.2.2: Fracture patterns according to ASTM C 39

The results of this test are used as the basis for quality control of RCC proportioning, mixing, placing and compacting operations; plus controls for evaluating the effectiveness of admixtures and other similar uses. Table 4.3.2.1 shows an example of the test results obtained on three different samples from a Sika RCC dam project. The RCC mix in these samples on the table was obtained with a "concrete" mix design approach.

Given the rapid rates of construction, verification of the concrete strength before a layer is covered is difficult. For some dams, a set of RCC cylinders, which are heat cured in an oven or by hot water immersion, is tested after 24 hours ("accelerated cure"). Data from the full-scale trial can then be used to correlate these early strengths to the specified 28-day or 90-day compressive strength requirements.

Table 4.3.2.1: An example of compressive strength test results of RCC samples at 90 days

Sample No.	SS01		SS02		SS03	
	3	4	3	4	3	4
Cylinder No.						
Age	90 days					
Diameter (mm)	148.0	150.2	150.0	150.0	149.6	149.8
Length (mm)	298.2	300.8	291.95	300.9	294.95	294.05
Weight in Air (g)	12553	12744	12440	12873	12454	12446
Weight in Water* (g)	7242	7369	7226	7453	7197	7184
Density (kg/m ³)	2364	2371	2386	2375	2369	2365
Max. Load (kN)	192.3	194.4	244.3	249.9	224.5	246.8
Compressive Strength (N/mm ²)	10.9	11.0	13.8	14.1	12.7	14.0

* The weight of water displaced by the concrete sample

Coefficient of Variation

As with conventional concretes, the RCC test results are statistically evaluated and compared with the design requirements. One method of control is to review the Coefficient of Variation (Cv) of the in-situ RCC by testing cores from the dam structure. This is more generally and widely used on RCC dams than standard deviation, due to the relatively low-strength mixes that are commonly involved.

This coefficient usually ranges from 5% (excellent quality control) to 45% (very poor quality control). This wide variation could result from a number of different factors:

- Content of cement
- Type and content of cementitious material
- Water (moisture) content
- Content of fines
- Control of compaction (density)
- Quality control at the concrete plant
- Mixer efficiency

Careful curing and handling of the test specimens is also important to reduce any additional variation in the Coefficient of Variation of compressive strength. Table 4.3.2.2 shows the typical ranges of Cv in percentage.

Table 4.3.2.2: Coefficients of Variation of compressive strength relative to the perceived level of quality control

Compressive Strength (at design age)	Ranges of Coefficient of Variation (%)				
	Excellent	Good	Average	Poor	Very Poor
Manufactured specimens	< 10	10 to 15	15 to 20	20 to 25	> 25
Cores/in-situ specimens	< 15	15 to 20	20 to 25	25 to 30	> 30

4.3.3 TENSILE STRENGTH

Tensile strength is generally the principal structural concrete concern for the design of a RCC dam. Tensile strength can be measured by several methods, including the direct tension method, the splitting tensile method (ASTM C 496) and the flexural test, or modulus of rupture, method (ASTM C 78). The tensile strength of RCC is dependent on cementitious material content, aggregate bond characteristics with the cement paste, the degree of compaction, the surface condition of the different layers and their treatment.

The layer joints are critical points in the construction of RCC dams, as they are for conventional concrete dams, and as a consequence, the tensile strength at the layer / lift joints is an important performance requirement for these structures. Direct tensile strength (also called “bond strength”) is the most pertinent tensile strength test for these layer / lift joints. Split tensile testing of horizontal cores has also been used to establish this joint strength; however, the identification and locating of the joint in the central portion of the core is very difficult.

Direct tensile strength

Direct tension strength test results for RCC are usually at lower levels than for splitting tensile tests (25 to 30 percent lower) and these can be assumed to represent the minimum tensile properties of the concrete. When compared with splitting tensile tests, these direct tension tests are even more difficult to conduct and control, therefore they produce more variable test results. Because of these problems, the splitting tensile test has historically been more commonly used to evaluate the tensile strength of RCC mixtures.

The direct tensile strength results from a number of projects, using both cores and cylinders, have generally ranged from six to eight percent of the compressive strength.



Figure 4.3.3.1: Specimens to measure the direct tensile strength of horizontal joints from an RCC with low-cementitious material

Splitting tensile strength

Splitting tensile strength is generally greater than the direct tensile strength as mentioned, and it is lower than the flexural strength (modulus of rupture). Splitting tensile tests can provide more consistent results than direct tensile tests.

This test method, according to ASTM C 496/C 496M, consists of applying a diametrical compressive force along the length of a cylindrical RCC specimen at a rate, which is within a prescribed range, until failure occurs. This loading induces tensile stresses on the plane containing the applied load and relatively high compressive stresses in the area immediately around the applied load. The failure plane is normally forced to occur through a narrow area along the specimen's longitudinal axis.

Table 4.3.3.1 shows an example of the splitting tensile strength test results obtained on two real RCC samples (RCC dam project with Sika admixtures - "concrete" approach). Calculate the splitting tensile strength as follows:

$$T = 2P/\pi ld$$

where:

T = Splitting tensile strength [N/mm²]

P = Maximum loading indicated by testing machine [N]

l = Length of line of contact of the specimen [mm]

d = Height of specimen as tested [mm]

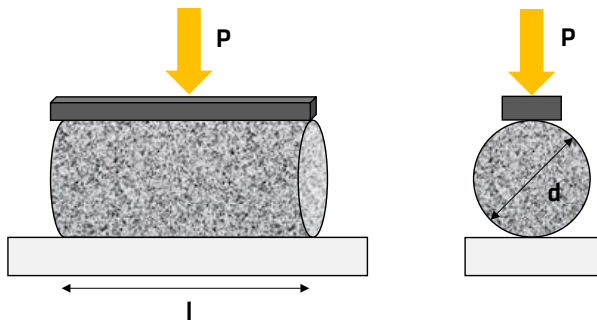

Figure 4.3.3.2: Splitting tensile strength test

Table 4.3.3.1: Tensile splitting strength test results from a Sika reference project

Mix Ref.	SS04	SS05	SS04	SS05
Age of Concrete at Test (days)	28		90	
Specimen Dimensions	150 mm (Diameter) x 300 mm (Height)			
Weight (kg)	12.9	12.6	12.8	12.7
Density (kg/m ³)	2422	2407	2405	2410
Length of Line of Contact of Specimen (mm)	299.8	299.8	300.7	296.9
Height of Specimen as Tested (mm)	150.2	149.7	150.0	149.8
Maximum Load (kN)	101.7	100.8	103.8	111.0
Tensile Splitting Strength (N/mm ²)	1.4	1.4	1.5	1.6
Type of Fracture	Normal	Normal	Normal	Normal

Flexural strength

Flexural strength, or modulus of rupture, is a measure of the tensile strength, though it is not generally used for RCC dam structures. In addition, the flexural strength does not evaluate the tensile strength at lift joints. Roller-Compacted Concrete has a flexural strength that is strongly dependent on the mix proportions and the critical factor is the bond between the aggregates and the hydrated cement.

The variation with this test is higher than with the tensile and compressive strength tests. The results may be used, but should be confirmed by testing significant structures. RCC, as with conventional concretes, generally has a flexural strength of from 2 N/mm² to 7 N/mm².

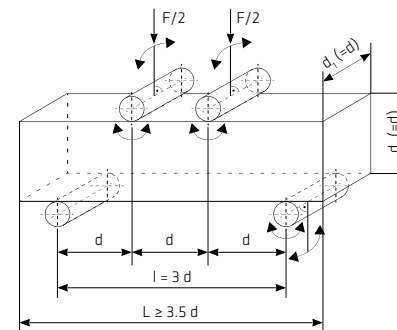

Figure 4.3.3.3: Two-point load transfer

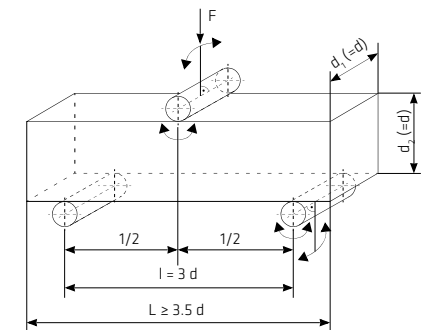

Figure 4.3.3.4: Central load transfer

4.3.4 YOUNG'S MODULUS OF ELASTICITY (E-MODULUS)

Young's Modulus of Elasticity (also known as the E-Modulus) describes the hardened RCC performance regarding its elastic deformation resistance. E-Modulus describes the relation between an influencing stress and the corresponding elastic deformation of the material (stress-strain relation).

Properly proportioned and consolidated RCC should provide a Modulus of Elasticity equal to or greater than that of conventional concrete. Principal factors affecting the elastic properties of RCC are age, strength, paste volume and aggregate type. Test ages of 3, 7, 14, 28, 56, 90, 180, and 365 days may be considered.

Static Modulus of Elasticity according to ASTM C 469

This test method covers determination of the chord modulus of elasticity of moulded concrete cylinders and drilled concrete cores when under longitudinal compressive stress. The procedure for evaluation of the static E-Modulus offers a stress to strain relation and a ratio of lateral to longitudinal strain for hardened RCC. RCC values of E-Modulus tend to have a wider range than for conventional concrete at all ages. The E-Modulus is calculated by the same formula as with conventional concretes:

$$E = (S_2 - S_1) / (\epsilon_2 - 0.000050)$$

where:

E = Chord modulus of elasticity (N/mm²)

S₂ = Stress corresponding to 40% of ultimate load

S₁ = Stress corresponding to a longitudinal strain, ϵ_1 , of 50 millionths

ϵ_2 = Longitudinal strain corresponding to stress S₂

Poisson's Ratio

Poisson's ratio is defined as the ratio of the lateral to the longitudinal strain resulting from a uniformly distributed axial stress and is determined according to ASTM C 469. Poisson's ratio for RCC is the same as for conventional concrete. For static loads, most values range between 0.17 and 0.22.

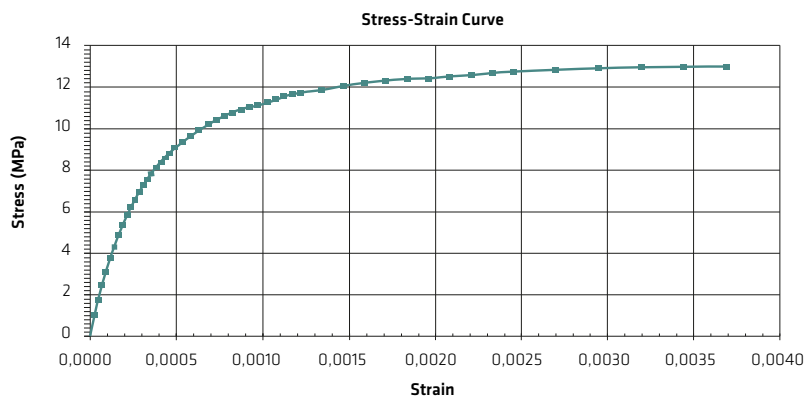

Figure 4.3.4.1: Example of a stress-strain curve for RCC ("concrete" approach) cylinder at 90 days

4.3.5 CREEP

Creep is defined as the deformation of concrete under a continuous load, usually elastic and long-term. Creep parameters were determined from tests on RCC specimens under constant compressive load. Creep is closely related to the Modulus of Elasticity, compressive strength of the concrete and it is also a function of the age of the concrete at the time of loading.

Generally, higher-strength mixtures have a more rigid matrix and lower creep, whereas low strength mixtures will produce concretes with higher creep. The test method recommends five ages of loading between 2 days and a year to fully define creep behaviour.

ASTM C 512

This test method measures the load-induced time-dependent compressive strain at selected ages for RCC under an arbitrary set of controlled environmental conditions. ASTM C 512 standard represents creep by the following formula:

$$\epsilon = (1/E) + F(K) \ln(t+1)$$

where:

ϵ = Total strain (N/mm²)

E = Instantaneous elastic modulus (N/mm²)

F(K) = Creep factor, calculated as the slope of a straight line representing the creep curve

t = Time after loading, (days)

The first part of the formula (1/E) represents the initial elastic strain from loading and it is determined from the strain readings taken immediately before and after loading the specimen. The second one represents the long-term effects of creep after loading.

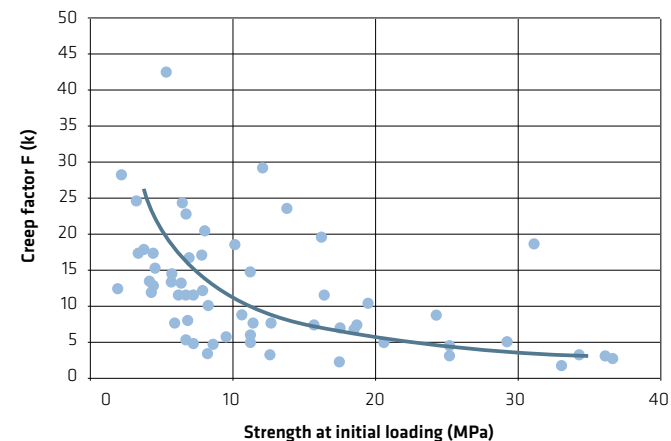

Figure 4.3.5.1: Creep factor vs. strength at initial loading (various mixes from several projects)

4.3.6 DURABILITY

Like conventional concretes, RCC is subject to potential deterioration by the effects of abrasion/erosion, freeze-thaw action, and other exposure factors such as sulphate attack.

Abrasion/erosion (ASTM C 1138)

Abrasion/erosion resistance is primarily governed by the concrete compressive strength and aggregate quality. Caution is suggested for RCC in areas of high-velocity water flows across RCC dam spillways, which can create erosion.

However, spillways subject to frequent high-velocity water flows are typically faced with higher strength conventional concrete. ASTM C 1138 has been used to evaluate the erosion resistance of both conventional concrete and RCC.

Freeze-thaw action (ASTM C 666)

RCC mixes do not normally have intentionally entrained air and consequently will not have a high freeze-thaw resistance, especially not in a critical saturated moisture condition.

Laboratory investigations and field applications have shown that an air-entraining admixture can effectively establish an air-void system with increased resistance and good performance against freeze-thaw, even when subjected to ASTM C 666 testing. Most RCC mixes require a high dosage of air-entraining admixture to be effective in this respect.

4.3.7 PERMEABILITY

Permeability of the horizontal layers is a key element for the performance of RCC in hydraulic structures. The permeability is largely dependent upon the level of voids in the compacted mass and therefore it is almost totally controlled by mix proportioning, placement method, use of a bedding mortar/concrete bonding layer on lift surfaces and the degree of compaction.

High cementitious RCC mixes tend to have lower permeability than low cementitious content mixes. The permeability of RCC cylinders and cores can be tested using CRD-C 163 (by US Army Corps of Engineers), "Test Method for Water Permeability of Concrete Using Triaxial Cell". This test method produces a value of "intrinsic permeability (k)" which must be converted to the more commonly used "coefficient of permeability (K)" by standard practice.

4.3.8 VOLUME CHANGE

Drying Shrinkage

Drying shrinkage is governed by the water content and by the degree of the aggregates moisture absorption. Compared to conventional mass concrete, the volume change from drying shrinkage in RCC is similar or lower because of the reduced water content. Drying shrinkage is commonly tested according to ASTM C 157 standard.

Autogenous Volume Change

Autogenous volume change, commonly called "autogenous shrinkage", is a decrease in volume of the concrete due to the hydration of cementitious materials without the concrete effectively gaining or losing water. It is related to the material properties, especially the type of aggregates and the mix proportions.

Autogenous shrinkage therefore occurs over a much longer time period than drying shrinkage. Although no specific test method exists, autogenous shrinkage can be determined on sealed cylinder specimens with no load applied, in accordance with ASTM C 512 when required.

4.3.9 THERMAL PROPERTIES

Thermal properties for Conventional Mass Concrete and Roller-Compacted Concrete are generally similar. The influence of mix proportions on the thermal properties of RCC is primarily associated with the thermal properties of the aggregates and the total cementitious material content. Higher total cementitious material contents will increase the heat of hydration generated within the mass, resulting in thermal cracking when the RCC cools.

The American Concrete Institute (ACI) and some other studies show ranges of test values, including for the coefficient of thermal expansion, adiabatic temperature rise, specific heat and thermal diffusivity. These values can vary significantly depending on the types and contents of cement, aggregate, and pozzolan. One RCC cylinder is usually tested for the RCC's thermal properties at each age.

Figure 4.3.9.1, which is based on most of the existing USA RCC Dams, shows how the adiabatic temperature, at each age, increases as the cementitious content increases.

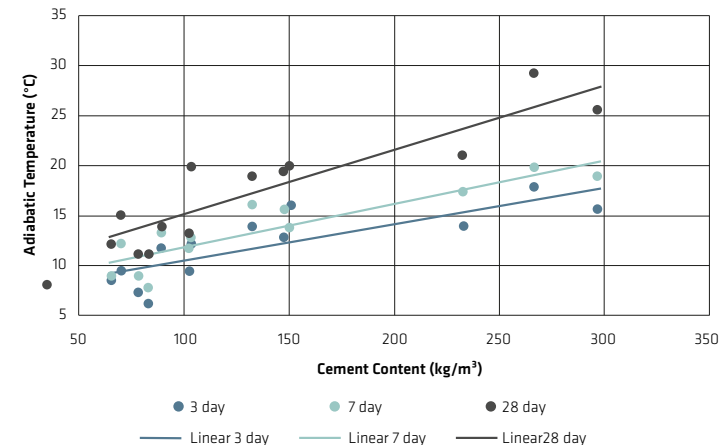

Figure 4.3.9.1: Adiabatic temperature rise of some RCC mixtures

5 CONSTRUCTION

5.1 GENERAL CONSIDERATIONS

The layout, planning and logistics required for the construction of RCC dams are different from those for traditional concrete dams. The quality of the production and placement of RCC is also directly related to the equipment and expertise of the contractor's construction personnel and to the project's RCC quality control and quality assurance measures.

One of the cost-saving features of RCC is the rapid rate at which it can be placed and consolidated. Typical production rates may range from 35 to 150 m³/hr for a small RCC project, 150 to 350 m³/hr for a moderate-size RCC project and 350 to 750 m³/hr for a large RCC structure. The production rate is the result of the concurrent, coordinated operation of several systems: aggregate production; materials batching and mixing; RCC transportation, placing, spreading and compacting; plus the quality control testing and other related operations. This faster placement means less time between the placement of lifts, resulting in lift joints with improved strength and seepage resistance.



Figure 5.1.1: A completed RCC dam in the south of Asia

5.2 AGGREGATES PRODUCTION

Segregation is the primary condition to avoid when handling aggregates. Unlike with conventional concretes, RCC aggregates are often grouped in non-traditional size ranges. This practice is intended to take advantage of the natural grading of some in situ materials in order to limit the processing of the aggregate that is required, also saving time and cost.

Some projects have used a single stockpile for the full aggregate grading, although this is not recommended. Small RCC projects will normally use commercial sources to avoid the significant development costs of a quarry site. Quarry site sources, however, may be much more attractive for larger projects to avoid long haul distances and higher costs from commercial sources. A plant location adjacent to the RCC structure also minimizes the transport time, which is critical to RCC quality, and again it reduces costs.

The specifications will normally require that a minimum volume of sand and coarse aggregate be available for use at the jobsite, prior to batching RCC. A steady flow of these materials is necessary for an optimum production facility and consistent RCC quality.

5.3 BATCHING AND MIXING

RCC batch plants include conventional batch plants and continuous feed plants. Conventional batch plants provide accurate, controlled delivery with recorded weights. These plants also provide some added flexibility for producing other concretes needed on the job. Continuous plants may be belt-scale feed plants or volumetric feed plants. Plants equipped with weight scales on the material's feed belts also provide some means of checking the concrete mix proportions during delivery.

The RCC concrete mixer should be designed and operated to ensure uniform distribution of materials throughout each mix. It must operate with little or no downtime and the maintenance and repairs must be scheduled with careful planning and then accomplished rapidly. Truck mixers are ineffective for discharging mixed RCC and so these are normally not considered or used for mixing and/or transporting RCC.

The RCC batching and mixing equipment should be sized with sufficient over-capacity that it is not the controlling feature of overall RCC construction progress. Slow RCC construction progress also tends to decrease the quality of the lift surface bonding and conversely also increases the time and cost of the plant clean-up activities.

The batch plant or batching system should generally have provisions in place for efficient heating or cooling of the RCC according to the seasonal program. RCC mix temperature requirements can frequently require the natural mix temperature to be reduced and equally commonly, and sometimes at different times on the same job, RCC mix cooling and additional techniques that include placing at night, limiting placement seasons, the use of pre-cooled aggregates, adding flake ice, and even liquid nitrogen can all be considered and used for temperature control to maintain the optimum production and construction schedules.



Figure 5.3.1: Production of Roller-Compacted Concrete



Figure 5.3.2: RCC discharged into a truck from the plant

5.4 TRANSPORTING AND DELIVERY

The selection of a suitable materials transport system is an integral part of the project, because the transportation of materials to the placement area can significantly influence the quality of RCC lift/layer surfaces. The two principal methods of transporting RCC are by conveyor and by haulage vehicles. Transport by buckets slows the rate of production and is more prone to cause segregation. In general, the best way to have a high-quality RCC layer surface is to use a transport system with conveyors and systems that combine conveyor and vehicle methods have also been effective on many projects.

The equipment used for transporting and delivering RCC should minimize segregation, should not reduce the workability or contaminate the lift surfaces and should be capable of delivering RCC to the placement location within 15 minutes of mixing. The maximum size of the aggregates and the tendency for the mixture to segregate are extremely important in selecting the best transportation method. Severe segregation can occur during RCC transportation with large NMSA and drier consistency mixtures, so design with wetter consistency mixes is recommended.

5.4.1 CONVEYORS

Transport by continuous high-speed conveyors has proven to be an efficient and safe way to transport RCC and conventional concrete from the concrete production plant directly to the placement area. Conveyor systems can be configured in several ways. In smaller projects, simple installations convey RCC from the plant to the placement site with just a few fixed conveyors. A rotating, retractable conveyor then deposits the RCC on the lift surface via a drop chute. Some larger projects have utilized a continuous conveyor on the upstream face of the dam that then discharges the RCC to a moveable conveyor capable of positioning with a drop chute at any desired location on the structure.



Figure 5.4.1.1: A conveyor system transports RCC from the top of a mountain to the dam site

Clogged materials transfer lines, segregation at the point of discharge, segregation over transport rollers, slow belts, not being able to stop or start a loaded belt quickly, excessive drying, loss of cement paste, and also the contamination of RCC lift surfaces by material dropping off the return sides of the belts, are probably the most common problems associated with conveyor transport systems.

5.4.2 VEHICLE TRANSPORTATION SYSTEMS

End-dump trucks usually haul RCC from the mixer, or from the distribution point, to the dam site. In this case a preliminary study should be made of the haul road system: if the concrete plant is located upstream of a dam, the method of bringing the road through or over the upstream face system must be worked out in detail. From a scheduling standpoint, the construction of any additional access roads should be completed prior to start of RCC placement.

Trucks and other vehicles, used to haul RCC from the plant to the lift surface, should not be allowed contaminate lift surfaces. Washing the haulage vehicle tyres frequently is generally required to prevent contamination of the lift surfaces, especially where a good bond to the next layer is required.



Figure 5.4.2.1: A truck unloads RCC at dam site



Figure 5.4.2.2: Workers wash a haul truck's tyres to prevent contamination of lift surfaces

5.4.3 COMBINATION TRANSPORT SYSTEMS

Many projects have used a combination system where the RCC is transported to the site using a conveyor and then transferred onto the specific location of the dam it is required by haulage vehicles. The use of this system has the advantage of some increased flexibility, plus the reduced need for haul roads to be built for the dam. Although this practice eliminates many contamination problems, surface damage to the RCC by the vehicles will still continue. In order to load trucks continuously, it is also advantageous to have some form of loading system at the end of the conveyor.

In all cases, these systems must include a hopper between the conveyor and the haul vehicles. The hopper allows continuous operation of the conveyor to be maintained when vehicles are not in position for loading. It also prevents scattering of RCC onto the lift surface under the conveyor, which can be a major source of segregation and surface contamination.



Figure 5.4.3.1: An example of combined system of transportation (conveyor and trucks)

5.5 PLACING AND SPREADING

RCC has been successfully placed in lift thicknesses of 150 mm to well over 1 m per layer, although RCC lift placements only rarely exceeded 600 mm. The lift thicknesses can vary depending on mix proportions, plant and transport capabilities, plus the project spreading and compacting procedures.

The dam/foundation interface is one of the most critical points of the structure. It is accepted general practice to create a platform with conventional concrete onto which the first RCC layer is placed. Then the edges of the dam are formed first by constructing concrete walls on the upstream and downstream faces of the dam.

Various sized dozers, generally having "U"-shaped blades, are the best for spreading RCC, because they contribute to uniformly compacting the RCC and to minimizing segregation. Workers are often required to remove and/or re-mix any segregated materials prior to compaction, which all takes more time and so is best avoided. If some segregation occurs during spreading work, the segregated aggregates are either removed or shoveled back on top of the spread surface prior to full compaction.

A dozer typically spreads the RCC in a 300 mm ± 50 mm thick, loose lift in a manner that allows the dozer to operate on uncompacted material. Dozers should operate on fresh RCC that has not been compacted, because operating the dozer on a compacted surface will potentially damage the RCC. When it is necessary for the dozer to drive onto compacted RCC, the operator should limit the movement to straight back and forth travel, or travel on rubber mats such as lengths of old conveyor belts.

It is recommended that RCC is transported, deposited, spread and compacted within 45 minutes after the mix water contacts the cementitious material, or as otherwise determined by the project specifications. This time range is closely related to variations in the environmental/atmospheric conditions and very specifically to the water evaporation rate from the mix (see Figure 2.4.3).



Figure 5.5.1: Placing and spreading operations

5.6 COMPACTION

Adequate compaction of RCC is important to obtain the required strength and density. There are a great variety of parameters that can influence the compaction phase, such as:

- The maximum size of aggregate
- The quantity and type of cementitious material
- The water content
- The thickness of the layers
- The equipment used.

It has been determined from various test sections and actual construction projects that RCC can be adequately compacted using a variety of vibratory steel-wheel compactors. Lifts may be compacted as individual layers, or several layers may be spread before compacting them as one lift prior to the initial set of the RCC (as in RCD dams).

The required number of roller passes must be verified during test section construction. Experience shows that four to eight roller passes are adequate to achieve desired densities for RCC lifts of 150 to 300 mm thickness. As a general rule, the compacted thickness of any RCC lift should be at least three times the diameter of the NMSA. Any excessive vibratory rolling can reduce the concrete density in the upper part of the lifts.

In addition to the desired compaction, a vibratory roller provides a tight, smooth lift surface that facilitates clean-up, prevents excess water penetration in wet weather, and reduces excessive evaporation and drying of the RCC in hot conditions. Compaction should be performed as soon as possible after the RCC is spread, especially in hot weather. Tests have shown substantial reduction in strength values if the RCC is compacted later than these limits, or when excessive mix temperatures occur. Cooler temperatures may allow extended time limits as with conventional concretes.

When RCC approaches full compaction, the concrete should exhibit slight plasticity as the roller passes over the RCC surface and cement paste should fill all the voids on the surface of the RCC when observed closely. If the surface of the RCC still remains stiff after additional roller passes, inadequate cement paste is present to fill all of the aggregate voids, and the consequent rock-to-rock contact will prevent further compaction. If any aggregates are crushed during compaction, it indicates a lack of workability in the RCC mix.



Figure 5.6.1: Compacting of RCC with a vibratory roller

5.7 JOINTS BETWEEN LAYERS OF RCC

The potential areas of weakness in a laminated RCC dam, from structural and impermeability point of view, are the joints between the construction lift layers. For a medium RCC dam of 500,000 m³, there will be somewhere around 1,500,000 m² of joint surfaces (expressed in another way this would correspond to a typical road carriageway of 230 km in length). If there is no segregation when the RCC is placed and spread, the RCC will perform as a monolithic concrete structure and with performance at least equal to that of a traditional concrete dam.

The bond between the layers of RCC is produced by two mechanisms: cementitious (chemical) bond, and penetration of the aggregates from the new layer into the surface of the previously placed layer (mechanical bond). As the open exposure time between placement of the layers increases, the chemical bond becomes the most prevalent factor, because the potential for mechanical penetration of the aggregates decreases faster than the chemical bond. The treatment of the joint surfaces between RCC layers differs from traditionally-placed mass concrete, because bleeding does not normally occur in RCC with a reasonable water/cementitious ratio. However, it is common for the full compaction / consolidation of RCC layers to bring paste to the surface, which if properly cured, does not have to be removed prior to placement of the next layer. In addition, the joint surfaces must be kept scrupulously clean.



Figure 5.7.1: Cleaning methods of layer surfaces

5.7.1 CLASSES OF JOINT AND NECESSARY TREATMENTS

There are several solutions that have been developed for improving the bond on to RCC layer surfaces. These relate to the time between compaction of a layer and placing of the next one. This approach defines three types of joints:

- A Fresh / Hot Joint: These are obtained when the next layer is spread and compacted before the previous one has reached its initial setting point. This method does not require any kind of treatment to the surface of the previously compacted layer, it is only necessary to keep it damp
- An Intermediate / Warm Joint: This is the surface condition that occurs between a fresh hot joint and a cold set joint. For lean RCC a bedding mix layer is required as pre-treatment before the next lift/layer of lean RCC
- A Cold / Set Joint: These occur when the previously laid RCC layer surface is no longer workable, resulting in little or no penetration of aggregates from the new layer of RCC into the previously compacted layer. Therefore a bedding mix pre-treatment is required for projects using lean, medium and high paste RCC

The Hot Joint approach is obviously the most economic and cost effective method, it is the fastest and so allows the highest rates of placing. However, during construction works there are always sometimes when the placing is interrupted and it is not possible to maintain a hot joint, for planned and unplanned reasons. In these situations the other two procedures (Intermediate / Warm and Cold / Set Joint) must be used, and therefore always prepared for on the site.

Immediately after the bedding mix has been applied and spread, the next layer of RCC must be placed, leveled and compacted. Cold joints can significantly increase the construction time and as they cannot be completely avoided, the necessary actions must be taken to minimise these in number and their total area.

5.7.2 BEDDING MIXES ON HARDENED RCC

Background Information. Bedding mixes, used to improve the bond on the surface of set RCC layers, are designed to improve the shear and tensile strengths of the joint for a given set of conditions. For low-cementitious and medium-cementitious RCC dams, the use of a bedding mix is an essential factor for producing acceptable joint properties. Normally, bedding mixes are always used in the following areas:

- Over the upstream face of each lift joint to ensure watertightness. When used for this purpose, the width of the application can range from several meters to one-third (1/4) of the width of the dam
- In dams where a higher bond strength between lifts is required (normally for dams built in earthquake zones where higher tensile and shear strengths are necessary across the lift-joints)
- In other areas such as massive foundations, dam facings and cofferdams (normally these structures require higher bond strength and watertightness to be assured between lifts)
- When a Cold Joint situation cannot be avoided



Figure 5.7.2.1: Laying and spreading of bedding mortar

There are two types of bedding mixes for RCC: bedding mortar and bedding concrete. They are placed progressively in a zone approximately 10 to 20 meters wide in front of the area where the RCC is being spread. Application of the bedding mix should normally only precede placement of the RCC by 10 to 15 minutes. The time between spreading the bedding mix mortar/concrete and placement of the RCC should be shortened during hot weather, and may be extended during cold weather. Bedding mix mortar/concrete is usually delivered to the placement area by concrete mixer trucks on projects where vehicle access onto the lift surface is possible and allowed, or more commonly it is delivered by cranes and buckets.

Normally the main criteria for selecting the bedding mix include heat generation and performances in terms of compressive strength and bond strength, as well as cost.

Table 5.7.2.1: Differences between bedding mortar and bedding concrete

Type of Bedding Mixes	Bedding Mortar	Bedding Concrete
Max. aggregate size	< 5 mm	> 5 mm
Thickness of bedding	~ 10 mm	up to 75 mm
RCC dams using bedding mixes, completed or under construction in 1996 (ICOLD, Bulletin 126)	77 %	23 %

Table 5.7.2.2: Principal characteristics of bedding mixes

Criteria	Bedding Mortar	Bedding Concrete
Thickness	Less difficult to compact the overlaying RCC as the thickness is ~ 10 mm	Difficulty in compacting the overlaying RCC due to the sideways "squeezing effect" of the more workable bedding concrete
Potential heat generation	Low heat generation	With a thicker bedding layer, more heat is generated
Shear strength	Slightly lower shear strength	Slightly higher shear strength
Cost	Lower cost	Higher cost

Mix Design Criteria/Considerations

Table 5.7.2.3: Requirements for mix design of bedding mix

Criteria	Requirements	
	According to PCA*	Based on a Sika reference project
Slump (mm)	150 - 230	At batching plant > 200 At discharge area 150 - 200 (average ≈ 175)
Maximum aggregate size (mm)	6.0 - 9.5	5 - 10
Minimum cement content (kg/m ³)	296	300
Maximum water-cement ratio	Not Stated	max. 0.95
Percentage of fine aggregates passing 75 micron (#200 sieve)	max. 3 %	max. 3 %
Admixtures	ASTM C494, Type D: water-reducing, retarding admixtures	ASTM C494, Type D: water-reducing, retarding admixtures
Design strength	min. 13.8 N/mm ² at 7 days, or min. 17.2 N/mm ² at 28 days	> 15 N/mm ² at 28 days The design strength of RCC was 15 N/mm ² at 365 days
Setting time	Retards initial set to > 3 hours	Not Stated. However, Sika® Plastiment® was used at 0.4 % by weight of binder. Initial setting time was > 90 minutes
Thickness	Not Stated	~ 25 mm (base on site observation)

*Portland Cement Association

Proposed Bedding Mix for a Sika RCC project in the South of Asia.

Table 5.7.2.4: An example of a mix design for bedding concrete

Material	Weight (kg/m ³)
Cement (Cem I)	220
Fly Ash	110
Fine Aggregate (0 - 5 mm)	1080
Coarse Aggregate (5 - 10 mm)	470
Water	250
Admixture (Sika® Plastiment®) 0.4 % by weight of binder	1.32
Slump	~ 200 mm
Air Content	3 - 5 %

5.8 CONTRACTION JOINTS AND CRACK CONTROL

The current practice for RCC design is to control temperature cracking with contraction joints. Contraction joints are installed using several methods. One method that has been used on several RCC construction projects is to create a crack or joint in the RCC by installing a galvanized steel sheet into the compacted RCC lifts at and along a predetermined joint location. This galvanized steel sheets act as a crack inducer. Other methods include the use of alternative bond breaker materials, such as plastic sheets.

5.9 FACING SYSTEMS FOR RCC

Large surface areas that are not horizontal, such as the upstream and downstream faces of dams can be specified as shaped to almost any desired slope or configuration. Methods that have been used to form these faces of RCC dams include the following:

- Facing with conventional concrete poured against formwork. This is the standard way of forming the upstream and downstream faces of RCC dams.
- RCC placed against formwork. The second most popular method, involves placing RCC directly against formwork. This method is becoming increasingly popular and an excellent finish can be obtained, provided that the RCC used for is sufficiently workable.
- Grout-Enriched RCC. The process for GERCC consists of first placing unconsolidated RCC adjacent to the upstream and downstream forms and then adding a grout mix that is vibrated into the RCC using immersion vibrators prior to RCC compaction.



Figure 5.9.1: GERCC placement phases

- Pre-cast conventional concrete panels. This method of forming a dam face is relatively expensive. Usually a membrane is also cast integrally on the inside of the pre-cast concrete panel to create an impermeable barrier, especially on upstream dam faces.
- Slip forming the facing elements. The use of an off-set paver to slip-form facing elements has the dual advantages of eliminating the need for formwork, and also separating the forming of the face from the placement of the RCC. This method is more used on large projects, where it becomes more cost effective and viable.
- Pre-cast concrete blocks. Pre-cast concrete blocks have been used especially for the downstream face (and in a few cases for the spillway) of RCC dams. This method is equivalent to the use of pre-cast concrete panels on the upstream face.
- Other methods. A significant number of other methods (such as the use of membranes) have also been used to form the faces of RCC dams, for more details refer to project specifications.

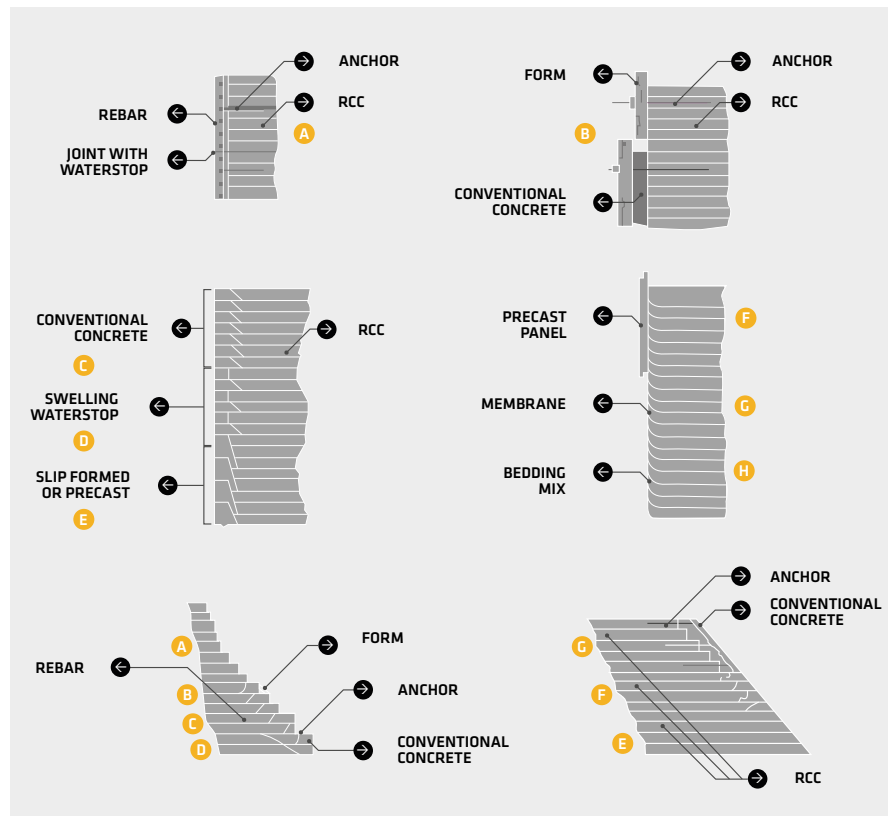

Figure 5.9.2: Upstream and downstream facing options (ACI)

5.10 GALLERIES AND WATERSTOPS

The location of the foundations and drainage galleries is important in the construction of a dam. The location of a gallery creates a significant amount of interference in RCC construction and can essentially cut off the upstream area from the downstream area. A gallery is often necessary to provide a location to drill drain holes and allow access for inspection.

Several methods have been used to construct galleries or other open spaces in RCC dams. Some methods have been developed to prevent interference with the RCC construction process, such as the use of sand fill or timber blocks, which are removed after the RCC has gained sufficient strength. Formed conventional concrete and formed RCC are also typical methods of constructing gallery walls within an RCC dam. Precast concrete panels or reinforced sprayed concrete have also been used for the roof of these galleries according to the location and performance requirements. Reinforced shotcrete, once it develops sufficient strength, is also used to support the construction loads.

The installation of waterstops and downstream joint drains typically requires the placement of conventional concrete. This is usually done in conjunction with placement of a conventional concrete upstream facing. Grout-enriched RCC is a practical and cost effective alternative to conventional concrete for encapsulating these waterstops and joint drains. Waterstops and joint drains are not usually included in structures with an impermeable membrane on the upstream face.



Figure 5.10.1: A gallery under construction at a RCC dam site

6 QUALITY CONTROL

6.1 GENERAL

The significant reduction in construction time that is an important advantage of RCC dams, makes quality control a very important factor in ensuring the final product quality. It is also important that quality control is considered not only during RCC placement, but throughout all the RCC construction phases.

The quality control program should also include continuous evaluations that can quickly resolve any issues with the necessary adjustments. When delivered to site, concrete is commonly tested before it is discharged in order to avoid the risk of having to remove non-conforming RCC, which would be very expensive. The extent of these continuous monitoring, inspection, evaluation and testing programs will depend on the type and size of the project.



Figure 6.1.1: A saddle dam under construction in Africa

6.2 ACTIVITIES PRIOR TO RCC PLACEMENT

As previously explained, RCC placing rates are significantly higher than for conventional concretes and with such rapid placement rates and shorter-term construction periods, any problems that delay the RCC placing, essentially all production on site. The most common placement delays are due to weather, equipment breakdown, insufficient materials availability, foundations preparation and clean-up of the RCC layer surfaces.

Firstly, it is extremely important that the quality control of the assembled RCC batching and mixing plant is of a high standard, including its manufacture and maintenance, to ensure continuous production of concrete (the requirements are the same with conventional concrete). Transport operations must be monitored to ensure acceptable RCC transit times are maintained, in order to avoid segregation and/or contamination during transit and to ensure proper RCC unloading and handling during placing and finishing operations. All of these factors can influence the RCC quality. Table 6.2.1 shows a summary of the most frequent initial QC requirements and issues on a typical RCC dam project.



Figure 6.2.1: Surface preparation prior to RCC placement

Table 6.2.1: Initial QC requirements and issues of a typical RCC dam project

Activities	
Preparatory Issues	<ul style="list-style-type: none"> ■ It is important that all plant operators understand the project requirements and procedures ■ Many RCC projects consist of nearly continuous placement operations and personnel numbers must be sufficient and not overworked ■ Appropriate equipment and testing facilities for the tests must be available prior to RCC placing operations ■ Technicians should be trained in the proper use of the equipment and in the proper testing procedures
Production Issues	<ul style="list-style-type: none"> ■ A sufficient quantity of aggregates, of acceptable grading and moisture content, should be tested and stockpiled prior to starting the RCC works ■ Monitoring the temperature within the aggregate stockpiles is very useful during RCC production ■ Sampling locations and equipment for cement, pozzolan, aggregates and RCC should be determined and included in the project specifications ■ Any operation, that may impact RCC placement, should be documented and discussed in detail
RCC Test Section	<ul style="list-style-type: none"> ■ A test section is used to demonstrate equipment and procedures to be used for the mixing, handling and placing of the RCC ■ It is normally made at least 2 or 3 weeks before the start of the main RCC placement ■ The test section is useful as training for both quality control and the site workers ■ The dam facing system should also be evaluated in the test section ■ The workability and density of the RCC mixture are evaluated by laboratory testing and any mix adjustments can be fine-tuned during the test section. This includes adjusting the water content and cementitious contents ■ It is useful to evaluate the RCC mix performance (segregation, mix proportions and compactability)
Determining field density/compaction requirements	<ul style="list-style-type: none"> ■ It is common to perform field density tests to establish or verify reasonable density requirements for the construction site RCC in comparison with the laboratory RCC mix properties used for design. The following steps illustrate a maximum density determination: <ul style="list-style-type: none"> - Select the location and dimensions of the control section - Begin compacting the freshly placed RCC and test - after every two passes until the density is no longer increasing, or the increase is less than 3.0 kg/m³ - Perform sufficient density tests to verify the maximum density and compare it with the project - specification requirements

6.3 ACTIVITIES DURING RCC PLACEMENT

Quality control during RCC placement involves two main operations: inspection and testing. Inspection is the first opportunity to observe any RCC problem or potential problem, and instigate corrective measures. Laboratory tests are explained in the earlier fourth chapter.

The primary goal of quality control during RCC placement is to identify problems before they occur, or sufficiently early in the process, so that they can quickly be corrected. Table 6.3.1 lists some of the most important items to check during RCC placement.

Table 6.3.1: Elements involved in quality control during RCC placement

Items	
Lift Surfaces	<ul style="list-style-type: none"> ■ RCC contact surfaces shall be free from ponding water, loose debris, mud or other detrimental material ■ Lift surfaces have been adequately cleaned prior to bedding mortar/RCC placement ■ Lift surfaces are maintained in a damp state at all times
Bedding Mortar/Concrete	<ul style="list-style-type: none"> ■ It is placed at the required thickness, correct consistency and that it is adequately spread ■ The RCC is deposited, spread and compacted only on fresh bedding mortar/concrete that has not begun to dry or set excessively
RCC	<ul style="list-style-type: none"> ■ The action of the dozers is controlled in a manner to eliminate voids and ensure proper compaction ■ Compaction of RCC occurs whilst the RCC is still fresh and has not lost the necessary workability ■ Visual inspection of the RCC mix should verify: <ul style="list-style-type: none"> - Adequate surface coating of the aggregates with cement paste or mortar - Any segregation problems - Any cracking of aggregate by roller action - Bleeding of the mix
Conventional Concrete	<ul style="list-style-type: none"> ■ It is deposited and consolidated in those areas where it is required, such as around waterstops and drains ■ The internal vibration at interfaces between RCC and conventional concrete must be in the right location and vibrated for sufficient duration

6.4 ACTIVITIES AFTER RCC PLACEMENT

Quality control after RCC placement should include periodic inspections to ensure that the concrete is being properly protected from possible damage. Records should be maintained which document the times of curing and action should be taken to correct problems when noted.

Inspectors should ensure that the RCC surfaces are protected from freezing, drying, or rainfall. When required, RCC surfaces should be covered with suitable insulating mats to reduce evaporation and/or protect the surface from adverse weather conditions. If rain is starting, inspectors should make sure that the site personnel complete compaction of any uncompacted RCC and then immediately cover the RCC surfaces to prevent damage.



Figure 6.4.1: An aggregates plant near a dam site in Vietnam

6.5 TRAINING

As a part of the quality control program, training sessions for all site supervisors, inspectors and workers are recommended. The differences in techniques between traditional and Roller-Compacted Concrete, should be discussed and understood by everyone.

Key issues should be explained, such as the time limitations for mixing, spreading and compacting, as well as the necessary concern about preventing segregation and curing times. Moreover, it should be emphasised that, although RCC can look and act like a soil when it is placed, spread and compacted, it is a concrete and should be treated with the same respect as traditionally-placed concrete.

Because the final properties of RCC depend very much on site quality control, it is strongly recommended that the site quality control and quality assurance operations are handled by people qualified and experienced in RCC technology.



Figure 6.5.1: A spillway included in the RCC dam body

6.6 TROUBLESHOOTING DURING RCC DAM CONSTRUCTION

Problems occurring in RCC dam construction are generally related to materials and construction practices; therefore adequate testing and evaluation of the results are necessary. Table 6.6.1 is an RCC troubleshooting summary, that includes the most commonly observed problems and issues, with the corresponding probable causes.

Table 6.6.1: Troubleshooting for RCC dam construction

Problem causes	Characteristic	Mixture consistency and setting					Segregation		Compactability/Density	
		Mix looks dry	Early setting of RCC	Mixture looks sticky	Fluctuations in workability	Excessive temperature rise	Mixture tends to segregate during handling, transportation, and unloading	Mixture tends to segregate during compacting	Required target density is not achieved	Honey-combed surfaces
Materials	Cement type		x	x						
	High cement content		x	x						
	Low Cement content						x			
	Quality/quantity of fine aggregates	x	x	x					x	
	Changes in gradation	x								x
	Changes in aggregate moisture content		x		x		x		x	x
	Mix contains excess water				x				x	
	Mix contains insufficient water	x		x						
	Chemical admixture overdosing or underdosing		x	x		x			x	
Storage, Batching and Mixing	Excess aggregate temperatures	x			x	x			x	
	Incomplete mixing	x		x	x		x		x	
	Plant is out of calibration						x		x	
	Load cells or moisture sensors are not functioning	x			x				x	
	Moisture losses are not accounted during batching				x					x
Transportation	Evaporation water loss	x			x		x	x	x	x
	RCC is transported without any covering	x			x					
	Extended lead time from mixing to placement	x	x			x			x	
	Dump trucks not washed periodically				x					
Compaction	Roller drums are not clean						x			x
	Vibration is applied too early							x		
	Variable compaction speed						x			
	Insufficient compaction load								x	
	Compaction is delayed								x	
	Mix is not ready for compaction							x	x	
Others	Poor quality of the bedding mix					x				x
	Delay in the application of bedding mortar		x			x				

7 SIKA REFERENCE PROJECTS

7.1 RCC DAMS AROUND THE WORLD

In the last twenty or so years, the use of Roller-Compacted Concrete has continued to gain recognition as a competitive material for building new dams and rehabilitating existing one. Many design details and construction methods have been adapted to enhance the final product, whilst maintaining the speed of construction that provides RCC its main competitive edge.

More than 750 large (a dam with a height of 15 meters or greater) RCC dams have now been built around the world using RCC and many others are now in design and under construction. Figure 7.1.1 below shows the consistent and rapid growth in the numbers of RCC dams that have been built from 1996 to date.

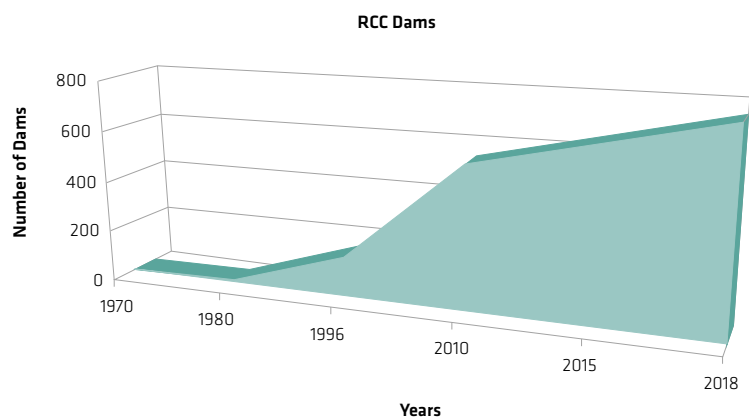

Figure 7.1.1: The growth in the number of RCC dams built over recent years

7.2 SIKA'S GLOBAL RCC DAMS REFERENCE LIST

For more than 50 years, Sika has been involved in many of the largest RCC dam construction projects around the globe. Sika now supplies RCC dam projects across all continents, with materials technology covering concrete and shotcrete admixtures, concrete fibres, as well as refurbishment and waterproofing solutions.

The following list covers only some of the major RCC dam projects that have benefited from the use of Sika technologies.

Project	Country	Year	Owner
Alpe Gera Dam	Italy	1964	Società Vizzola S.p.A.
Tarbela Dam	Pakistan	1975	Water and Power Development Authority (WAPDA)
Pak Mun Hydropower	Thailand River: Mun	1994	Electricity Generating Authority of Thailand (EGAT)
Zanja Honda Irrigation	Colombia	1998	NA
Joao Leite Water Supply	Brazil River: Joao Leite	2004	SANEAGO-Saneamento de Golas S.A.
Amata Irrigation	Mexico River: San Lorenzo	2005	Comisión Federal de Electricidad (CFE)
Nam Theun 2 HPP Hydropower	Laos River: Nam Theun	2007	Nam Theun Power Corporation (NTPC)/EdF (Electricité de France)
Dinh Binh Flood Control Hydropower Irrigation Water Supply	Vietnam River: Kon	2008	Ministry of Agriculture and Rural Development (MARD)
Picachos Irrigation Water Supply	Mexico River: Presidio	2009	Comisión Nacional del Agua (CNA)
Se San 4 Hydropower	Vietnam River: Poko	2009	Electricité de Vietnam (EVN)
Dong Nai 3 Flood Control Hydropower	Vietnam River: Dong Nai	2011	Electricité de Vietnam (EVN)
Dong Nai 4 Hydropower	Vietnam River: Dong Nai	2012	Electricité de Vietnam (EVN)

Project	Country	Year	Owner
Dak Mi 4 Hydropower	Vietnam River: Vu Gia	2012	Urban and Industrial Development Zone Investment Company (IDICO)
Son La Dam	Vietnam	2012	Vietnam Electricity
Palomino Hydropower	Dominican Republic River: Yaque del Sur and Blanco	2013	EGEHID (Empresa de Generacion Hidroelectrica Dominicana)
Huong Dien Hydropower	Vietnam River: Bo	2013	FPT Corporation
Dong Nai 2 Hydropower	Vietnam River: Dong Nai	2013	Trung Nam Power Jointsock Company
Nuoc Trong Irrigation Hydropower	Vietnam River: Tra Kluc	2013	Ministry of Agriculture and Rural Development (MARD)
San Vicente Dam Raise Water Supply	USA	2014	San Diego County Water Authority and City of San Diego
Ulu Jelai HPP/Susu Hydropower	Malaysia River: Bertam Telom and Lemoi	2016	Tenaga Nasional Berhad
Gibe III	Ethiopia	2016	Ethiopian Electric Power (EEP)
El Zapotillo Water Supply	Mexico River: Verde	2017	Comisión Nacional del Agua (CNA)
Nam Ngiep I Hydropower	Laos River: Nam Ngiep	2019	Nam Ngiep I Power Company
Xayabury Hydropower	Laos River: Lower Mekong	UC	CH. Karnchang Public Company
Nam Theun I Hydropower	Laos River: Nam Kading (aka Nam Theun)	UC	Nam Theun I Power Company
Grand Ethiopian Renaissance Dam Project (GERDP)	Ethiopia	UC	Ethiopian Electric Power (EEP)
Koysha	Ethiopia	UC	Ethiopian Electric Power (EEP)

UC = Under Construction

7.3 RCC DAM AND SIKA PRODUCTS

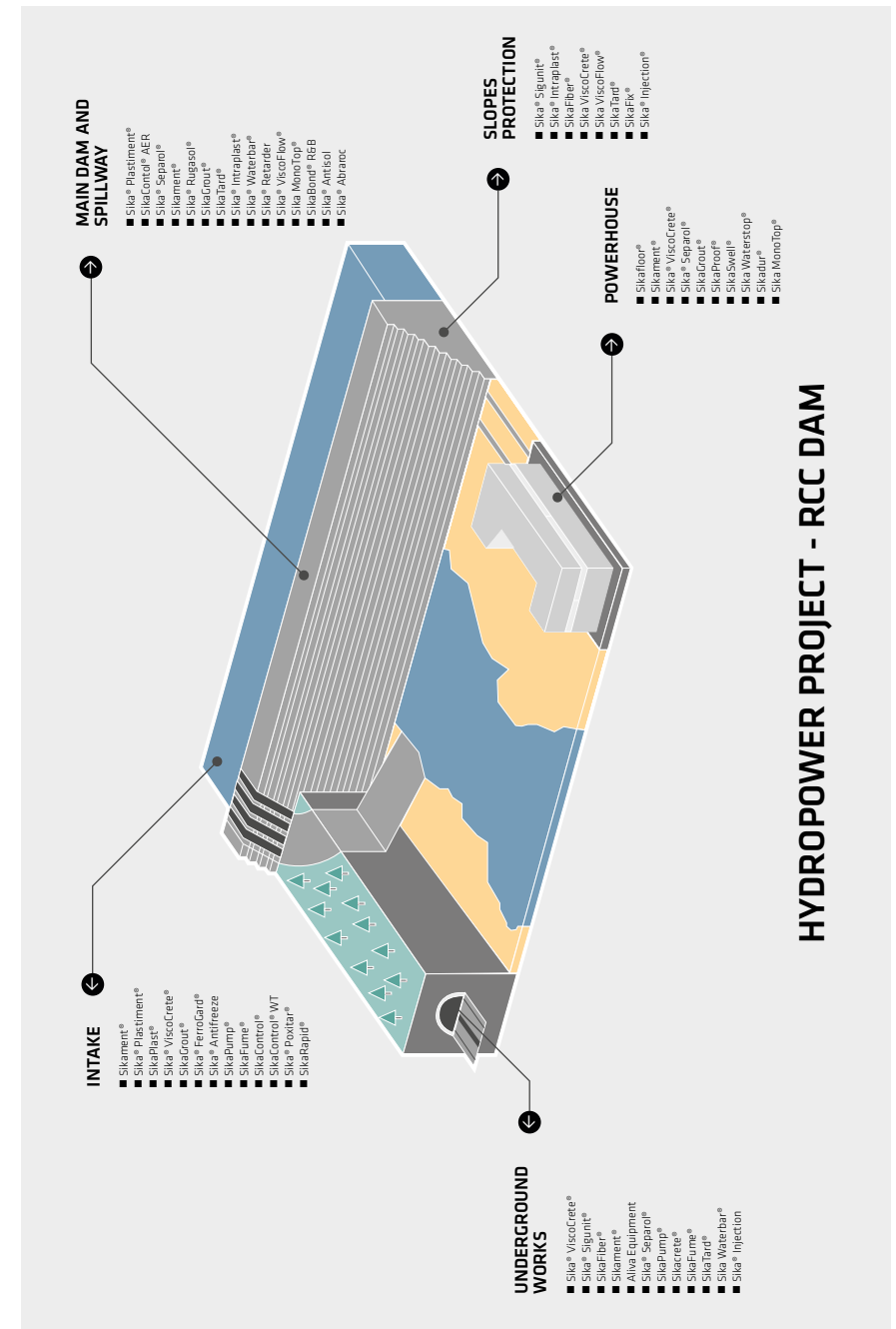

8 BIBLIOGRAPHY

The standards and quotes from the American Society for Testing and Materials (ASTM), the U.S. Army of Corps of Engineers (USACE), the U.S. Bureau of Reclamation (USBR), the American Concrete Institute (ACI) and other reference sources, that are applicable to Roller-Compacted Concrete materials, and so referred to in this handbook, are listed below:

ASTM Standards, 2018, *Annual Book of ASTM Standards*. West Conshohocken, Pennsylvania:

- C 33 – Specification for Concrete Aggregates
- C 94 – Specification for Ready-Mixed Concrete
- C 150 – Specification for Portland Cement
- C 172 – Practice for Sampling Freshly Mixed Concrete
- C 260 – Specification for Air-Entraining Admixtures for Concrete
- C 494 – Specification for Chemical Admixtures for Concrete
- C 512 – Test Method for Creep of Concrete in Compression
- C 618 – Specification for Fly Ash and Raw or Calcine Natural Pozzolans for Use as a Mineral Admixture in Portland Cement Concrete
- C 666 – Test Method for Resistance of Concrete to Rapid Freezing and Thawing
- C 684 – Test Method for Making, Accelerated Curing, and Testing Concrete Compression Test Specimens
- C1040 – Test Methods for Density of Unhardened and Hardened Concrete in Place by Nuclear Methods
- C 1078 – Test Method for Determining Cement Content of Freshly Mixed Concrete
- C 1079 – Testing Methods for Determining Water Content of Freshly Mixed Concrete
- C 1138 – Test Method for Abrasion Resistance of Concrete (Underwater Method)
- C 1170 – Test Methods for Determining Consistency and Density of Roller-Compacted Concrete Using a Vibrating Table
- C 1176 – Test Method for Casting No Slump Concrete in Cylinder Moulds Using Vibratory Table
- C 1557 – Test Methods for Moisture-Density Relations of Soils and Soil Aggregate Mixtures Using 10 lb (4.54 kg) Rammer and 18 in. (457 mm) Drop
- D 5982 – Test Method for Determining Cement Content Soil-Cement (Heat of Neutralization Method).

ACI, 2010, *Manual of Concrete Practice*. American Concrete Institute:

- 207.1R – Mass Concrete for Dams and Other Massive Structures
- 207.5R – Roller-Compacted Concrete
- 211.3R – Standard Practice for Selecting Proportions for No-Slump Concrete
- 304R – Guide for Measuring, Mixing, Transporting and Placing Concrete
- 304.4R – Placing Concrete with Belt Conveyors
- 325.1R – Roller-Compacted Concrete Pavements
- SP-2 – Manual of Concrete Inspection

Berga Luis et al., *Proceedings of the IV International Symposium on Roller-Compacted Concrete Dams*, Madrid, Spain, 17-19 November 2003 - 2 Volume.

Dunstan, M.R.H., 1978. *Rolled Concrete—With Particular Reference to Its Use as a Heaving Material in Concrete Dams*, The Concrete Society, London, March.

ICOLD, 2003. *Roller-Compacted Concrete Dams – State of the art and case histories*, Bulletin 126, Commission Internationale des Grands Barrages, Paris.

Isao Nagayama, Shigeharu Jikan, 2010. *30 Years' History of Roller-compacted Concrete Dams in Japan*, Public Works Research Institute.

Reclamation, 1987. *Guidelines for Designing and Constructing Roller-Compacted Concrete Dams*. Bureau of Reclamation, ACER Technical Memorandum No. 8.

Reclamation, 2017. *Design and Construction Considerations for Hydraulic Structures – Roller-Compacted Concrete (Second Edition)*. Bureau of Reclamation, Technical Service Center, Denver, Colorado.

USACE, 2000. *Roller-Compacted Concrete*. Engineer Manual No. EM 1110-2-2006, U.S. Army Corps of Engineers.

USACE, 1984. *Willow Creek Dam Concrete Report*. Vols. 1 and 2, U.S. Army Corps of Engineers, Walla Walla, Washington, October.

9 INDEX

A

Abrasion	62
Aggregate	16, 40, 65
Additives	14, 39
Additives content	12
Air voids	33
Air content	29, 48
Air-entraining admixtures	21
Admixtures	21, 27
ASTM	92
Accelerated curing	54
Autogenous shrinkage	63

B

Binder	76
Bleeding	72, 83
Bedding mix	74
Bedding concrete	75
Bedding mortar	29, 74

C

Cement	15
Cement content	39, 50
Cementitious	14
Cementitious content	30, 39
Concrete admixture	21
Concrete	8, 14, 30
Cohesion	13, 27
Compactability	11, 42
Compacting time	25
Compressive strength	30, 54
Cylinders	38, 51, 54
Construction methods	8, 35, 88
Coarse aggregate	17, 32
Cold joint	24, 73

Cores	54, 60
Conveyors	67

D

Density	30, 40
Degree of compaction	54, 62
Degree of consolidation	28
Drying	47, 71
Drying shrinkage	62
Direct tensile strength	57
Durability	8, 27
Design requirements	13, 28, 56
Dozers	7, 70
Downstream face	77

E

E-Modulus	61
Evaporation	70, 84
Embankment dams	8
End-dump trucks	68
Erosion	10, 62

F

Fines content	9, 21
Flexural strength	59
Fly ash	15
Formwork	77
Fresh concrete	8
Freeze-thaw resistance	62
Freeze-thaw cycles	27
Fine aggregate	17, 29
Fracture patterns	55
Facing system	77

G

Gravity dam	11, 13
Grout-enriched RCC	77, 79
Galleries	79

H

Hardened concrete	21, 24
Hardened RCC	59, 74
Hydration	14, 20
Hydration heat	15, 29
High-cementitious content	13, 29
Heat generation	10, 29, 75
Hot joint	24, 73

I

Impermeability	72
Initial setting	23, 73, 76
In-situ specimens	56

J

Joints	9, 57, 72
Joint spacing	12

L

Laboratory testing	15, 82
Low-cementitious content	13
Layer thickness	12
Lift/layer surfaces	67

M

Mass concrete	10, 23, 72
Mass concrete applications	7
Mechanical strengths	22, 26
Microwave oven testing	47
Mix design	28, 30
Mix water	20, 70
Minimum cement content	76
Minimum cost	31
Moulds	51
Mixing plant	81
Membranes	10, 78
Moisture content	11, 30, 36, 47

N

NMSA	18
Nuclear density gauge	46

P

Pavements	7, 36
Placement	8, 64
Placement time	15
Placing techniques	50
Plasticizer	21
Portland cement	15
Pozzolans	15
Penetration test	49
Poisson's ratio	38, 60

R

Roller-Compacted Concrete	8, 92
Rolled Concrete Dam	12
Retarding-plasticizer	21

S

Sand	17, 33, 65
Seepage resistance	64
Sample	52
Setting time	24, 49
Shrinkage	62
Slag cement	15
Surface contamination	69
Specimens	38, 52
Shotcrete	79
Strength development	11
Slump	8, 20
Slump test	29, 42
Segregation	18, 28, 38, 70, 81
Site conditions	11, 38
Seismic activity	13
Splitting tensile strength	58
Shear strength	38, 54, 74

T

Temperature	23, 50, 63, 77
Tensile strength	13, 24, 57
Testing machine	54, 58

Thermal properties	28, 63
Transport time	65
Test section	71, 82

U

Upstream face	67, 78
---------------	--------

V

Vibrating rollers	25
Vebe time	29, 42, 45
Vebe apparatus	43
Vebe testing	42
Vibrating hammer	53

W

Workability	10, 42, 71
Water-cement ratio	20, 29, 76
Warm joint	73
Waterstops	79, 83
Water content	33, 47
Watertightness	13, 29, 74

Y

Young's Modulus of Elasticity	60
-------------------------------	----

FOR MORE RCC DAMS INFORMATION



WE ARE SIKA

Sika is a specialty chemicals company with a leading position in the development and production of systems and products for bonding, sealing, damping, reinforcing and protecting in the building sector and the motor vehicle industry. Sika's product lines feature concrete admixtures, mortars, sealants and adhesives, structural strengthening systems, industrial flooring as well as roofing and waterproofing systems.

Our most current General Sales Conditions shall apply.
Please consult the most current local Product Data Sheet prior to any use.



SIKA SERVICES AG
Tüffenwies 16
CH-8048 Zürich
Switzerland

Contact
Phone +41 58 436 40 40
www.sika.com

BUILDING TRUST

