



ROOFING HANDBOOK Sarnafil® T

INFORMATION FOR THE PLANNING AND INSTALLATION OF
Sarnafil® T ROOF WATERPROOFING MEMBRANES

BUILDING TRUST



WORLDWIDE CONSTRUCTION AND INDUSTRY SOLUTIONS



Sika's history began in 1910 with the electrification of the Gotthard railway tunnels. The Swiss company founded by Kaspar Winkler played a decisive role in this momentous project. A revolutionary new waterproofing mortar was developed, marking the beginning of Sika's global reputation for high quality.

Today the Sika Group is a leading global manufacturer of construction chemical products and systems as well as industrial sealants and adhesives. The Group's core competencies – sealing, bonding, damping, reinforcing and protecting load-bearing structures – have been enabling a wide range of applications in the construction sector and in industrial production for over 100 years. The high-quality product range includes concrete admixtures, special mortars, sealants and adhesives, damping and reinforcing materials, floor coating systems, sealing membranes and corrosion protection products.

Sika annually produces a volume of roofing membrane that could cover the entire area of Manhattan. More than 10,000 roofing contractors in over 85 countries are Sika-trained and certified, which ensures qualified installation.

All our customers – developers, building owners, architects, engineers, consultants and contractors – receive expert advice from our highly competent team. Building on a foundation of trust, we offer our experience and knowledge to provide recommendations and long-lasting solutions for any project you may have.

Roofing can be selected and designed to meet the specific technical requirements and budget of almost any roofing project. Our tailored solutions allow freedom of design and form, with no limitations on geometry or color, to meet the specific requirements of any type of roof.

STRATEGIC SUCCESS THROUGH GLOBAL PRESENCE

- With subsidiaries in over 103 countries, Sika offers local presence worldwide
- Sika operates over 400 production sites and sales locations
- Sika employs approx. 33,000 people worldwide
- The Sika umbrella brand covers some 980 Sika product trademarks
- In fiscal year 2023 the Sika Group achieved sales of approximately CHF 11.24 billion

TABLE OF CONTENTS

SERVICE INFORMATION

Sika Sarnafil® – The Concept	8
Sika Technical Roofing Experts	9
Sika Roofing Application Technicians	10
Building Information Modeling (BIM) Objects	11
Wind Load Calculations	12
Computer Aided Design (CAD)	
Detail Drawings and Packages	13
Roof Drainage	14
Guarantees	15
Proven Performance – Durability of Sarnafil® T	16

PRODUCT INFORMATION

Sarnafil® T ROOF WATERPROOFING MEMBRANES

Material and Manufacturing	22
Inlays, Fleece- and Self Adhesive Film Backings	23
Roof Design	24
Color Chart	25
Product Overview	26
External Fire Performance Mechanically Fastened Roofs	28
External Fire Performance Adhered Roofs	30
Chemical Resistance	32
Product Properties	34

Sarnafil® T ACCESSORIES

Detailing Membrane	40
Metal Sheet / Coil	41
Welding Preparation / Cleaners	42
Solvent Free Cleaners	44
Adhesives, Primers and Sealants	46
Prefabricated Products	52
Roof Drainage	55
Ancillary Components	60
Walkways	64
Connection System	65
Fastening Products	67
Fastening Products – Induction Welding	72
Fastening Products – Combinations	74
Fastening Products – Tools	76
Roof Design Products	78
Product Overview Felts and Glass Fleece	80
Levelling- and Protection Layers	81
Separation-, Levelling- and Protection Layer	82
Separation- and Fire Protection Layer	83
Filter Layer	84
Protection- and Slip Layer	85
Protection Layers	86
Protection-, Drainage- and Filter Layers	87
System Overview SikaRoof® Control / Monitoring Systems	88
SikaRoof® Control / Monitoring	89
SikaRoof® Terrace Monitoring / Control	91
Compartments / Waterstop System	92
SikaRoof® Control – Leak Detection	93
SikaRoof® Control / Monitoring Products	94

SikaRoof® Control / Monitoring Systems	96
Technology Overview Thermal Insulations	98
Thermal Insulation Products	106
Product Overview Vapour- Control Layers / Barriers	108
Type of Application Vapour- Control Layers / Barriers	109
Vapour Control Layers	110
Vapour Barriers	111
Vapour- Control Layers / Barriers Accessories	114
Sika SolaRoof® System	116
SikaRoof® Anchor System	124
Application Tools	126

APPLICATION INSTRUCTIONS

Basics	132
Detailing with Sikalastic®-625 N	140
Sikalastic®-625 N Products	143
Fall Arrest System	146
Mechanically Fastened Roof System – Spot Fastening	148
Mechanically Fastened Roof System – Induction Welding	152
Mechanically Fastened Roof Systems – General	156
Gravel Ballasted Roof System	160
Inverted Roof System	164
Utility Roof System	168
Green Roof System	172
Adhered Roof System	176
Roof Refurbishment	181

STANDARD DETAILS

Overview	190
Layer Description	192
Parapet	194
Roof Edge Termination with Gutter	198
Upstand	202
Skylight	206
Roof Drain (Outlet)	210
Scupper	214
Overflow	218
Vent Pipe / Post	222
Gutter	226
Movement Joint	228
Penetration – Double T Steel Beam	232

SUSTAINABLE SOLUTIONS

Responsible for the Future – Sika Roofing Solutions	238
More Value Less Impact	239
The Sika Life Cycle Approach	240
The Sika Life Cycle Approach for Roofing Systems	241
Sika initiatives	242
Sustainability Performance Confirmed by EPD and LCA	246
Contributing to Green Building Certification Programs	247

Sika Sarnafil® – THE RIGHT CHOICE



Sika Roofing has been developing and producing high-quality polymeric waterproofing membranes and system solutions for new construction and renovation projects for over 55 years.

Whether building a giant shopping mall, an international airport, an efficient factory or an ecological residential building owners, architects, engineers and contractors can profit from decades of experience and know-how gained through thousands of installations worldwide.

With highly modern and environmentally responsible manufacturing processes, innovative development, and local service in over 100 countries, Sika Roofing delivers proven solutions that meet the highest standards of quality.

Sika Roofing solutions include both standard systems and individually tailored solutions that are designed to perfectly meet customers' needs. For customers this means **added value on the roof**.

Sarnafil® T

For decades, building owners, architects, engineers and contractors have valued the great design freedom and variety of solutions offered by the Sarnafil® T product line. These roofing solutions not only meet the highest requirements for appearance and design flexibility, they perfectly suit the trends of modern architecture and ecological construction.

The product line is supplemented by a comprehensive range of services to support customers in every stage of their projects.



Brochure:

Sarnafil® – Leading
the Way for 50 Years

SECURITY

A flat roof provides security when it is watertight and reliably protects the building. The consequences of a leaking roof become evident only when it is too late. The security of a flat roof is the result of an optimal combination of the right planning, material selection and installation.

Sika Sarnafil® IS THE RIGHT CHOICE FOR ROOF SECURITY

- Individual support in planning and selecting the best product system
- Over a billion installed square metres of flat roof experience

FIRE PROTECTION

Flat roofing systems that are flame sealed can easily initiate fire damage to buildings. The fire behaviour of the roofing system after installation is also important. And a further aspect to be considered is the built-in fire load.

Sika Sarnafil® IS THE RIGHT CHOICE FOR MINIMIZING FIRE RISK

- Hot-air welded seams, no open flame during installation
- Comprehensive testing for resistance to spreading flames and radiating heat, and thus classified as "hard roofing"
- Reduced fire load as a single-layer roof waterproofing system
- E-versions of Sarnafil® membranes provide elevated fire protection

SUSTAINABILITY

Sustainable construction is now an established trend. More and more private builders and public owners are requesting products and systems with proven environmental performance.

Sika Sarnafil® IS THE RIGHT CHOICE FOR SUSTAINABLE PERFORMANCE

- The option of sustainable construction certification through EPD / LEED
- No hazardous materials

Sika Sarnafil® – MORE THAN JUST A ROOF WATERPROOFING MEMBRANE



REFURBISHMENT

Damage repair is a necessity also for flat roofs. When it comes to preserving the value and substance of a building, replacement of an older roof often makes more sense in practical and economical terms than attending to constant repairs year after year.

Sika Sarnafil® IS THE RIGHT CHOICE FOR REFURBISHMENT PROJECTS

- Qualified advice from experienced engineers and technicians
- Comprehensive root-cause analysis of problems
- Building-specific refurbishment concepts
- The expertise of application technicians on site

ADDED VALUE

Flat roofs should not be considered “wasted space”. With good building design, roof surfaces can be made useable in a cost-effective way. Treating the roof as a design element requires systems with which design concepts can be easily realized.

Sika Sarnafil® IS THE RIGHT CHOICE FOR ADDING VALUE

- Comprehensive know-how and optimal coordination of the roofing system with any type of photovoltaic system
- Use of the roof surface as a terrace or roof garden
- Freedom in roof design – through colors, graphics, decor profiles, etc.

SERVICE

Today products are defined not only by material properties and test results but increasingly more by the services provided in connection with the product systems. Ideally, service does not end with delivery but accompanies you throughout the product lifecycle.

Sika Sarnafil® IS THE RIGHT CHOICE WHEN IT COMES TO SERVICE

- Individual support for all players involved in the construction project
- Qualified technical consultants who assist in project-specific detailed planning
- Application technicians on site
- A strong service team in the office and in the field

PARTNERSHIP

In addition to all these aspects, one concern is paramount to us: We want to be a reliable partner you can count on at all times. From consulting to execution to support throughout the service life of your building. For optimal collaboration amongst client, planner and applicator. With this vision in mind, we live up to our promise:



Sika Sarnafil® STANDS FOR RESPONSIBLE ROOF WATERPROOFING SOLUTIONS THAT PROVIDE LONGTERM VALUE AND PEACE OF MIND



SERVICE INFORMATION

TECHNICAL SUPPORT ALONG Sika Sarnafil® ROOF WATERPROOFING SYSTEMS	Sika Sarnafil® - THE CONCEPT	8	
	SIKA TECHNICAL ROOFING EXPERTS	9	
	SIKA ROOFING APPLICATION TECHNICIANS	10	
	BUILDING INFORMATION MODELING (BIM) OBJECTS	11	
	WIND LOAD CALCULATIONS	12	
	COMPUTER AIDED DESIGN (CAD) DETAIL DRAWINGS AND PACKAGES	13	
	ROOF DRAINAGE	14	
	GUARANTEES	15	
	PROVEN PERFORMANCE - DURABILITY OF Sarnafil® T	16	

Sika Sarnafil® – THE CONCEPT



Sika Sarnafil® MEANS MORE THAN HIGH-QUALITY WATERPROOFING MEMBRANE

The brand is built upon a whole philosophy – the Sika Sarnafil® concept. This concept links the tasks of the planners and applicators with our Sika Sarnafil® polymeric waterproofing membranes, coordinated system components, and our comprehensive and competent technical consulting for application. This begins in the planning phase and continues through implementation with intensive on-site service. The Sika Sarnafil® concept stands for optimal teamwork amongst planners, applicators and Sika – to ensure cost-effective, long-lasting and reliable roofing.

SECURITY THROUGH THE Sika Sarnafil® SYSTEM

- Service life expectancy of several decades
- Guarantee up to 20 years
- Comprehensive range of coordinated system accessories
- Field-tested installation systems
- Sustainable roofing systems (LCA data available)
- Over five decades of flat roof experience

SERVICES FOR PLANNERS

- Project-specific consulting by highly qualified technicians and engineers – Sika technical roofing experts
- Preparation of specifications / alternative concepts
- Calculation assistance
- Building physics calculations
- Preparation of individual refurbishment concepts
- Fastening plans for the roof
- Project monitoring and final inspection
- Support with documentation for building certifications such as EPD and LEED
- Installation monitoring

SERVICES FOR APPLICATORS

- Comprehensive advice from Sika technical roofing experts
- Individual site supervision by Sika roofing application technicians
- Complete product range from a single source
- Certified Sika Sarnafil® installation training

SIKA TECHNICAL ROOFING EXPERTS



SUPPORT FROM SIKA TECHNICAL ROOFING EXPERTS

- Object-related consulting for architects / planners, building owners and applicators
- Preparation of refurbishment concepts
- Preparation of building physics calculations
- Clarification of normative and constructive framework conditions
- Support in detailing design
- Providing various calculation tools
- Preparation of fastening layouts for roof areas



SIKA ROOFING APPLICATION TECHNICIANS



TRAINING COURSE OUTLINE

Our training courses teach the latest Sika Roofing technology. Thorough and continuing training of applicators is the best way to ensure first-class workmanship. Contact your sales organisation for information about our training courses.

Training course outline:

- Welding machines
- Welding procedures; welding seams
- Testing welded seams
- Perimeter securement

Detailing of:

- Inside and outside corners
- Vent pipe flashings
- Skylights



BUILDING INFORMATION MODELING (BIM) OBJECTS

BIM is a virtual design process, a construction process based on predefined products, these being full of information and includes all the different areas of execution of the work and subsequent maintenance improving collaboration between companies throughout the supply chain.

The BIM object is a 3D geometry which acts as a real product information database, which may comprise many different topics related to the product application and maintenance. It includes all the necessary information that allows to perform simulations of the final aspect.

BIM files are generated based on the existing product and system data sheets. In addition to this, specific data concerning the aspect of the materials and other thermal and physical properties may be included. BIM equips architecture, engineering, and construction professionals with the insight and tools to more efficiently plan, design, construct, and manage buildings and infrastructure.

BIM is described in many ways, but at heart it is a collaborative way of working, supported by software tools that make information about buildings available and analyzable.



WIND LOAD CALCULATIONS

Wind creates heavy uplift forces which can damage roofs. Wind loads at corners and perimeter can be two or three times higher than those in the inner area of flat roofs. When calculating uplift loads, characteristics of the building such as size, height, form, and type of construction must be considered, as prescribed by local standards.

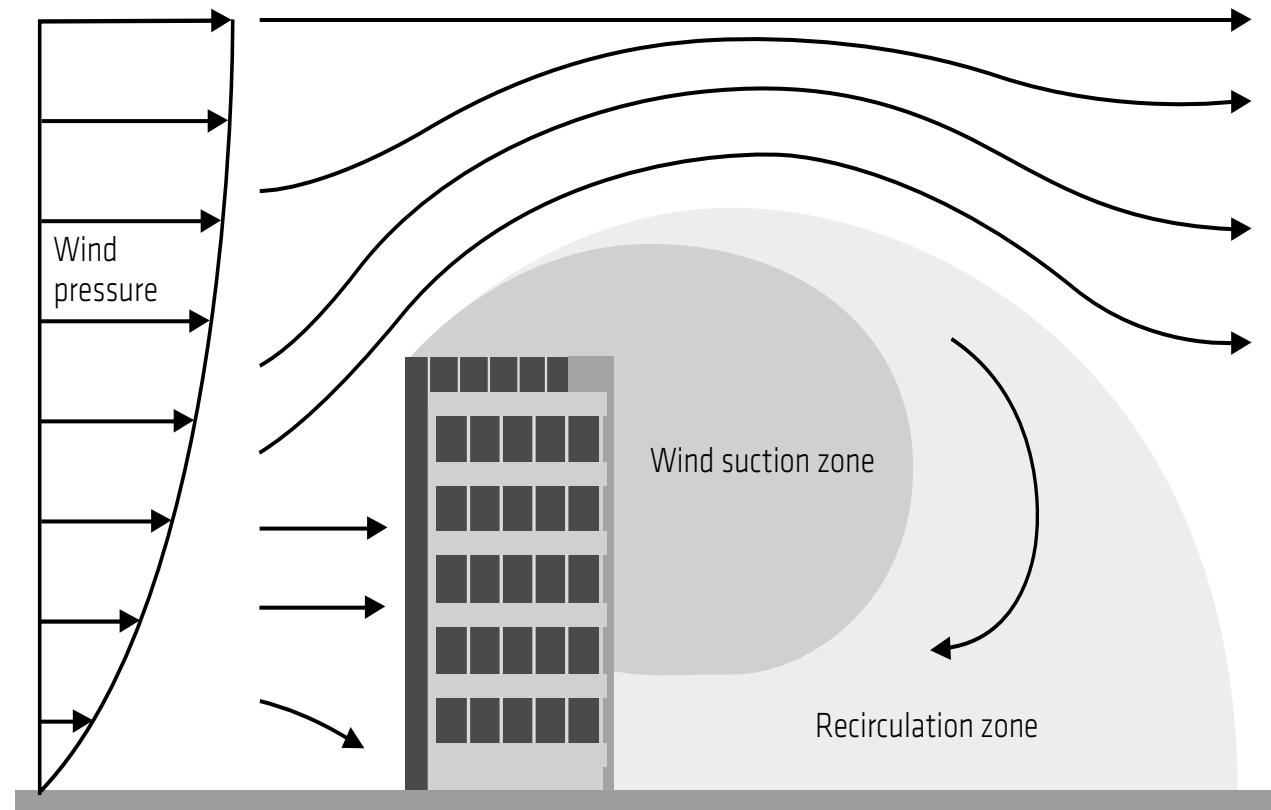

Sika offers a commercial, web-based software - RoofCalculator™ which is a versatile tool, used by the local Sika sales organizations to calculate mechanically fastened, adhered or ballasted roofing systems. The basis for performing roofing calculations is the normative standard EN 1991-1-4 - wind actions on building structures including country specific national annexes and Factory Mutual meeting FM datasheet 1-28 requirements. The customer receives a roof plan for optimized and efficient installation of the membranes and fasteners. The attached bill of quantities defines the numbers and types of fasteners to be used and the required quantity of membrane for the specific project.

THE MAIN FACTORS THAT INFLUENCE WIND LOADS ARE

- The building location (topography and surrounding environment)
- Building height
- Building shape and geometry
- Air permeability of the building shell (internal building pressure)
- Openings in the building (number and size)
- Design of the roof area (substructures and penetrations)



COMPUTER AIDED DESIGN (CAD) DETAIL DRAWINGS AND PACKAGES

Demanding specification selling requires customized and project specific detail drawings. Responsible Sika market organization is able to provide CAD detail drawings and packages for Sika Roofing.

The roof waterproofing layer of a specific Roofing System is blue indicated whilst all other products which can be offered by Sika are red indicated in the detail.

On each detail drawing, Membrane Technology, Roofing System, Type of Detail and Variant are mentioned. Beside that an individual numbering of the detail is also provided to make every detail unique!

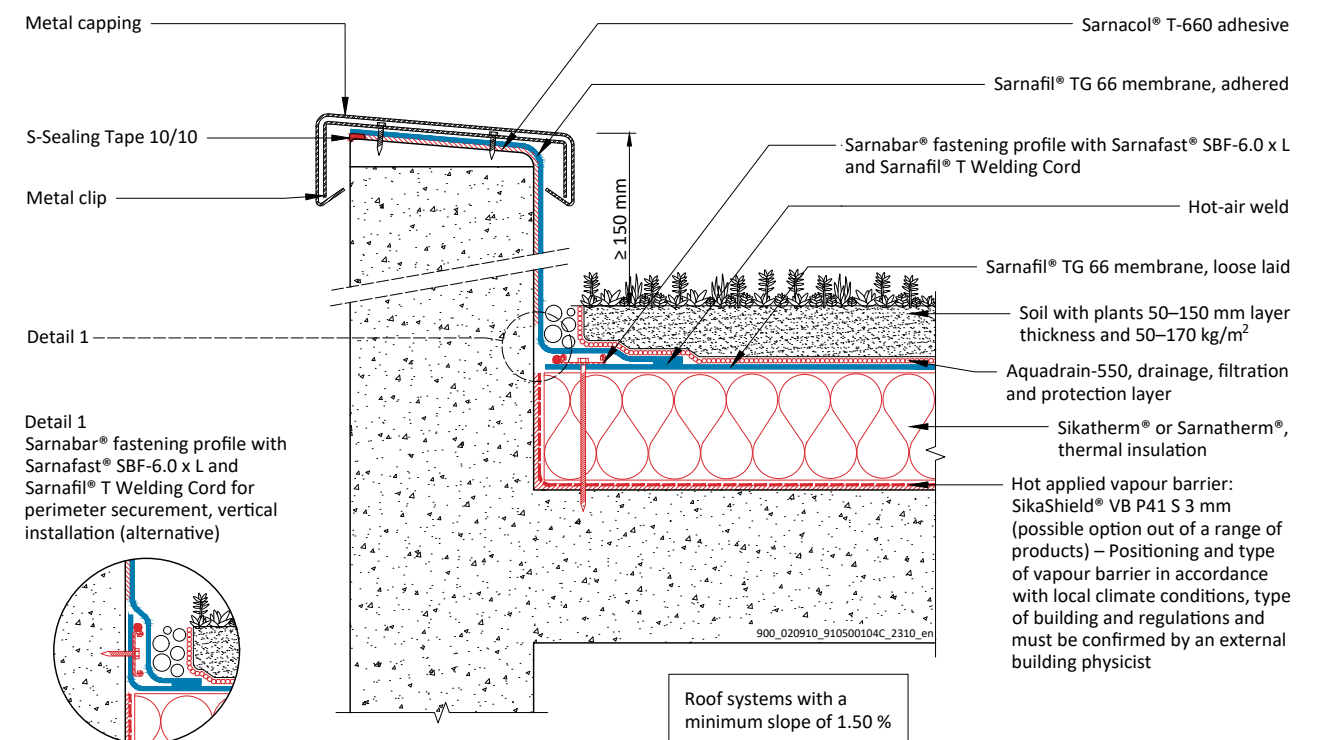

Sarnafil® FPO - GREEN ROOF SYSTEM - EXTENSIVE ON CONCRETE DECK WITH THERMAL INSULATION
 SF FPO - 050.01.04 - parapet - metal capping - adhered on concrete parapet
 Sika General Detail. Project: Roofing handbook

900_020910_910500104C_2303_en
 March 2023

DRAWING MUST ALWAYS BE REVIEWED BY A DESIGN SPECIALIST AND IF NECESSARY MODIFIED TO ENSURE SUITABILITY FOR THE SPECIFIC APPLICATION
 The information contained herein and any other advice are given in good faith based on Sika's current knowledge and experience of the products when properly stored, handled and applied under normal conditions in accordance with Sika's recommendations. The information only applies to the application(s) and product(s) expressly referred to herein and is based on laboratory tests which do not replace practical tests. In case of changes in the parameters of the application, such as changes in substrates etc., or in case of a different application, consult Sika's Technical Service prior to using Sika products. The information contained herein does not relieve the user of the products from testing them for the intended application and purpose. All orders are accepted subject to our current terms of sale and delivery. Users must always refer to the most recent issue of the local Product Data Sheet for the product concerned, copies of which will be supplied on request.

ROOF DRAINAGE

DRAINAGE OF FLAT ROOFS

The drainage of flat roofs is essential to drain off rain water and to protect the roof against moisture damage and warping. Sika products are available for flat roofs of solid or lightweight construction. These days, the most common roof structure is the single-ply, non-ventilated flat roof (warm roof). This can also be converted to an inverted roof. Unlike a conventional non-ventilated flat roof, in a inverted roof construction the waterproofing is located beneath the thermal insulation. Technical details of the drainage solutions will always need to be tailored to the particular features of the building. Generally speaking, when dealing with flat roofs, a distinction is made between non-utilised surfaces, i.e foot traffic only occurs for the purpose of maintenance, and utilised flat roofs, which can withstand the weight and impact of pedestrian and/or vehicle traffic.

DESIGN CONSIDERATION

In the case of flat roofs, drainage is carried out at roof low points; each low point of a roof surface is drained via a roof drain and an overflow drain. Drainpipes must be thermally insulated if the rooms below are heated as they represent thermal bridges in the roof structure. Heated drains prevent icing in freezing temperatures, particularly if the rooms below are not heated.

Roof drains must be positioned so that their flange outer edge is at least 30 cm away from the outer edges of other installations on the roof, joints or other ducts penetrating the roof membrane. Roof drains are delivered with connecting flanges that are welded to the roof waterproofing membranes.

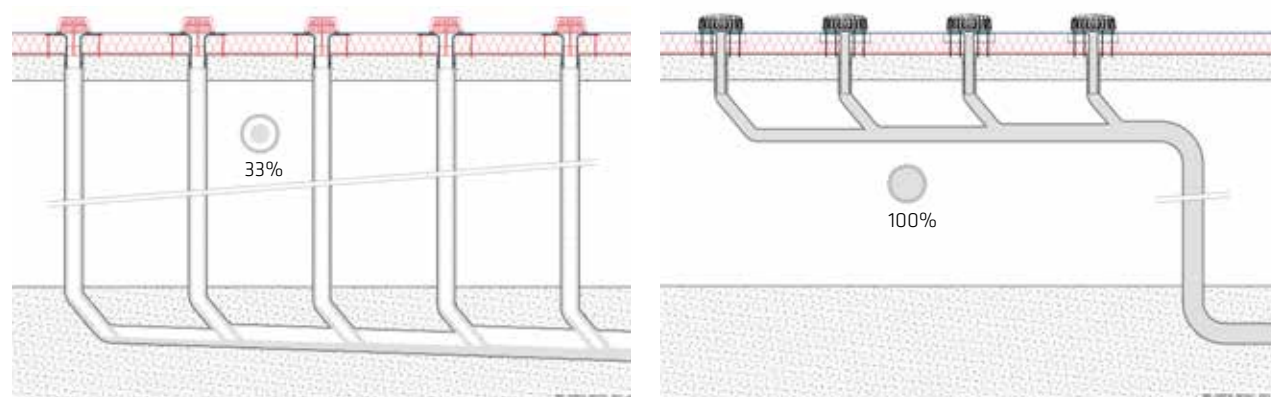

Gravity drainage system with partially (33%) filled rain water pipes.

Siphonic drainage system with fully (100%) filled rain water pipes.

GRAVITY DRAINAGE

With gravity drainage, the water is drained over several downpipes into a drainage pipe laid in the slope where it is drained away from the roof. Drainage of the rainwater occurs according to the physical law of gravity. The drainage rate is primarily influenced by the slope of the outlet pipe and the structure of the roof drain. The pipe system for gravity drainage should always be partially filled with water.

SIPHONIC DRAINAGE

In the case of siphonic drainage, the outlet flows of the individual drains are transported to a common downpipe via connecting pipes underneath the roof structure. Drainage of the rainwater creates a negative pressure in the collecting main, which ensures the quick and effective drainage of the roof area at a high flow rate. Because the pressure pipe system is operated fully-filled according to the physical law of negative pressure, the pipes running underneath the roof can be laid without a slope, enabling spaces to be used more effectively.

OVERFLOW DRAINAGE

The controlled functionality of the rain drainage system, both in the partial load range and in the event of an overload, e.g. in the case of once-in-a-century rainfall levels, must be ensured at all times. For such events, the standard stipulates the need for an overflow drainage system in the form of an overflow drain. Furthermore, the overflow drainage system must be connected to a dedicated outflow from which the water can drain freely onto floodable land – it must not be connected to the normal drainage system.

GUARANTEES

Performance over time is the ultimate demonstration of the quality of a roofing system. We have been successfully developing, producing and installing Sika Roofing Systems for over 50 years. An investment in a Sika Roofing System is an investment in a proven technology and performance – proven by thousands of watertight roofs around the world.

GUARANTEE TYPE

Sika roofing membranes are produced using controlled high-quality raw materials. The membranes are subject to many stages and forms of quality control during and after manufacturing. Sika thus offers a guarantee for Sika Sarnafil® product line. This guarantee covers:

- Watertightness of Sika Sarnafil® membrane and its accessories
- Products delivered by Sika are compatible with these membranes and fulfill their respective functions within the roof build-up

Guarantee will be issued individually for each project by the local Sika Organization, in conformance with local laws. The guarantee can be issued as requested either to the applicator or the owner.

BUILDING TRUST

ROOFING SYSTEM GUARANTEE

15 YEARS

APPLICATOR – [Name of Company]

Guarantee No.:	
Building with address:	
Size of roof area: Size in m ² :	
Guarantee Period:	15 years from the date of issuance
Applicator:	
Sika [Name of Company]:	
Date / Place:	
Delivered membranes:	
Other Sika Products delivered ¹ :	
Delivery Date:	

1. Sika [Name of Company] ("Sika") warrants to the Applicator that the membranes listed above and supplied by it fulfill their waterproofing function. All other Sika Products delivered by Sika are compatible with the membranes and fulfill their respective function within the roof build-up.
2. Should the Applicator during the Guarantee Period give written notice of any defect for which Sika is responsible pursuant to clause 1 of this Guarantee, Sika shall rectify such defect at its own expense as well as any property damage resulting from water ingress, to the extent caused by such defect. The scope and extent of the remedial work is in the sole discretion of Sika and such remedial work is the sole remedy of the Applicator under this Guarantee.

¹ Membranes and other Sika Products jointly referred to as "Sika Products"

PROVEN PERFORMANCE – DURABILITY OF Sarnafil® T

Sarnafil® T membranes have been in use now for 30 years. During this period of time, several investigation and expert reports were published.

The latest investigation and expert report dated from December 2014 which concerns the durability of polymeric roofing membrane types Sarnafil® TS 77 and Sarnafil® TG 66 (based on a study of five 17 to 25 years old roofs, plus 158 additional roofs that were investigated and assessed by Sika personnel in a field survey, and also including Sika's internal production monitoring data and test results).

The roof assessment and testing has been conducted independently of the Sika surveys and testing, according to following criteria:

- Roof assessment: General condition of the roof, roof build-up / assembly, flashings, welded seams, structural aspects.
- Material samples: Thickness, tensile strength, elongation at break, low temperature foldability, peel strength and shear strength of site-welded seams, including the seams of new membranes welded onto existing exposed membranes, together with microscopic investigation of the membrane surface. These properties are those regarded as essential for predicting the durability of polymeric waterproofing membranes.



Brochure:
Durability of Sarnafil® T
Polymeric Roofing
Membrane



The results of this long term study and the 25 years of proven, positive experience for the durability of Sarnafil® T suggests that given ensuring the standard roof conditions and use in compliance with the products application and maintenance requirements, the polymeric roofing membranes Sarnafil® T will continue to fulfil their waterproofing function for many more years.

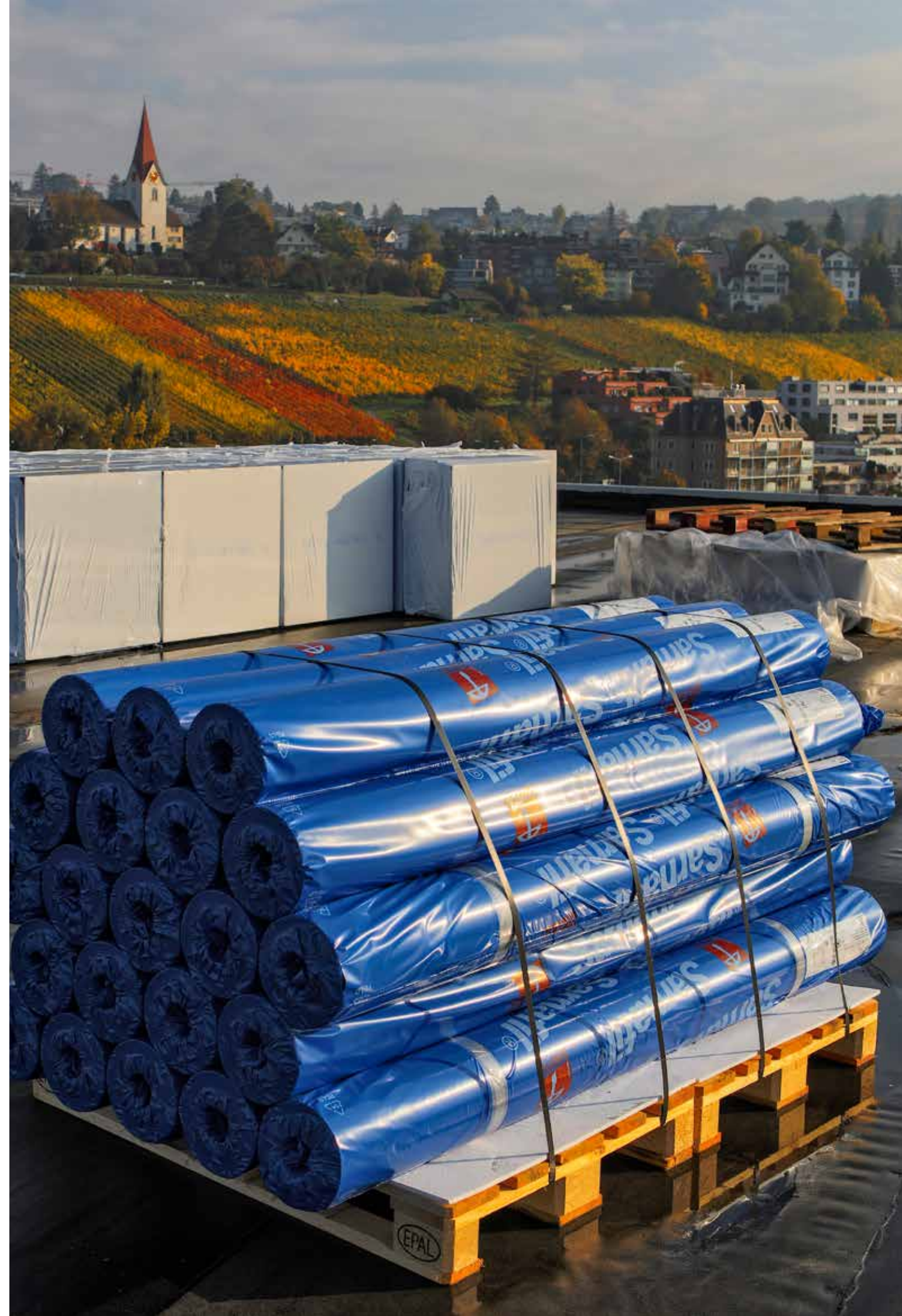



PRODUCT INFORMATION

Sarnafil® T ROOF WATERPROOFING MEMBRANES
AND CORRESPONDING SYSTEM ACCESSORIES

SERVICE INFORMATION

PRODUCT INFORMATION

APPLICATION INSTRUCTIONS

STANDARD DETAILS

SUSTAINABLE SOLUTIONS

PRODUCT OVERVIEW

Sarnafil® T ROOF WATERPROOFING MEMBRANES

Material and Manufacturing 22

Inlays, Fleece- and Self Adhesive Film Backings 23

Roof Design

- Decor Profiles 24
 - Sikagard® Graphics 24
 - Sika Sarnafil® Colors 24

Color Chart 25

Product Overview 26

External Fire Performance

- Mechanically Fastened Roofs 28
 - Adhered Roofs 30

Chemical Resistance 32

Product Properties

- Sarnafil® TG 66 34
 - Sarnafil® TG 76 Felt PS 35
 - Sarnafil® TG 76 E Felt PS 36
 - Sarnafil® TG 76 FSA 37
 - Sarnafil® TS 77 38
 - Sarnafil® TS 77 E 39

Sarnafil® T ACCESSORIES

Detailing Membrane

- Sarnafil® T 66-15 D 40

Metal Sheet / Coil

- Sarnafil® T Metal Sheet / Coil 41

Welding Preparation / Cleaners

- Sarnafil® T Prep 42
 - Sarnafil® Wet Task-Set 42
 - Sarnafil® Seam Preparation Cloths 43
 - Sarnafil® T Clean 43
 - Solvent T-660 43

Solvent Free Cleaners

- SikaRoof® Clean Set Detail 44
 - SikaRoof® Clean Pad Detail 44
 - SikaRoof® Clean Agent 44
 - SikaRoof® Clean Set Area 45
 - SikaRoof® Clean Pad Area 45

Adhesives, Primers and Sealants

- Sarnacol® T-660 46
 - Sarnacol®-2142 S / -2142 V 46
 - Sarnacol®-2116 46
 - SikaRoof® Tape P 47
 - SikaRoof® Multitape 47
 - SikaRoof® Board Adhesive 47
 - Sika® Primer-3 N 48
 - Primer-780 48
 - S-Sealing Tape 10/10 48
 - Sika® Aktivator-205 49

- Sikaflex®-11 FC Purform® 50
 - Sarnaplast®-2235 50
 - SikaBond® TF plus N 50
 - Released / Approved Applications for Sealants 51

Prefabricated Products

- Sarnafil® T Preformed Components CI / WA 52
 - Sarnafil® T Corner 90° I / A 52
 - Sarnafil® T Pipe Flashing 52
 - Sarnafil® T Post Flashing 53
 - Sarnafil® T Point Flashing 53
 - Sarnafil® T Lightning Conductor Flashing 53
 - Sarnafil® T Lightning Conductor Circus 54
 - S-Lightning Conductor Clip 54
 - S-Lightning Conductor Clip V2A 54

Roof Drainage

- Sarnafil® T Gully Set 55
 - Sarnafil® T Gully Horizontal / Vertically 55
 - Sarnafil® T Drain 56
 - S-Gully Overflow screw-on device 56
 - Sarnafil® T Overflow - round 56
 - Sarnafil® T Overflow - square 57
 - Sarnafil® T Scupper - round 57
 - Sarnafil® T Scupper - square 57
 - SikaRoof® Drain Inspection chamber 58
 - S-Leafguard round 58
 - S-Duoseal Couplings 58
 - Gravel Frame with adjustable put on frame 59
 - Perforated strainer 59

Ancillary Components

- S-Gravelstop Profile 60
 - Sarnafil® T Gravelstop bracket 60
 - SikaRoof® Cable Duct-110 61
 - Paving support Pad / levelling shim 61
 - Snow guard holder galvanized 62
 - Snow guard stainless steel 62

Walkways

- Sarnafil® T Walkway Pad 64
 - Sarnafil® TG-20 WW 64

Connection System

- Sarnafil® T Dilatec® ER-300 65
 - Sikadur Combiflex® CF Adhesive Normal / Rapid 65

Fastening Products

- Sarnafast® Washer KTL 67
 - Sarnafast® Washer KT 67
 - Sarnafast® Washer IF/IG-C 67
 - Sarnafast® Tube SFT-50 68
 - Sarnafast® Insulation Washer DTL 68
 - Sarnafast® Insulation Washer DT 68
 - Sarnabar® Fastening Profiles 69
 - Sarnabar® Tube SBT-20 69
 - Universal Row / Load Distribution Plate 69
 - Sarnabar® Connection Clip 70
 - Sarnafil® T Welding Cord 70
 - Sarnafast® Fastener SBF-6.0 71
 - Sarnafast® Fastener SF-4.8 71
 - Sarnafast® Fastener SF-M 4.8 71

Fastening Products - Induction Welding

- SikaRoof® Induction Welding Disc FPO 6.8 72
 - SikaRoof® Induction Welding Disc FPO 16.0 72
 - SikaRoof® Induction Cardboard Pad 72
 - Isoweld® 3000 73
 - Hand inductor FI-H 73
 - Magnets FI-Magnet 73

Fastening Products - Combinations 74

Fastening Products - Tools 76

Roof Design Products

- Sarnafil® T Decor Profile 78
 - Sikagard®-950 78
 - Sikalastic® Primer FPO 78

Product Overview Felts and Glass Fleece 80

Levelling- and Protection Layers

- S-Felt A-300 81
 - Sikaplan® W Felt 500 PP 81
 - S-Felt S-800 81

Separation-, Levelling- and Protection Layer

- S-Felt T-300 82

Separation- and Fire Protection Layer

- S-Glass Fleece-120 83

Filter Layer

- S-Felt VS-140 84

Protection- and Slip Layer

- S-Felt GK-400 85

Protection Layers

- Sarnafil® TG 63 86
 - S-Protection Sheet RS 86

Protection-, Drainage- and Filter Layers

- Aquadrain 550 87
 - SikaRoof® Drainage Layer 20L2F 87

System Overview SikaRoof® Control / Monitoring Systems 88

SikaRoof® Control / Monitoring

- Control Pipe - Manual Visual Inspection Possibility 89
 - Control Pipe - With Integrated 24/7 Monitoring 89
 - Control Pipe - With Integrated Leak Detection Possibility 90
 - Control Pipe - With Integrated 24/7 Monitoring and Leak Detection Possibility 90

SikaRoof® Terrace Monitoring / Control

- Roof Terrace - With Integrated 24/7 Monitoring 91
 - Roof Terrace - With Integrated 24/7 Monitoring and Leak Detection Possibility 91

Compartments / Waterstop System 92

SikaRoof® Control - Leak Detection 93

SikaRoof® Control / Monitoring Products

- Sarnafil® T Sensor Control Pipe Set 94
 - SikaRoof® Sensor Active R / T 94
 - Sarnafil® T Drain 94
 - SikaRoof® XPS insulation core and Lid 94
 - Sarnafil® T Control Pipe Set 95
 - SikaRoof® Glass - Graphite Fleece 95
 - SikaRoof® Stainless Steel Mesh 95
 - SikaRoof® Control Contact Plate 95

SikaRoof® Control / Monitoring Systems

- SikaRoof® Sensor Data Transmission 96
 - Terrace Control / Monitoring System 96
 - Standard Control / Monitoring System 97

Technology Overview Thermal Insulations 98

Thermal Insulation Products

- Sikatherm® PIR GT 106
 - Sikatherm® PIR AL 106
 - Sikatherm® EPS 106
 - Sikatherm® XPS 106

Product Overview Vapour- Control Layers / Barriers 108

Type of Application Vapour- Control Layers / Barriers 109

Vapour Control Layers

- Sarnavap®-1000 E 110
 - Sarnavap®-2000 E 110

Vapour Barriers

- Sarnavap®-5000 E SA FR 111
 - Sarnavap®-5000 E SA 111
 - Sikavap-5000 E SK AL 112
 - SikaShield® VB E71 PE SA 3 kg/m² 113
 - SikaShield® VB P21 T 3 mm 113

Vapour- Control Layers / Barriers Accessories

- Sarnavap® Tape F 114
 - Sarnatape®-20 114
 - Primer-130 114
 - Primer-600 115
 - Sika® Igoflex® P-01 / P-10 115

Sika SolaRoof® System 116

SikaRoof® Anchor System 124

Application Tools

- Varimat V2 126
 - Leister Triac AT / ST 126
 - Spare Parts for Leister Hand Welding Tool 127
 - Sarnafil® Gas Heating Gun 128
 - Spray Application Gun 128
 - Fitting Tool for Sarnabar® 128
 - Sika Membrane slitter 128

MATERIAL AND MANUFACTURING



PRODUCTION PROCESS

Sarnafil® T is a polymeric alloy made of a blend of premium-quality flexible poly-olefins. Sarnafil® T membrane is manufactured in a patented process in which the reinforcement or support layer is extrusion-coated to produce a membrane without internal tension.

Sarnafil® T membrane is carefully produced on specially designed machines. In extruders, the synthetic components and additives are melted, mixed and then uniformly coated onto both sides of the reinforcement mesh or support layer.

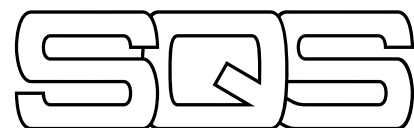
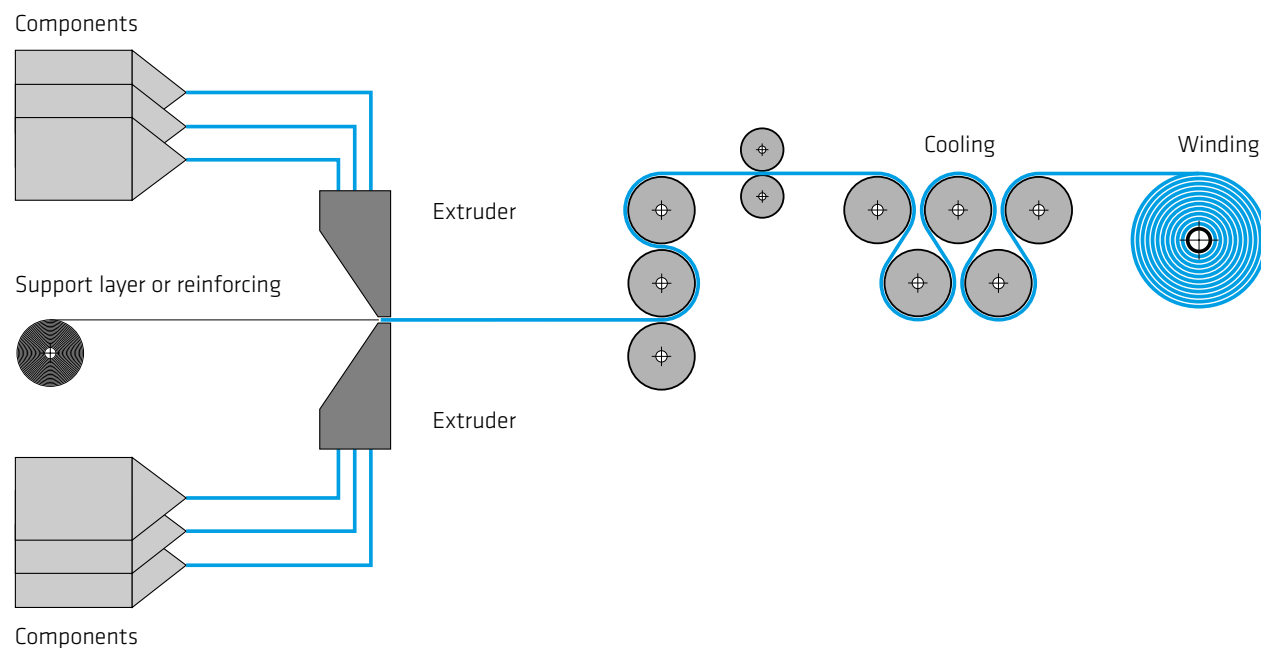

QUALITY MANAGEMENT

Sika roof waterproofing membranes are under permanent quality monitoring during manufacturing process. The monitoring also includes the controlling of incoming admixtures and materials during all stages of production up to the testing of produced membranes until shipped to the project site, complete recorded by ISO-9001 quality management, ISO 14001 environmental management and OHSAS 18001 occupational health and safety management system certification.

Beside the internal testing of our Sika roof waterproofing membranes, external quality control is provided by independent and governmental material test institutes.

Based on this reasons and our experience for decades, Sika provides waterproofing systems on highest technical level.

INLAYS, FLEECE- AND SELF ADHESIVE FILM BACKINGS

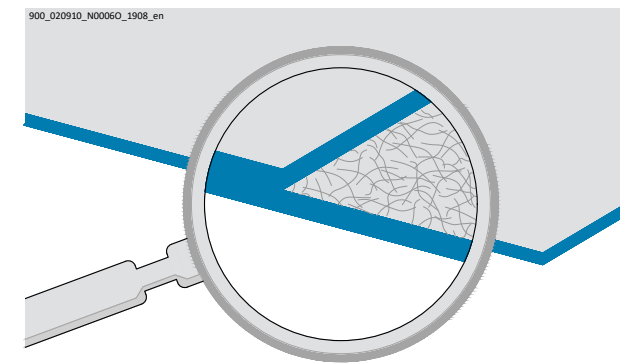

Sarnafil® TG 66

Sarnafil® TG 66 has a glass non-woven inlay. The fully embedded inlay of glass non-woven optimizes dimensional stability.

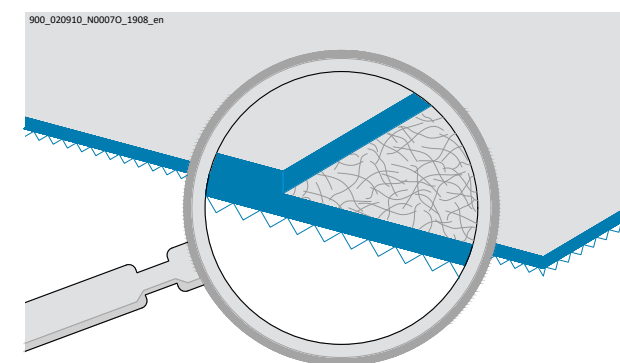

Sarnafil® TG 76 Felt PS / TG 76 E Felt PS

Sarnafil® TG 76 Felt PS / TG 76 E Felt PS has glass non-woven inlay and a polyester and glass mix fleece backing. The glass fleece inlay optimizes dimensional stability, the backing provides integrated separation and is keying for full surface adhesion.

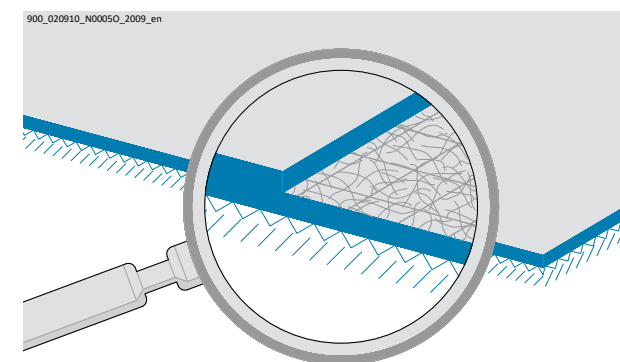

Sarnafil® TG 76 FSA

Sarnafil® TG 76-15 FSA has an internal glass fiber scrim reinforcement with a glass non-woven inlay and a polyester backing with self-adhesive film and liner. The glass fleece inlay optimizes dimensional stability and factory applied self-adhesive film provides instant surface adhesion.

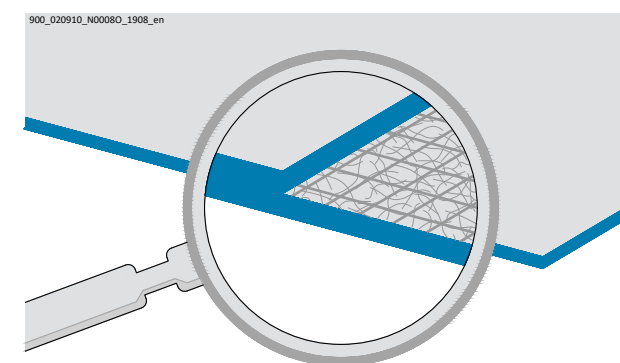

Sarnafil® TS 77 / TS 77 E

Sarnafil® TS 77 / TS 77 E has an internal polyester reinforcement and glass non-woven inlay. The glass fleece inlay optimizes dimensional stability, and the embedded reinforcement provides resistance to wind uplift.

T	Product family / group / type	12 / 15 / 18 / 20 / 25	Membrane thickness (in tenths of mm)
G	Glass non-woven inlay	E	Enhanced fire rating
S	Polyester reinforcement	Felt PS	Felt backing made of polyester
76 / 77	Material reference number	FSA	Felt with a self-adhesive film and liner

Sarnafil® T ROOF WATERPROOFING MEMBRANES

ROOF DESIGN

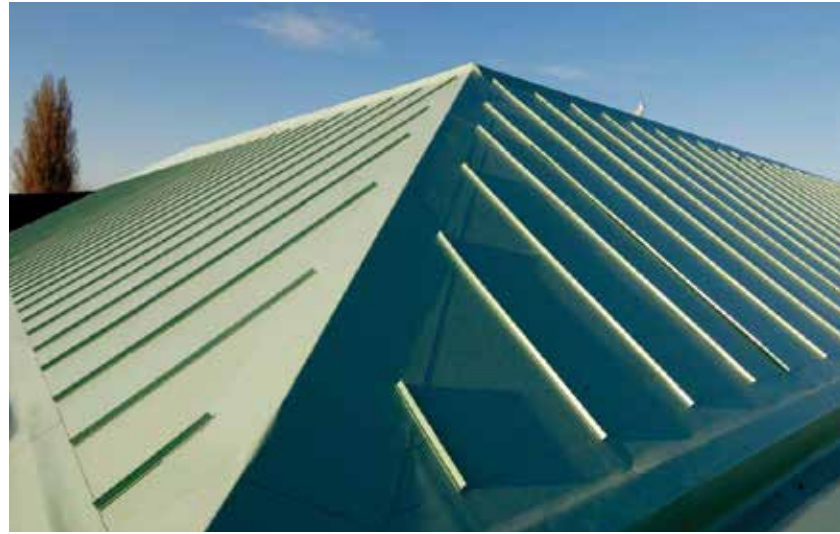

DECOR PROFILES

Sarnafil® T decor profiles can imitate the appearance of a sheet metal roof with a standing seam covering. The decorative profiles are particularly suitable for the renovation of old buildings where the original appearance is to be retained. In addition, architecturally attractive aspects can be set in relation to the roof design.



Sikagard® GRAPHICS

Sikagard®-950 is particularly suitable for graphic surface design of Sika Sarnafil® waterproofing membranes. For example, it can be used to color mark rescue and maintenance routes, to mark hospitals or to apply (company) logos, for example near airports or for satellite images on the Internet.











Sika Sarnafil® COLORS

Sika Sarnafil® waterproofing membranes are available in various colors. This allows the roof waterproofing to harmonise perfectly with the color of the building and its surroundings. For example, it matches red tiled roofs, green landscapes or blue skies.

Depending on the climate, the color of the roof waterproofing can also make a big difference to the interior climate of the building. In warm regions, for example, a white track with high solar reflection values is recommended.

Sarnafil® T ROOF WATERPROOFING MEMBRANES

COLOR CHART

BASIC COLORS	STANDARD COLORS	OTHER COLORS
Beige 	Reseda green  RAL 6011	On request
Light grey  RAL 7035	Basalt grey  RAL 7012	
Window grey  RAL 7040	Copper brown  RAL 8004	
	Traffic white  RAL 9016	
	Traffic white  RAL 9016 SR	

SR = Solar Reflective

Colors are similar to the given RAL colors (not identical). Attention, printing is not binding!

Availability for special and customized colors – contact your Sika sales organization.

PRODUCT OVERVIEW

Membrane type	Thickness	ROOF SYSTEMS							SUSTAINABILITY		PRODUCT CERTIFICATION		
		Mechanically fastened	Adhered	Green	Gravel ballasted	Utility	Inverted	Upstands	EPD	LEED	FM	FLL	BBA
Sarnafil® TG 66-12	1.20 mm			●*	●*	●*	●*	●		●			
Sarnafil® TG 66-15	1.50 mm			●	●	●	●	●	●	●		●	●
Sarnafil® TG 66-18	1.80 mm			●	●	●	●	●	●	●		●	●
Sarnafil® TG 66-20	2.00 mm			●	●	●	●	●	●	●		●	●
Sarnafil® TG 76-15 Felt PS	1.50 mm		●	○	○				●	●	●	●	●
Sarnafil® TG 76-18 Felt PS	1.80 mm		●	○	○				●	●	●	●	
Sarnafil® TG 76-20 Felt PS	2.00 mm		●	○	○				●	●	●	●	
Sarnafil® TG 76-15 E Felt PS	1.50 mm		●							●			
Sarnafil® TG 76-18 E Felt PS	1.80 mm		●							●			
Sarnafil® TG 76-20 E Felt PS	2.00 mm		●							●			
Sarnafil® TG 76-15 FSA	1.50 mm		●	○	○			○	●	●	●		
Sarnafil® TG 76-18 FSA	1.80 mm		●	○	○			○	●	●	●	●	
Sarnafil® TG 76-20 FSA	2.00 mm		●	○	○			○	●	●	●	●	
Sarnafil® TS 77-12	1.20 mm	●		○	○			○		●	●	●	
Sarnafil® TS 77-15	1.50 mm	●		○	○			○	●	●	●	●	●
Sarnafil® TS 77-18	1.80 mm	●		○	○			○	●	●	●	●	●
Sarnafil® TS 77-20	2.00 mm	●		○	○			○	●	●	●	●	●
Sarnafil® TS 77-25	2.50 mm	●		○	○			○	●	●	●	●	
Sarnafil® TS 77-12 E	1.20 mm	●						○		●	●		●
Sarnafil® TS 77-15 E	1.50 mm	●						○	●	●	●		●
Sarnafil® TS 77-18 E	1.80 mm	●						○	●	●	●		●
Sarnafil® TS 77-20 E	2.00 mm	●						○	●	●	●		●
Sarnafil® TG 63	various	Protection layer for ballasted roofs (not UV-resistant)											
Sarnafil® TG 66-15 D	1.50 mm	Homogeneous membrane for detailing											

● Standard
 ○ Suitable
 * Sarnafil® TG 66-15 is used favourably to Sarnafil® TG 66-12 for higher mechanical resistance to tear and wear

FM Factory Mutual – approval standard 4470
 FLL Forschungsgesellschaft Landschaftsentwicklung Landschaftsbau e.v. – resistance to root penetration, according to EN 13948
 BBA British Board of Agrément – approval inspection, testing certification
 EPD Environmental Product Declaration – as per ISO 14025 and 15804
 LEED Leadership in Energy & Environmental Design – green building rating system

EXTERNAL FIRE PERFORMANCE MECHANICALLY FASTENED ROOFS

Thermal insulation	Glass fleece	Membrane thickness	BROOF T1		BROOF T2		BROOF T3		BROOF T4	
			Sarnafil® TS 77	Sarnafil® TS 77 E	Sarnafil® TS 77	Sarnafil® TS 77 E	Sarnafil® TS 77	Sarnafil® TS 77 E	Sarnafil® TS 77	Sarnafil® TS 77 E
EPS*	yes	1.20 mm	< 20°	< 20°, > 20°						
	yes	1.50 mm	< 20°	< 20°, > 20°		●				
	yes	1.80 mm	< 20°	< 20°, > 20°		●				
	yes	2.00 mm	< 20°	< 20°, > 20°		●				
	yes	2.50 mm	< 20°	< 20°, > 20°						
PIR	no	1.20 mm	< 20°	< 20°, > 20°					< 10°	< 10°
	no	1.50 mm	< 20°	< 20°, > 20°				< 10°	< 10°	< 10°
	no	1.80 mm	< 20°	< 20°, > 20°				< 10°	< 10°	< 10°
	no	2.00 mm	< 20°	< 20°, > 20°				< 10°	< 10°	< 10°
	no	2.50 mm	< 20°	< 20°, > 20°					< 10°	< 10°
Mineralwool	no	1.20 mm	< 20°	< 20°, > 20°				< 10°	< 10°	< 10°
	no	1.50 mm	< 20°	< 20°, > 20°				< 10°	< 10°	< 10°
	no	1.80 mm	< 20°	< 20°, > 20°				< 10°	< 10°	< 10°
	no	2.00 mm	< 20°	< 20°, > 20°		●		< 10°	< 10°	< 10°
	no	2.50 mm	< 20°	< 20°, > 20°						
Wood	no	1.20 mm	< 20°	< 20°, > 20°						
	no	1.50 mm	< 20°	< 20°, > 20°						
	no	1.80 mm	< 20°	< 20°, > 20°						
	no	2.00 mm	< 20°	< 20°, > 20°						
	no	2.50 mm	< 20°	< 20°, > 20°						
Bitumen	no	1.20 mm	< 20°	< 20°, > 20°						
	no	1.50 mm	< 20°	< 20°, > 20°						
	no	1.80 mm	< 20°	< 20°, > 20°						
	no	2.00 mm	< 20°	< 20°, > 20°						
	no	2.50 mm	< 20°	< 20°, > 20°						
Concrete	no	1.20 mm	< 20°	< 20°, > 20°						
	no	1.50 mm	< 20°	< 20°, > 20°						
	no	1.80 mm	< 20°	< 20°, > 20°						
	no	2.00 mm	< 20°	< 20°, > 20°		●				
	no	2.50 mm	< 20°	< 20°, > 20°						

* Glass fleece min. 120 g/m²

EXTERNAL FIRE PERFORMANCE ADHERED ROOFS

Thermal insulation	Membrane thickness	BROOF T1			BROOF T2			BROOF T3			BROOF T4		
		Sarnafil® TG 76 Felt PS Sarnacol®-2142	Sarnafil® TG 76 E Felt PS Sarnacol®-2142	Sarnafil® TG 76 FSA	Sarnafil® TG 76 Felt PS Sarnacol®-2142	Sarnafil® TG 76 E Felt PS Sarnacol®-2142	Sarnafil® TG 76 FSA	Sarnafil® TG 76 Felt PS Sarnacol®-2142	Sarnafil® TG 76 E Felt PS Sarnacol®-2142	Sarnafil® TG 76 FSA	Sarnafil® TG 76 Felt PS Sarnacol®-2142	Sarnafil® TG 76 E Felt PS Sarnacol®-2142	Sarnafil® TG 76 FSA
EPS	1.50 mm	< 20°	< 20°, > 20°	< 20°									
	1.80 mm	< 20°	< 20°, > 20°	< 20°									
	2.00 mm	< 20°	< 20°, > 20°	< 20°									
PIR	1.50 mm	< 20°	< 20°, > 20°	< 20°		●					< 10°		
	1.80 mm	< 20°	< 20°, > 20°	< 20°							< 10°		
	2.00 mm	< 20°	< 20°, > 20°	< 20°							< 10°		
Mineralwool	1.50 mm	< 20°	< 20°, > 20°	< 20°							< 10°		
	1.80 mm	< 20°	< 20°, > 20°	< 20°							< 10°		
	2.00 mm	< 20°	< 20°, > 20°	< 20°							< 10°		
Wood	1.50 mm	< 20°	< 20°, > 20°	< 20°, > 20°		●							
	1.80 mm	< 20°	< 20°, > 20°	< 20°, > 20°									
	2.00 mm	< 20°	< 20°, > 20°	< 20°, > 20°									
Bitumen	1.50 mm	< 20°	< 20°, > 20°	< 20°, > 20°									
	1.80 mm	< 20°	< 20°, > 20°	< 20°, > 20°									
	2.00 mm	< 20°	< 20°, > 20°	< 20°, > 20°									
Concrete	1.50 mm	< 20°	< 20°, > 20°	< 20°, > 20°		●							
	1.80 mm	< 20°	< 20°, > 20°	< 20°, > 20°									
	2.00 mm	< 20°	< 20°, > 20°	< 20°, > 20°									
Metal Composite Panel	1.50 mm	< 20°	< 20°, > 20°	< 20°, > 20°		●					< 10°		
	1.80 mm	< 20°	< 20°, > 20°	< 20°, > 20°							< 10°		
	2.00 mm	< 20°	< 20°, > 20°	< 20°, > 20°							< 10°		

Sarnafil® T ROOF WATERPROOFING MEMBRANES

CHEMICAL RESISTANCE

The chemical resistance of Sarnafil® T roof waterproofing membranes generally depends on concentration, temperature and duration of exposure.

The table below shows the resistance of Sarnafil® T roof waterproofing membranes to a range of substances at an ambient temperature of +20°C. If exposed to certain substances mentioned below, discoloration or other surface changes may occur, but these have no influence on the waterproofing function (even in the long term). For example bitumen, lactic acid, bird droppings etc.

Contact your sales organisation for information on resistance to other substances and types of exposure you expect in your specific project.

Type	Assessment	Type	Assessment
Asphalt	●	Plasticizers	○
Bird droppings	●	Polystyrene	●
Bitumen	●	Polyurethan	●
Carbon black	●	Potash lye 5%	●
Common salt	●	Red algae	●
Detergents	●	Salt (without split / grit)	●
Diesel oil	⦿	Salt of	
Fats Animal / Vegetable	⦿	- Aluminium	●
Ferrous residue	●	- Ammonium	●
Fuel oil	⦿	- Calcium	●
Fungicide	●	- Potassium	●
Gasoline	○	- Sodium	●
Glycol	●	Sea water	●
Hydrochloric acid 5%	⦿	Silicone oil	⦿
Insecticides	●	Soft soap	●
Kerosene	⦿	Sulphuric acid 5%	⦿
Lactic acid	●	Tar	⦿
Lake water	●	Turpentine oil	⦿
Mineral oils (non-aromatic)	⦿	Urea	●
Motor oil	⦿	Water glass	●
Soda lye 5%	●	Wax	○
Oils		Weed killer	●
Animal / Vegetable	⦿	Weed killer (aqueous)	●
Paraffin	⦿	Wood preservative	
Paraffin oil	⦿	- Water-based	●
Petroleum	⦿	- Solvent-based	● ¹⁾

- Resistant
- ⦿ Conditionally resistant
- Non resistant

¹⁾ Paint needs to dry for at least 24 hours



Sarnafil® T ROOF WATERPROOFING MEMBRANES

PRODUCT PROPERTIES

Sarnafil® TG 66



Datasheet:
Sarnafil® TG 66

DESCRIPTION

Sarnafil® TG 66 is a multi-layer synthetic roof waterproofing sheet based on premium-quality flexible polyolefin (FPO) with glass non-woven inlay according to EN 13956. The fully embedded inlay of glass non-woven optimizes dimensional stability.

The Product is hot air weldable, UV resistant and designed to use in all global climatic conditions. The Product is suitable to also be applied to upstands, junctions, and in detailing.

USES

Roof waterproofing membrane for:

- Loosely laid and ballasted roofs
- Green roofs
- Utility roofs
- Inverted roofs

Roof waterproofing membrane for exposed roof junction zones:

- Roof waterproofing for junctions and flashings, e.g. wall and parapet junctions, roof lights, etc., which are permanently exposed in installations of Sarnafil® TG 66 roof waterproofing systems with ballast
- Roof waterproofing for junctions and flashings in installations of all types of Sarnafil® TS 77 and TG 76 Felt exposed roof waterproofing systems

CHARACTERISTICS / ADVANTAGES

- Proven performance over decades
- Resistant to micro-organism
- Resistant to root penetration
- High dimensional stability due to glass fleece inlay
- Resistant to permanent UV exposure
- Compatible to bitumen
- Resistant against impact load and hail
- Resistant to all common environmental influences
- Resistant to mechanical influences
- Hot air weldable
- Recyclable

APPEARANCE / COLOR

Surface:

- Matt
- Top surface:
 - Beige
 - Window grey (~ RAL 7040)
- Bottom surface:
 - Black

Please check color policy

Please check color policy

SYSTEM STRUCTURE

The following products must be considered for use depending on roof design:

- Sarnafil® T 66-15 D Sheet for detailing
- Sarnafil® T Metal Sheet
- Sarnafil® T Welding Cord
- Sarnabar®
- Sarnafil® T Prep / Sarnafil® T Wet Task Set
- Sarnacol® T 660
- Solvent T 660
- Sarnafil® T Clean

Wide range of accessories is available e.g. prefabricated parts, roof drains, scuppers, walkway pads and decor profiles.

Sarnafil® TG 76 Felt PS



Datasheet:
Sarnafil® TG 76 Felt PS

DESCRIPTION

Sarnafil® TG 76 Felt PS is a multi-layer synthetic roof waterproofing sheet based on premium-quality flexible polyolefin (FPO) containing stabilizers, with glass non-woven inlay and a polyester and glass mix fleece backing according to EN 13956.

The Product is hot air weldable, UV resistant and designed to use in all global climatic conditions. The glass fleece inlay optimizes dimensional stability, the backing provides integrated separation and is keying for full surface adhesion.

USES

Roof waterproofing membrane for:

- Adhered roofs

CHARACTERISTICS / ADVANTAGES

- Proven performance over decades
- Resistant to micro-organism
- Various colors available
- High dimensional stability due to glass fleece inlay
- Resistant to permanent UV exposure
- Compatible to bitumen
- Hot air weldable without use of open flames
- Recyclable

APPEARANCE / COLOR

Surface:

- Matt
- Top surface:
 - Beige
 - Window grey (~ RAL 7040)
 - Traffic white (~ RAL 9016)
- Bottom surface:
 - Black

Please check color policy

Please check color policy

SYSTEM STRUCTURE

The following products must be considered for use depending on roof design:

- Sarnafil® T 66-15 D Sheet for detailing
- Sarnafil® T Metal Sheet
- Sarnacol®-2142
- Sarnabar®
- Sarnafil® T Prep / Sarnafil® T Wet Task Set
- Sarnacol® T 660
- Solvent T 660
- Sarnafil® T Clean

Wide range of accessories is available e.g. prefabricated parts, roof drains, scuppers, walkway pads and decor profiles.

Sarnafil® T ROOF WATERPROOFING MEMBRANES

PRODUCT PROPERTIES

Sarnafil® TG 76 E Felt PS



DESCRIPTION

Sarnafil® TG 76 E Felt PS is a multi-layer synthetic roof waterproofing sheet based on premium-quality flexible polyolefin (FPO) containing stabilizers, with glass non-woven inlay and a polyester and glass mix fleece backing according to EN 13956.

The Product is hot air weldable, UV resistant and designed to use in all global climatic conditions. The glass fleece inlay optimizes dimensional stability, the backing provides integrated separation and is keying for full surface adhesion.

USES

Roof waterproofing membrane for:

- Adhered roofs

CHARACTERISTICS / ADVANTAGES

- Outstanding resistance to weathering, including permanent UV exposure
- Excellent flexibility in cold temperatures
- No built-in stress at the time of production
- High dimensional stability
- High resistance against impact load
- Excellent weldability
- No risk of delamination or water-wicking
- Compatible to old bitumen
- Recyclable

APPEARANCE / COLOR

Surface:

- Matt
- Top surface:
 - Beige
 - Window grey (~ RAL 7040)
 - Traffic white (~ RAL 9016)

Bottom surface:

- Black

Please check color policy

SYSTEM STRUCTURE

The following products must be considered for use depending on roof design:

- Sarnafil® T 66-15 D Sheet for detailing
- Sarnafil® T Metal Sheet
- Sarnacol®-2142
- Sarnabar®
- Sarnafil® T Prep / Sarnafil® T Wet Task Set
- Sarnacol® T 660
- Solvent T 660
- Sarnafil® T Clean

Wide range of accessories is available e.g. prefabricated parts, roof drains, scuppers, walkway pads and decor profiles.

Sarnafil® TG 76 FSA



DESCRIPTION

Sarnafil® TG 76 FSA is a multi-layer synthetic roof waterproofing sheet based on premium-quality flexible polyolefin (FPO) containing stabilizers. It has an internal glass fiber scrim reinforcement with a glass non-woven inlay and a Polyester backing with self-adhesive film and liner according to EN 13956.

The product is hot air weldable, UV resistant and designed to use in all global climatic conditions. The glass fleece inlay optimizes dimensional stability and factory applied self-adhesive film provides instant surface adhesion.

USES

Roof waterproofing membrane for:

- Adhered roofs

CHARACTERISTICS / ADVANTAGES

- Fast installation of membrane
- Instant wind uplift resistance through the self-adhesive backing
- Proven performance over decades
- High dimensional stability due to glass fleece inlay
- Resistant to permanent UV exposure
- Resistant to micro-organism
- Resistant against impact load and hail
- Hot air welding without use of open flames

APPEARANCE / COLOR

Surface:

- Matt
- Top surface:
 - Beige
 - Window grey (~ RAL 7040)
 - Traffic white (~ RAL 9016)

Bottom surface:

- Black

Please check color policy

SYSTEM STRUCTURE

The following products must be considered for use depending on roof design:

- Sarnafil® T 66-15 D Sheet for detailing
- Sarnafil® T Metal Sheet
- Sarnafil® T Welding Cord
- Sarnabar®
- Sarnafil® T Prep / Sarnafil® T Wet Task Set
- Sarnacol® T 660
- Solvent T 660
- Sarnafil® T Clean
- Primer 780

Wide range of accessories is available e.g. prefabricated parts, roof drains, scuppers, walkway pads and decor profiles.



Datasheet:

Sarnafil® TG 76 FSA

Sarnafil® T ROOF WATERPROOFING MEMBRANES

PRODUCT PROPERTIES

Sarnafil® TS 77



Datasheet:
Sarnafil® TS 77

DESCRIPTION

Sarnafil® TS 77 is a multi-layer synthetic roof waterproofing sheet based on premium-quality flexible polyolefin (FPO) containing stabilizers, with internal polyester reinforcement and glass non-woven inlay according to EN 13956. The Product is hot air weldable, UV resistant and designed to use in all global climatic conditions. The glass fleece inlay optimizes dimensional stability, and the embedded reinforcement provides resistance to wind uplift.

USES

Roof waterproofing membrane for:

- Mechanically fastened roofs

CHARACTERISTICS / ADVANTAGES

- Proven performance over decades
- Various colors available
- Resistant to permanent UV exposure
- High dimensional stability due to glass fleece inlay
- Resistant to permanent wind exposure
- Resistant to all common environmental influences
- Resistant to micro-organisms
- Resistant to root penetration
- Compatible to old bitumen
- Hot air weldable
- Recyclable

APPEARANCE / COLOR

Surface:

- Matt
- Top surface:
 - Beige
 - Window grey (~ RAL 7040)
 - Traffic white (~ RAL 9016)

Bottom surface:

- Black

Please check color policy

SYSTEM STRUCTURE

The following products must be considered for use depending on roof design:

- Sarnafil® T 66-15 D Sheet for detailing
- Sarnafil® TS 77 strips
- Sarnafil® T Metal Sheet
- Sarnafil® T Welding Cord
- Sarnabar® / Sarnafast®
- Sarnafil® T Prep / Sarnafil® T Wet Task Set
- Sarnacol® T 660
- Solvent T 660
- Sarnafil® T Clean

Wide range of accessories is available e.g. prefabricated parts, roof drains, scuppers, walkway pads and decor profiles.

Sarnafil® TS 77 E



Datasheet:
Sarnafil® TS 77 E

DESCRIPTION

Sarnafil® TS 77 E is a multi-layer synthetic roof waterproofing sheet based on premium-quality flexible polyolefin (FPO) containing stabilizers, with internal polyester reinforcement and glass non-woven inlay according to EN 13956. The Product is hot air weldable, UV resistant and designed to use in all global climatic conditions. The glass fleece inlay optimizes dimensional stability, and the embedded reinforcement provides resistance to wind uplift.

USES

Roof waterproofing membrane for:

- Mechanically fastened roofs

CHARACTERISTICS / ADVANTAGES

- Proven performance over decades
- Various colors available
- Resistant to permanent UV exposure
- High dimensional stability due to glass fleece inlay
- Resistant to permanent wind exposure
- Resistant to all common environmental influences
- Resistant to micro-organisms
- Compatible to old bitumen
- Hot air weldable
- Recyclable

APPEARANCE / COLOR

Surface:

- Matt
- Top surface:
 - Beige
 - Window grey (~ RAL 7040)
 - Traffic white (~ RAL 9016)

Bottom surface:

- Black

Please check color policy

SYSTEM STRUCTURE

The following products must be considered for use depending on roof design:

- Sarnafil® T 66-15 D Sheet for detailing
- Sarnafil® TS 77 E strips
- Sarnafil® T Metal Sheet
- Sarnafil® T Welding Cord
- Sarnabar® / Sarnafast®
- Sarnafil® T Prep / Sarnafil® T Wet Task Set
- Sarnacol® T 660
- Solvent T 660
- Sarnafil® T Clean

Wide range of accessories is available e.g. prefabricated parts, roof drains, scuppers, walkway pads and decor profiles.

DETAILING MEMBRANE

Sarnafil® T 66-15 D



DESCRIPTION

Sarnafil® T 66-15 D is an unreinforced multi-layer, synthetic roof waterproofing sheet based on flexible polyolefins (FPO). Sarnafil® T 66-15 D is a hot air weldable, UV-resistant roof detailing membrane.

USES

Detailing sheet for Sarnafil® T roof waterproofing membranes:

- Welded to the installed Sarnafil® T roof waterproofing membranes

CHARACTERISTICS / ADVANTAGES

- Resistant to permanent UV exposure
- Resistant to most common environmental influences
- Resistant to micro organisms
- Resistant to old bitumen
- Hot air welding without use of open flame
- Can be applied on either side as both surfaces have a different color

APPEARANCE / COLOR

Surface:

- Matt
- Top surface:
 - Beige
 - Window grey (~ RAL 7040)

Bottom surface:

- Beige
- Window grey (~ RAL 7040)
- Other colors on request

TECHNICAL INFORMATION

Length: 20.00 m
Width: 0.50 m
Thickness: 1.50 mm

METAL SHEET / COIL

Sarnafil® T Metal Sheet / Coil



DESCRIPTION

Sarnafil® T Metal Sheet / Coil is a galvanized steel sheet or coil, laminated with Sarnafil® T flexible polyolefin (FPO) roof waterproofing membrane.

USES

Production of profiles for perimeter fastenings and junctions:

- Sarnafil® T (FPO) roof waterproofing membrane systems

CHARACTERISTICS / ADVANTAGES

- Resistant to UV exposure
- Can be cut and shaped either on site or in metal workshop
- Sarnafil® T lamination is hot air weldable

APPEARANCE / COLOR

Surface:

- Smooth
- Top surface:
 - Beige
 - Window grey (~ RAL 7040)
 - Other colors on request
- Bottom surface:
 - Metal: cut (Epoxy-protection coated)

TECHNICAL INFORMATION

Sarnafil® T Metal Sheet
Length: 2.00 m / 3.00 m
Width: 1.00 m / 1.00 m

Sarnafil® T Metal Coil

Length: 30.00 m
Width: 1.00 m

Thickness:

Sarnafil® T lamination: 1.10 mm
Galvanised metal: 0.60 mm
Total thickness: 1.70 mm

WELDING PREPARATION / CLEANERS

Sarnafil® T Prep



DESCRIPTION

Mixture of organic solvents.

USES

Sarnafil® T Prep is used to prepare seams of Sarnafil® TG and TS in order to ensure optimum seam quality. Sarnafil® T Prep is also suitable as general purpose cleaner to remove light dirt or bitumen residue from Sarnafil® TG and TS.

CHARACTERISTICS / ADVANTAGES

- Ensures optimum seam quality
- Dissolves surface dirt
- Evaporates quickly
- Highly flammable

Sarnafil® Wet Task-Set



DESCRIPTION

The Wet Task-Set includes a dispenser bucket and a roll of 280 solvent-resistant white cloth.

USES

The set is filled with 5 litres of Sarnafil® T Prep and the lid firmly closed. The cloth removed through the dispenser opening are soaked with Sarnafil® T Prep for economical seam preparation. A volume fleece roll (refill towels) is offered for the reusable dispenser bucket.

CHARACTERISTICS / ADVANTAGES

- Economical method of seam preparation, as clean, impregnated cloths are always available
- Refillable
- No discoloration of the towels
- Lint-free
- Significantly lower cleaner consumption



Sarnafil® Seam Preparation Cloths



DESCRIPTION

The Sarnafil® Seam Preparation Cloths consist of 150 white, solvent-resistant fleece cloths (6 x 25 cloths).

USES

The Sarnafil® seam preparation cloths are an aid for seam pretreatment and possible cleaning. The cloths must be changed during cleaning. Fresh cloths should be used for seam pretreatment. Wipes soaked with Sarnafil® T Clean must not be used for seam pre-treatment with Sarnafil® T Prep.

CHARACTERISTICS / ADVANTAGES

- No discoloration of the towels
- Lint-free
- Significantly lower cleaner consumption

Sarnafil® T Clean



DESCRIPTION

Mixture of organic solvents.

USES

Sarnafil® T Clean is a cleaner to remove heavy soiling and adhesive residues from Sarnafil® TG and TS membranes. Sarnafil® T Clean is also suitable for cleaning tools and degreasing metal sheets.

CHARACTERISTICS / ADVANTAGES

- Dissolves surface dirt
- Evaporates quickly
- Suitable for heavily stained seam overlaps of Sarnafil® T membranes
- Highly flammable

Solvent T-660



DESCRIPTION

Mixture of high volatile solvents.

USES

Solvent T-660 is used to dilute Sarnacol® T-660 adhesive and to remove adhesive residues from Sarnafil® T (FPO) membranes. It is also used for cleaning tools and degreasing metal sheets.

CHARACTERISTICS / ADVANTAGES

- Optimal dilution/thinning of Sarnacol® T-660 adhesive
- Dissolves contaminations and adhesive resin
- Evaporates quickly
- Highly flammable
- Suitable to remove adhesive residues from seam
- Overlaps of Sarnafil® T membranes

SOLVENT FREE CLEANERS

SikaRoof® Clean Set Detail



DESCRIPTION

SikaRoof® Clean Set Detail consists of various cleaning items.

USES

To clean small areas of polymeric membrane surfaces.

CHARACTERISTICS / ADVANTAGES

- Fast and easy to use
- Water-based cleaning liquid
- Economical usage

SikaRoof® Clean Set Area



DESCRIPTION

The SikaRoof® Clean Set Area consists of various cleaning items.

USES

To clean polymeric membrane surfaces.

CHARACTERISTICS / ADVANTAGES

- Fast and easy to use

SikaRoof® Clean Pad Detail



DESCRIPTION

SikaRoof® Clean Pad Detail is a pad to clean polymeric roofing membranes.

USES

To clean polymeric membrane surfaces in combination with the SikaRoof® Clean Set Detail.

CHARACTERISTICS / ADVANTAGES

- Fast and easy to use

SikaRoof® Clean Pad Area



DESCRIPTION

The SikaRoof® Clean Pad Area is a pad to clean polymeric roofing membranes.

USES

To clean polymeric membrane surfaces in combination with the SikaRoof® Clean Set Area.

CHARACTERISTICS / ADVANTAGES

- Fast and easy to use

SikaRoof® Clean Agent



DESCRIPTION

The SikaRoof® Clean Agent is a mild alkaline cleaning agent for roof water-proofing membranes.

USES

To clean polymeric membrane surfaces in combination with the SikaRoof® Clean Set Detail and area.

CHARACTERISTICS / ADVANTAGES

- Water-based
- Economical usage

ADHESIVES, PRIMERS AND SEALANTS

Sarnacol® T-660



DESCRIPTION

Butyl rubber based one-pack contact adhesive.

USES

To bond Sarnafil® TG 66 and TS 77 membranes in perimeter and flashing areas.

CHARACTERISTICS / ADVANTAGES

- Adheres to solid, rough and clean surfaces

Sarnacol®-2142 S / -2142 V



DESCRIPTION

Sarnacol®-2142 S is a 1-part, polyurethane based moisture curing adhesive.

Sarnacol®-2142 V is a VOC free, 1-part, polyurethane based moisture curing adhesive.

USES

Bonding Sarnafil® T Felt-type membranes to roof substrates.

CHARACTERISTICS / ADVANTAGES

- Proven performance over decades.
- Adheres to solid, rough, clean, dry or slightly moist surfaces
- Application by roller
- Good adhesion to different substrates
- VOC free (Sarnacol®-2142 V)

Sarnacol®-2116



DESCRIPTION

Sarnacol®-2116 is a water based 1-part synthetic resin based adhesive.

USES

Binder for binding gravel on horizontally applied Sarnafil® T membranes (not for bonding).

SikaRoof® Tape P



DESCRIPTION

SikaRoof® Tape P is a polyacrylate double-sided adhesive tape used with Sarnafil® T roof membranes. SikaRoof® Tape P may only be used by experienced professionals.

USES

Bonds Sarnafil® T roofing membranes to a range of upstand substrates.

CHARACTERISTICS / ADVANTAGES

- High tack and long-term adhesion
- Finger-lift release liner
- Contains no halogen or heavy-metal compounds
- Easily applied

TECHNICAL INFORMATION

Length: 25.00 m
Width: 115.00 mm
Thickness: Overall 0.50 mm

SikaRoof® Multitape



DESCRIPTION

SikaRoof® Multitape is a single-sided adhesive tape. It has a FPO membrane layer and a butyl rubber adhesive layer.

USES

The Product bonds to a wide range of substrates:

- FPO waterproofing membrane
- PVC waterproofing membrane
- Metal
- Concrete
- Plywood
- Bitumen sanded or slated

The Product may only be used by experienced professionals.

CHARACTERISTICS / ADVANTAGES

- High tack and long-term adhesion
- Finger-lift release liner
- UV-resistant PP membrane layer
- Easy to apply with instant adhesion

APPEARANCE / COLOR

Color:
■ Beige
■ Window grey (~RAL 7040)
■ White (~RAL 9016)

TECHNICAL INFORMATION

Length: 15.00, 15.00 and 12.50 m
Width: 100, 170 and 250 mm
Thickness: Overall 1.70 mm

SikaRoof® Board Adhesive



DESCRIPTION

SikaRoof® Board Adhesive is a polyurethane 1-part, fast curing, gun grade, foam adhesive that bonds insulation boards to various types of construction material substrates.

USES

Insulation board types:

- Extruded polystyrene boards (XPS)
- Expanded polystyrene boards (EPS)
- PUR/PIR boards
- Mineral fibre boards with sufficient compressive strength and appropriate type of bonding surface

CHARACTERISTICS / ADVANTAGES

- Easy, efficient and clean application with spray application gun
- One container covers an area of up to ~18 m²
- Fast moisture curing for quick bonding
- Fire Behaviour B1 class (DIN 4102-1)
- Good adhesive tensile strength
- Adheres to solid, clean, dry or slightly moist surfaces
- HFC-free



Brochure:
[SikaRoof® Board Adhesive](#)



Brochure:
[SikaRoof® Multitape](#)



Video:
[SikaRoof® Multitape the self-adhered tape](#)

ADHESIVES, PRIMERS AND SEALANTS

Sika® Primer-3 N



DESCRIPTION

Sika® Primer-3 N is a solvent-based, 1-component primer.

USES

Sika® Primer-3 N is designed for Sikaflex®, SikaHyflex®, SikaBond® and Sikasil® products used on porous substrates (e.g. concrete) and metals.

CHARACTERISTICS / ADVANTAGES

- Easy to apply
- Water repellent
- Short flash-off time

Primer-780



DESCRIPTION

Water based dispersion primer.

USES

Primer-780 is a ready to use product, used for applying self-adhered Membrane:

- Sarnafil® TG 76 FSA onto various substrates

CHARACTERISTICS / ADVANTAGES

- Solvent free
- Fast drying
- High adhesion to different structural decks and substrates
- Application at 5°C

S-Sealing Tape 10/10



DESCRIPTION

S-Sealing Tape 10/10 is a polyurethane, single-sided adhesion soft foam sealing tape with acrylate dispersion impregnation.

USES

Placed between laminated metal sheet flashings and the substrate to prevent the penetration of wind driven water.

CHARACTERISTICS / ADVANTAGES

- Easily applied strip with integral adhesive and release liner
- Finger-lift release liner

APPEARANCE / COLOR

- Color:
- Grey
 - Black

TECHNICAL INFORMATION

Length: 25.00 m
Width: 10 mm
Thickness: 10 mm

Sika® Aktivator-205



DESCRIPTION

Sika® Aktivator-205 is a solvent-based colourless clear adhesion promoter, which reacts with moisture and deposits active groups on the substrate. These groups act as a link between substrates and primers or sealants / adhesives. Sika® Aktivator-205 is designed for the treatment of bond faces prior to application of Sikaflex® and Sikasil® adhesives and sealants.

USES

Sika® Aktivator-205 is used to improve adhesion on non-porous substrates such as metals, plastics, ceramic screen prints

and painted surfaces. Seek manufacturer's advice and perform tests on original substrates before using Sika® Aktivator-205 on materials prone to stress cracking. This product is suitable for experienced professional users only. Tests with actual substrates and conditions have to be performed to ensure adhesion and material compatibility.

CHARACTERISTICS / ADVANTAGES

- Enhanced adhesion on various substrates
- Short flash-off time
- Easy to use
- Transparent

ADHESIVES, PRIMERS AND SEALANTS

Sikaflex®-11 FC Purform®



DESCRIPTION

Sikaflex®-11 FC Purform® is a 1-part moisture curing elastic adhesive and sealant. It is used for interior and exterior multipurpose bonding and joint sealing. It has good and durable adhesion to most construction materials.

USES

An adhesive to bond construction components and materials such as:

- Concrete
- Masonry
- Reconstituted or cast stone
- Ceramic
- Wood
- Metal
- Glass

A sealant to seal vertical and horizontal joints

CHARACTERISTICS / ADVANTAGES

- Movement capability of ± 25 %
- Easy to apply and non-sagging
- Bonds well to most construction materials
- Good mechanical and weathering resistance
- Very low monomer content
- No training on the safe use of diisocyanates (REACH) required
- Adhesive-sealant with CE marking

Sarnaplast®-2235



DESCRIPTION

Sarnaplast®-2235 is a 1-part transparent elastomeric silicone sealant for sealing connection details on Sarnafil® flat roof systems.

USES

Sarnaplast®-2235 may only be used by experienced professionals.

A Sealant to seal:

- Flashing joints
- Expansion joints
- Perimeter flashings

CHARACTERISTICS / ADVANTAGES

- Resistant to UV exposure
- Application onto rough and smooth substrates
- Bonds to most construction materials
- Applied using standard sealant gun

SikaBond® TF plus N



DESCRIPTION

SikaBond® TF plus N is a 1-component, PU-based adhesive for the SikaMembran® facade membrane system, which combines high mechanical strength with the necessary elasticity to cope with high movements in facades. SikaBond® TF plus N adheres excellent to a wide range of substrates.

USES

This product is suitable for experienced professional users only. Test with actual substrates and conditions have to be performed to ensure adhesion and material compatibility.

CHARACTERISTICS / ADVANTAGES

- Secure application with good sag resistance bonds well to concrete, aluminium (anodized or powder-coated), rigid U-PVC, timber and other standard construction materials
- Application of adhesive to one side only (mostly to substrate)
- Ensures levelling of substrate
- No contact pressure necessary
- Fast curing adjustment of membrane possible until 30 min. after installation

RELEASED / APPROVED APPLICATIONS FOR SEALANTS

Sealant		Sikaflex®-11 FC Purform®	Sarnaplast®-2235	SikaBond® TF plus N
Application		Various	Various	EPDM Connection
Membranes and Metal Sheets	Sarnafil® TG 66 / TS 77	Sikalastic® Primer FPO	Sikalastic® Primer FPO	Sikalastic® Primer FPO
	Sarnafil® T Metal Sheet (Bottom surface)	None	Solvent T-660 (Sarnafil® T Clean)	None
Substrates	Concrete, natural stone	Sika® Primer-3 N	Sikalastic® Primer FPO	Sika® Primer-3 N
	Fibre cement	Sika® Primer-3 N	Sikalastic® Primer FPO	Sika® Primer-3 N
	Copper	Not tested	Not tested	Not tested
	Aluminium uncoated	Abrasive treatment + Sika® Aktivator-205	Sikalastic® Primer FPO	Abrasive treatment + Sika® Aktivator-205
	Aluminium anodised	Sika® Aktivator-205	Sikalastic® Primer FPO	Sika® Aktivator-205
	Titanium zinc	Sika® Aktivator-205	Sikalastic® Primer FPO	Sika® Aktivator-205
	Steel	Sika® Aktivator-205	Sikalastic® Primer FPO	Sika® Aktivator-205
	EPDM	Not compatible	Not compatible	None

Information regarding Sikalastic® Primer FPO to be found under: [Sikalastic® Primer FPO](#) on page 144

PREFABRICATED PRODUCTS

Sarnafil® T Preformed Components CI / WA



DESCRIPTION

The Sarnafil® T Preformed Components corner are made of homogeneous flexible polyolefins by injection moulding.

USES

The Sarnafil® T Preformed Components parts (inner and outer corners) are used:

- In the connection area of the Sarnafil® flat roof systems

CHARACTERISTICS / ADVANTAGES

- Resistant to UV exposure
- Ease and safe application
- Hot air weldable

APPEARANCE / COLOR

- Surface:
- Smooth
- Top surface:
- Beige
 - Window grey (~ RAL 7040)
 - Other colors on request

Sarnafil® T Corner 90° I / A



DESCRIPTION

Sarnafil® T Corner 90° I / A is based on flexible polyolefins (FPO) manufactured by injection moulding.

USES

Sarnafil® T Corner 90° I / A may only be used by experienced professionals.

- Prefabricated corners for Sarnafil® T flat roof systems

CHARACTERISTICS / ADVANTAGES

- Resistant to UV exposure
- Ease and safe application
- Hot air weldable

APPEARANCE / COLOR

- Surface:
- Smooth
- Top surface:
- Beige
 - Window grey (~ RAL 7040)
 - Other colors on request

Sarnafil® T Pipe Flashing



DESCRIPTION

Sarnafil® T Pipe Flashing is made of synthetic roof waterproofing membrane based on premium-quality flexible polyolefins (FPO), containing stabilizers, with inlay of glass non-woven.

USES

Sarnafil® T Pipe Flashing is used as a prefabricated part for:

- Pipe / vent flashing on Sarnafil® T flat roof systems

CHARACTERISTICS / ADVANTAGES

- Resistant to UV exposure
- Ease and safe application
- Hot air weldable

APPEARANCE / COLOR

- Surface:
- Smooth
- Top surface:
- Beige
 - Window grey (~ RAL 7040)
 - Other colors on request

Sarnafil® T Post Flashing



DESCRIPTION

Sarnafil® T Post Flashing is a prefabricated roof post flashing based on an FPO waterproofing membrane.

USES

Sarnafil® T Post Flashing may only be used by experienced professionals.

- Post flashing on Sarnafil® T flat roof systems

CHARACTERISTICS / ADVANTAGES

- Resistant to UV exposure
- Ease and safe application
- Hot air weldable

APPEARANCE / COLOR

- Surface:
- Smooth
- Top surface:
- Beige
 - Window grey (~ RAL 7040)
 - Other colors on request

Sarnafil® T Point Flashing



DESCRIPTION

Sarnafil® T Point Flashing is a prefabricated injection moulded roof point flashing based on a flexible polyolefin (FPO) with fitted integrated heat shrink sleeve.

USES

Post flashing on Sarnafil® T flat roof systems.

CHARACTERISTICS / ADVANTAGES

- Resistant to UV exposure
- Easy and safe application
- Heat weldable
- Fitted integrated heat shrink sleeve

APPEARANCE / COLOR

- Surface:
- Smooth
- Top surface:
- Beige
 - Window grey (RAL 7040)
 - Other colors on request

TECHNICAL INFORMATION

Inside pipe conical diameter:
17 mm, 20 mm, 21 mm, 24 mm
Diameter base plate: 180 mm
Height: 250 mm
Thickness: 2.00 mm

Sarnafil® T Lightning Conductor Flashing



DESCRIPTION

Sarnafil® T Lightning Conductor Flashing is made of premium-quality flexible polyolefin (FPO) by injection moulding procedure.

USES

Sarnafil® T Lightning Conductor Flashing is used as a prefabricated part for:

- Lightning Conductor Flashing on Sarnafil® T flat roof systems

CHARACTERISTICS / ADVANTAGES

- Resistant to UV exposure
- Ease and safe application
- Hot air weldable
- Product is delivered incl. shrink hose

APPEARANCE / COLOR

- Surface:
- Smooth
- Top surface:
- Beige
 - Window grey (~ RAL 7040)
 - Other colors on request

TECHNICAL INFORMATION

Diameter base plate: 160 mm
Inside pipe diameter conical: 11.00 - 15.00 mm
Height: 250 mm
Thickness: 2.00 mm

PREFABRICATED PRODUCTS

Sarnafil® T Lightning Conductor Circus



DESCRIPTION

Sarnafil® T Lightning Conductor Circus is a flexible polyolefin (FPO) lightning conductor clip connecting disc formed from FPO waterproofing membrane.

USES

This product may only be used by experienced professionals:

- Connects S-Lightning Conductor Clips and S-Lightning Conductor Clips (V2A) to Sarnafil® TG / TS membranes roof membranes

CHARACTERISTICS / ADVANTAGES

- Resistant to UV exposure
- Hot air weldable without the use of open flames

APPEARANCE / COLOR

Surface:

- Matt

Color:

Top surface:

- Beige

Bottom surface:

- Beige

TECHNICAL INFORMATION

Diameter: 200 mm

Centre hole diameter: 23 mm

Thickness: 1.50 mm

S-Lightning Conductor Clip



DESCRIPTION

S-Lightning Conductor Clip is a polyamide / Nylon (PA) clip for securing lightning conductor cables to Sarnafil® roof membranes.

USES

S-Lightning Conductor Clip may only be used by experienced professionals:

- S-Lightning Conductor Clip is used as lightning conductor clip on flat roofs. Suitable for conductor Ø 8 mm – 10 mm

CHARACTERISTICS / ADVANTAGES

- Resistant to UV exposure
- Suitable for Sarnafil® FPO flat roof systems

APPEARANCE / COLOR

Top surface:

- Grey

TECHNICAL INFORMATION

Base plate: Ø 110 mm

Height: 45 mm

S-Lightning Conductor Clip V2A



DESCRIPTION

S-Lightning Conductor Clip V2A is a stainless steel clip on a polyamide / nylon support base which is used for securing lightning conductor cables to Sarnafil® roof membranes.

USES

This product may only be used by experienced professionals:

- Lightning conductor cable clip for flat roofs with conductor cable diameters in the range of 8 mm to 10 mm

CHARACTERISTICS / ADVANTAGES

- Resistant to UV exposure
- Suitable for Sarnafil® FPO flat roof systems

APPEARANCE / COLOR

Top surface:

- Grey

TECHNICAL INFORMATION

Base plate: Ø 110 mm

Height: 40 mm

ROOF DRAINAGE

Sarnafil® T Gully Set



DESCRIPTION

The Sarnafil® T Gully Set is a prefabricated rigid polypropylene rainwater outlet for flat roofs used with Sarnafil® T roofing membranes. It is also available with a combined heating system.

USES

The Sarnafil® T Gully Set may only be used by experienced professionals:

- Rainwater outlet for use with Sarnafil® T roofing membranes

CHARACTERISTICS / ADVANTAGES

- Resistant to UV exposure
- Membrane can be welded directly to the base plate
- Hot air weldable
- Vapour control layer can be connected to the base plate to form an airtight seal

APPEARANCE / COLOR

Surface:

- Smooth

Color:

- Beige

Sarnafil® T Gully Horizontal / Vertically



DESCRIPTION

The Sarnafil® T Gully is made of high quality pressure stable polyolefin injection moulding. The product is available with or without heating.

The Sarnafil® T Gully consists of:

- Sarnafil® T Gully, thermally insulated, incl. built-in backwater seal
- Gravel basket

USES

The Sarnafil® T Gully is used for drainage of flat roofs.

CHARACTERISTICS / ADVANTAGES

- Simple electrical connection
- Sarnafil® T waterproofing membranes can be welded directly to the flange
- Easy application
- Meets the standards of DIN EN 1253

APPEARANCE / COLOR

Surface:

- Smooth

Color:

- Beige

TECHNICAL INFORMATION

Electrical connection:

Main Voltage: 230 V

Connected load: 15 Watt



ROOF DRAINAGE

Sarnafil® T Drain



DESCRIPTION

Sarnafil® T Drain is an FPO (PP) pre-fabricated injection moulded rainwater outlet for flat roofs. Outlet is used with Sarnafil® T roofing membranes which are heat welded onto the baseplate.

USES

Sarnafil® T Drain may only be used by experienced professionals:

- Rainwater outlet for use with Sarnafil® T roofing membranes

CHARACTERISTICS / ADVANTAGES

- Resistant to UV exposure
- Membrane can be welded directly onto the base plate
- Ease of application
- Hot air weldable

APPEARANCE / COLOR

Surface:

- Smooth

Top surface:

- Beige

S-Gully Overflow screw-on device



DESCRIPTION

S-Gully Overflow screw-on device is a polypropylene (PP) flat roof gully overflow manufactured by injection moulding.

USES

This product may only be used by experienced professionals:

- An overflow screw-on device for Sarnafil® T Gully, Sarnafil® T add-on element Ø 125 flat roofs systems

CHARACTERISTICS / ADVANTAGES

- Resistant to UV exposure
- Height adjustable from 30 mm to 65 mm
- Easily inserted into top of gully

APPEARANCE / COLOR

Surface:

- Smooth

Top surface:

- Red / black

Sarnafil® T Overflow - round



DESCRIPTION

The Sarnafil® T Overflow - round has a straight tray and is made of high-quality pressure-resistant PP (polypropylene) injection moulding.

USES

The Sarnafil® T Overflow - round is used:

- For flat roof waterproofing as an emergency overflow with horizontal pipe penetration through roof edge upstands

CHARACTERISTICS / ADVANTAGES

- Sarnafil® T roof waterproofing membranes can be welded directly to the flange
- Easy application
- Special lengths available on request

APPEARANCE / COLOR

Surface:

- Smooth

Top surface:

- Beige

Sarnafil® T Overflow - square

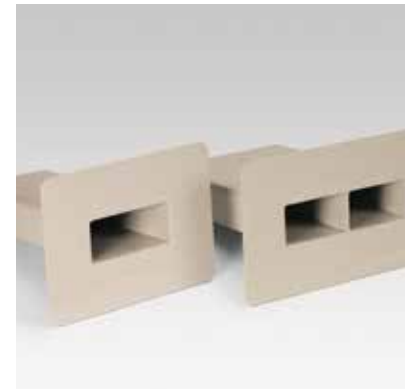

DESCRIPTION

Sarnafil® T Overflow - square is a pre-fabricated rigid FPO overflow outlet for flat roofs.

USES

This product may only be used by experienced professionals:

- Overflow outlet through flat roof parapets for use with Sarnafil® T roofing membranes

CHARACTERISTICS / ADVANTAGES

- Resistant to UV exposure
- Membrane can be welded directly to the base plate
- Hot air weldable

APPEARANCE / COLOR

Surface:

- Smooth

Top surface:

- Silk grey (~ RAL 7044)

Sarnafil® T Scupper - round



DESCRIPTION

Sarnafil® T Scupper - round is a rigid polyolefin prefabricated injection moulded rainwater outlet for flat roofs used with Sarnafil® T roof waterproofing membranes which can be heat welded onto the drain.

USES

Rainwater outlet through the parapet for use with Sarnafil® T roofing membranes.

CHARACTERISTICS / ADVANTAGES

- Resistant to UV exposure
- Membrane can be welded directly to the base plate
- Ease of application
- Hot air weldable

APPEARANCE / COLOR

Surface:

- Smooth

Top surface:

- Beige

Sarnafil® T Scupper - square

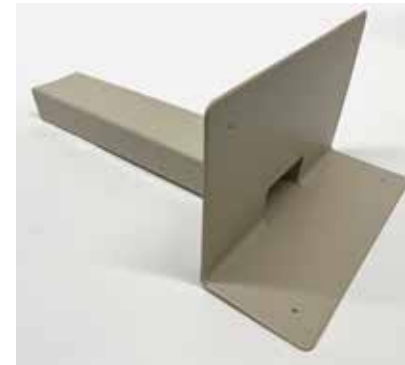

DESCRIPTION

Sarnafil® T Scupper square is a prefabricated FPO (PP) rainwater outlet through the parapet on flat roofs. It is used with Sarnafil® T roof waterproofing membranes which are heat welded onto the baseplate.

USES

Rainwater outlet for use with Sarnafil® T roof waterproofing membranes.

CHARACTERISTICS / ADVANTAGES

- Resistance to permanent UV exposure
- Membrane can be welded directly to the base plate
- Easy of application
- Hot air weldable

APPEARANCE / COLOR

Surface:

- Smooth

Top surface:

- Beige

ROOF DRAINAGE

SikaRoof® Drain Inspection chamber



DESCRIPTION

SikaRoof® Drain inspection chamber is a high density fibre reinforced concrete inspection chamber for accessing drains on green roofs.

USES

SikaRoof® Drain inspection chamber may only be used by experienced professionals:

- Accessing drains on green roofs

CHARACTERISTICS / ADVANTAGES

- Easy to install
- Insulated lid

APPEARANCE / COLOR

Surface:
 ■ Smooth
 Top surface:
 ■ Brown

TECHNICAL INFORMATION

Frame: 350 mm × 350 mm × 120 mm
 Thickness: 10 mm
 Lid insulation: 20 mm XPS board

S-Leafguard round



DESCRIPTION

S-Leafguard round is a prefabricated Polypropylene (PP) basket with fixing wing nut.

USES

This product may only be used by experienced professionals:

- The S-Leafguard round is used as a gravel and leaf protection for Sarnafil® T-Drains in flat roofs

CHARACTERISTICS / ADVANTAGES

- Resistant to UV exposure
- Ease of application

APPEARANCE / COLOR

Surface:
 ■ Smooth

TECHNICAL INFORMATION

Basket outside diameter: 237 mm
 Basket height: 82 mm

S-Duoseal Couplings



DESCRIPTION

The S-Duoseal Couplings is made of ethylene propylene diene monomer rubber (EPDM) by injection moulding procedure.

USES

The S-Duoseal Couplings is used with Sarnafil® T Drain.

- It provides an economic method of solving the problem of sealing a new Sarnafil® T Drain into an existing roof drain during a roof refurbishment.

CHARACTERISTICS / ADVANTAGES

- Ease of application
- Secure and durable backflow seal
- Each S-Duoseal Couplings fits a wide range of sizes

Gravel Frame with adjustable put on frame



DESCRIPTION

Gravel Frame with adjustable put on frame is a stainless steel gravel frame with adjustable insert (put on frame) for ballasted terraces.

USES

Gravel protection for roof drains in ballasted flat roof systems.

CHARACTERISTICS / ADVANTAGES

- Adjustable height: 50 – 80 mm
- Ease of application over gully

APPEARANCE / COLOR

Surface:
 ■ Smooth
 Top surface:
 ■ Stainless steel

TECHNICAL INFORMATION

Dimensions: 200 × 200 × 50 – 80 mm
 Thickness: 1.00 mm

Perforated strainer



DESCRIPTION

Perforated strainer is a prefabricated, stainless steel, strainer for ballasted roof drainage systems.

USES

This product may only be used by experienced professionals:

- Perforated strainer for the Sika Gravel Frame with adjustable frame insert (put on frame)

CHARACTERISTICS / ADVANTAGES

- Easily placed into gully frame

APPEARANCE / COLOR

Surface:
 ■ Smooth
 Color:
 ■ Stainless steel

TECHNICAL INFORMATION

Dimensions: 195 × 195 × 20 mm
 Thickness: 1.00 mm

ANCILLARY COMPONENTS

S-Gravelstop Profile

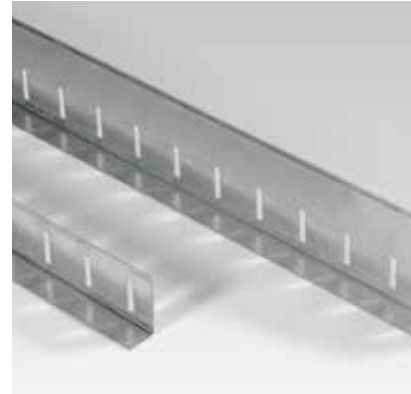

DESCRIPTION

S-Gravelstop Profile is a perforated stainless steel gravel stop profile for ballasted flat roofs.

USES

Gravel stop at roof perimeters in ballasted roofing systems or other ballast free roof areas:

- Separation profile between different types of roof ballast

CHARACTERISTICS / ADVANTAGES

- Stainless Steel
- Suitable for FPO ballasted roofing systems

APPEARANCE / COLOR

Surface:

- Smooth

Top surface:

- Stainless steel

TECHNICAL INFORMATION

Height: 60 / 100 mm
 Length: 3000 mm
 Width: 30 mm

Sarnafil® T Gravelstop bracket

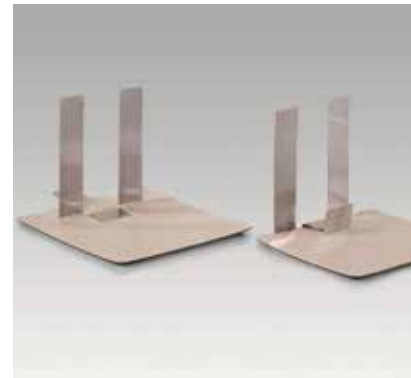

DESCRIPTION

Sarnafil® T Gravelstop bracket is a prefabricated bracket to fasten the S-Gravelstop Profile to Sarnafil® T (FPO) roof waterproofing membranes by heat welding and without penetrating the membrane.

USES

Sarnafil® T Gravelstop bracket may only be used by experienced professionals:

- Fastening the S-Gravelstop Profile to Sarnafil® T (FPO) roof waterproofing membranes with slopes of < 5°

CHARACTERISTICS / ADVANTAGES

- Sarnafil® T FPO membrane on corrosion resistant stainless steel bracket
- Suitable for ballasted roofing systems
- Easy application without penetrating the membrane
- Hot air weldable

APPEARANCE / COLOR

Top surface:

Membrane:

- Beige

Top surface:

Bracket:

- Stainless steel

TECHNICAL INFORMATION

Outside Bracket / Inside Bracket
 Length: 150 mm / 120 mm
 Width: 140 mm / 140 mm
 Height: 120 mm / 120 mm

SikaRoof® Cable Duct-110



DESCRIPTION

SikaRoof® Cable Duct-110 is a PE-HD prefabricated pipe bend with sliding socket and protection lid.

USES

This product may only be used by experienced professionals:

- Provides a watertight cable bushing detail on exposed roofs

CHARACTERISTICS / ADVANTAGES

- Constructed of durable PE-HD
- Proven waterproofing detail
- Easily connected over roof penetration

APPEARANCE / COLOR

Top surface:

Pipe bend with sliding socket:

- Black

TECHNICAL INFORMATION

Dimension pipe diameter: 110 mm

Paving support Pad / levelling shim



DESCRIPTION

Paving support Pad / levelling shim is a prefabricated high density polyethylene (HD-PE) paving support pad manufactured by injection moulding. It enables the correct positioning of paving slabs and provides water drainage between and underneath the slabs.

USES

Paving support Pad / levelling shim may only be used by experienced professionals:

- Placement of paving slabs on flat roofs, plaza decks, balconies, verandas, courtyards, terraces etc.

CHARACTERISTICS / ADVANTAGES

- Ease of application
- Resistant to UV exposure
- Correctly positions paving slabs
- Securely holds paving slabs in place
- Uniform spacing between paving slabs
- Very good water drainage between slabs and below the paving level
- Paving not fixed, allowing slabs to be removed easily

APPEARANCE / COLOR

Top surface:

- Black

TECHNICAL INFORMATION

Paving support pad 1/20 with cross:
 Joints
 Length x width: 105 x 105 mm
 Thickness: 9.50 mm
 Height of lug: 20 mm
 Thickness of lug: 5.00 mm
 Length of cross lug: 58.50 mm

Paving levelling shim
 Length x width: 106 x 106 mm
 Thickness: 2.00 mm

ANCILLARY COMPONENTS

Snow guard holder galvanized



DESCRIPTION

Two-piece galvanized steel bracket for ¾ inch tubes, mounted in a row and evenly spaced horizontally. The bottom part (base plate) is fixed in the substructure. The upper part (sword) is screwed through the sealing in the base plate and receives pipes in the snow guard system with two holes arranged one above the other.

The snow guard holder consists of:

- Stainless steel base plate with safety nuts M8
- Galvanized or powder-coated snow catcher Sword
- Two seals NBR, 150 × 100 mm to be ordered separately

USES

Snow protection system with double pipe passage (drill holes) to protect against the sliding of snow masses on flat sloping roofs.

CHARACTERISTICS / ADVANTAGES

- For heavier snow loads
- Resistant to environmental influences

Snow guard stainless steel



DESCRIPTION

Two-piece stainless steel bracket for ¾ inch tubes or 1 inch tubes mounted in a row and evenly spaced horizontally. The lower part (base plate) is fixed in the substructure. The upper part (sword) is screwed together by the seal in the base plate and accommodates pipes in the snow guard system with two holes arranged one above the other.

The snow guard consists of:

- Base plate with safety nuts M8
- Snow catcher sword
- Two seals NBR, 90 × 50 mm to be ordered separately

USES

Snow protection system with double pipe passage (drill holes) to protect against the sliding of snow masses on flat sloping roofs.

CHARACTERISTICS / ADVANTAGES

- Light weight
- Resistant to environmental influences



Sarnafil® T ACCESSORIES

WALKWAYS

Sarnafil® T Walkway Pad



DESCRIPTION

Sarnafil® T Walkway Pad is made of premium-quality flexible polyolefin (FPO) by injection moulding procedure.

USES

Sarnafil® T Walkway Pad is used:

- To provide a durable slip resisting walkway for roof maintenance or access on any Sarnafil® T roofing system

CHARACTERISTICS / ADVANTAGES

- Resistant to UV exposure
- Slip resistant surface
- Hot air weldable
- Rainwater drainage from beneath the Sarnafil® T
- Walkway Pad is provided by a network of moulded channels

APPEARANCE / COLOR

Surface:

- Chevron pattern with an alternating rib height of the embossing

Top surface:

- Dark grey

TECHNICAL INFORMATION

Length: 600 mm
 Width: 600 mm without welding tabs
 Thickness: 9.30 mm Including 3/5 mm non slip chevron pattern embossing

Sarnafil® TG-20 WW

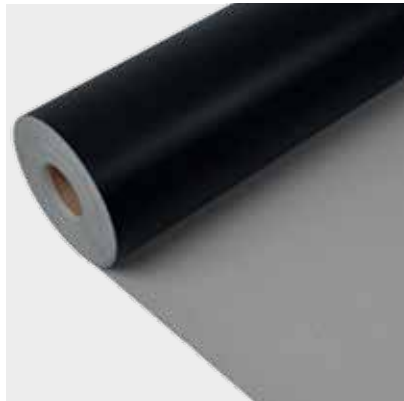

DESCRIPTION

Sarnafil® TG-20 WW is a protection sheet based on flexible polyolefins (FPO) with inlay of glass non-woven containing ultraviolet light stabilizers and flame retardant.

USES

■ Sarnafil® TG-20 WW is used as a protection layer on top of Sarnafil® T roof waterproofing membrane without ballast as a frequent walkway for roof maintenance.

CHARACTERISTICS / ADVANTAGES

- Applicable for exposed roofing
- Ease of application
- Hot air weldable

APPEARANCE / COLOR

Surface:

- Texturized

Top surface:

- Grey (~ RAL 7040)

Bottom surface:

- Dark grey

TECHNICAL INFORMATION

Length: 20.00 m
 Width: 0.66 m
 Thickness: 2.00 mm (incl. embossing)
 0.30 mm (depth of embossing)

Sarnafil® T ACCESSORIES

CONNECTION SYSTEM

Sarnafil® T Dilatec® ER-300



DESCRIPTION

Sarnafil® T Dilatec® ER-300 is a flexible, multi-layer, flexible polyolefin (FPO), sealing tape containing stabilisers, a glass fleece non-woven inlay and a single-sided fabric strip. It is bonded on one side with Sikadur Combiflex® CF Adhesive Normal or Rapid and welded on the other side (without fabric strip) to the Sarnafil® T roof waterproofing membrane.

USES

Sarnafil® T Dilatec® ER-300 may only be used by experienced professionals:

- End tape for Sarnafil® T roof waterproofing membranes on concrete and metal substrates

CHARACTERISTICS / ADVANTAGES

- Resistant to UV exposure
- High dimensional stability from glass fleece inlay
- Resistance to all common environmental influences
- Heat weldable
- No open flame equipment required

Sikadur Combiflex® CF Adhesive Normal / Rapid



DESCRIPTION

Sikadur Combiflex® CF Adhesive Normal / Rapid is a 2-part epoxy based thixotropic adhesive for bonding the modified flexible Polyolefin (FPO) waterproofing tapes Sarnafil T Dilatec® ER-300 to different substrates. Internal and external use.

USES

Adhesive for the Sarnafil T Dilatec® ER-300 system.

CHARACTERISTICS / ADVANTAGES

- Easy to mix and apply
- Excellent adhesion to many materials
- Performs well within a wide temperature range
- Good resistance to many chemicals
- No primer needed
- High mechanical resistance

APPLICATION TEMPERATURE

Normal: +10°C to +30°C
 Rapid: +5°C to +15°C



FASTENING PRODUCTS

Sarnafast® Washer KTL



DESCRIPTION

Zinc plated steel washer with diamond-shaped reinforcement and specially stamped bars for the mechanical fastening of roof waterproofing membranes.

USES

Mechanically fastened roof waterproofing membranes by Sarnafast® spot fastening in overlaps and / or intermediate spot fastening in combination with Sarnafast® Fastener SBF-6.0 on all decks. Only for fastening roof waterproofing membranes over compressible thermal insulation (not for use on hard substrates).

CHARACTERISTICS / ADVANTAGES

- Lightweight
- Resistance against common environmental influences
- Easy application in use with recommended setting tools
- Recyclable

TECHNICAL INFORMATION

Dimension: 82 × 40 mm
 Hole diameter: 7.50 mm
 Thickness: 1.00 mm
 Corrosion resistance: 15 cycles according to Kesternich

Sarnafast® Washer KT



DESCRIPTION

Zinc plated steel washer with diamond-shaped reinforcement and specially stamped bars for the mechanical fastening of roof waterproofing membranes.

USES

Mechanically fastened roof waterproofing membranes by Sarnafast® spot fastening in overlaps and / or intermediate spot fastening in combination with Sarnafast® Fastener SF-4.8 into corrugated steel and plywood / OSB decks. Only for fastening roof waterproofing membranes over compressible thermal insulation (not for use on hard substrates).

CHARACTERISTICS / ADVANTAGES

- Lightweight
- Resistance against common environmental influences
- Easy application in use with recommended setting tools
- Recyclable

TECHNICAL INFORMATION

Dimension: 82 × 40 mm
 Hole diameter: 4.90 mm
 Thickness: 1.00 mm
 Corrosion resistance: 15 cycles according to Kesternich

Sarnafast® Washer IF/IG-C



DESCRIPTION

Zinc plated steel washer for the mechanical fastening of roof waterproofing membranes.

USES

Mechanically fastened roof waterproofing membranes by Sarnafast® spot fastening in overlaps and / or intermediate spot fastening in combination with Sarnafast® Fastener SF-4.8 into corrugated steel and plywood / OSB decks or Sarnafast® Fastener SBF-6.0 on all decks. Only for fastening roof waterproofing membranes over hard substrates.

CHARACTERISTICS / ADVANTAGES

- Lightweight
- Resistance against common environmental influences
- Easy application in use with recommended setting tools
- Recyclable

TECHNICAL INFORMATION

Dimension: 82 × 40 mm
 Hole diameter: 7.50 mm
 Thickness: 1.00 mm
 Corrosion resistance: 15 cycles according to Kesternich

FASTENING PRODUCTS

Sarnafast® Tube SFT-50



DESCRIPTION

Polyamide tube (PA 6) with teeth for the mechanical fastening of roof waterproofing membranes and thermal insulation.

USES

Mechanically fastened roof waterproofing membranes by Sarnafast® spot fastening in overlaps and / or intermediate spot fastening in combination with Sarnafast® Fastener SBF-6.0 on all decks. Only for fastening roof waterproofing membranes over compressible thermal insulation (not for use on hard substrates). Further for the mechanical fastening of thermal insulation boards.

CHARACTERISTICS / ADVANTAGES

- Lightweight
- Resistance against common environmental influences
- Easy application in use with recommended setting tools
- Recyclable

TECHNICAL INFORMATION

Diameter: 55 mm (at collar)
 Available lengths: 40 – 230 mm
 Hole diameter: 13 mm
 Corrosion resistance: 30 h conditioned in conditioning cell

Sarnafast® Insulation Washer DTL



DESCRIPTION

Zinc plated steel washer for the mechanical fastening of thermal insulation.

USES

Mechanically fastened thermal insulation in combination with Sarnafast® Fastener SBF-6.0 on all decks.

CHARACTERISTICS / ADVANTAGES

- Lightweight
- Resistance against common environmental influences
- Easy application in use with recommended setting tools
- Recyclable

TECHNICAL INFORMATION

Dimension: 70 x 70 mm
 Hole diameter: 7.50 mm
 Thickness: 1.00 mm
 Corrosion resistance: 15 cycles according to Kesternich

Sarnafast® Insulation Washer DT



DESCRIPTION

Zinc plated steel washer for the mechanical fastening of thermal insulation.

USES

Mechanically fastened thermal insulation in combination with Sarnafast® Fastener SF-4.8 on corrugated steel and plywood / OSB decks.

CHARACTERISTICS / ADVANTAGES

- Lightweight
- Resistance against common environmental influences
- Easy application in use with recommended setting tools
- Recyclable

TECHNICAL INFORMATION

Dimension: 70 x 70 mm
 Hole diameter: 4.90 mm
 Thickness: 1.00 mm
 Corrosion resistance: 15 cycles according to Kesternich

Sarnabar® Fastening Profiles



DESCRIPTION

Folded profile hot-dip coated steel for the perimeter fastening.

USES

Perimeter fastening system in combination with Sarnafast® SF 4.8 into corrugated steel and plywood / OSB decks or Sarnafast® SBF-6.0 on all decks. Also with specific Sarnabar® Fastening Profile 6/15, Sarnabar® Tube SBT-20 and Sarnafast® SBF-6.0 on all decks.

CHARACTERISTICS / ADVANTAGES

- Lightweight
- Resistance against common environmental influences
- Easy application in use with recommended setting tools
- Recyclable

TECHNICAL INFORMATION

Length: 2250 / 4500 mm
 Width: 30 mm
 Height: 7 mm
 Hole diameter: 6.50 / 10 / 15 mm
 Thickness: 1.50 mm
 Corrosion resistance: 15 cycles according to Kesternich

Sarnabar® Tube SBT-20



DESCRIPTION

Polyamide tube (PA 6) for the perimeter fastening.

USES

Tube perimeter fastening and induction welding system in combination with Sarnabar® Fastening Profile 6/15 or SikaRoof® Induction Welding Disc FPO 16.0 and Sarnafast® Fastener SBF-6.0 on all decks.

CHARACTERISTICS / ADVANTAGES

- High resistance against mechanical inputs
- Lightweight
- Resistance against common environmental influences
- Easy application in use with recommended setting tools
- Recyclable

TECHNICAL INFORMATION

Diameter: 20 mm (at collar)
 Hole diameter: 12.40 mm
 Available lengths: 40 – 400 mm
 Corrosion resistance: 30 h conditioned in conditioning cell

Universal Row / Load Distribution Plate



DESCRIPTION

Polyamide (PA 6) plate for the row termination in intermediate fastening of mechanically fastened roof system – spot fastening.

USES

The Universal Row / Load Distribution Plate is applied at the end of intermediate spot fastening of mechanically fastened roof system to absorb the concentrated wind uplift forces. This reduces the load peaks and therefore possible damages on the roof waterproofing membrane. The plate to be fastened

with at least two Sarnafast® SF 4.8 into corrugated steel and plywood / OSB decks or at least two Sarnafast® SBF-6.0 on all decks and also with at least two Sarnabar® Tubes SBT-20 combined with two Sarnafast® SBF-6.0 on all decks.

CHARACTERISTICS / ADVANTAGES

- Usable with Sarnafast® Fastener and Sarnabar® Tubes
- High mechanical resistance

TECHNICAL INFORMATION

Diameter: 120 mm
 Hole diameter: 6 and 16 mm

FASTENING PRODUCTS

Sarnabar® Connection Clip



DESCRIPTION

Polyamide clip (PA 6).

USES

Connecting of standard Sarnabar® Fastening Profiles.

CHARACTERISTICS / ADVANTAGES

- Wasy and fast connection of the Sarnabar® Fastening Profiles
- 3 in 1 product (connection, protection and spacer)
- Easy application due to click function
- Makes use of a butt strap obsolete

TECHNICAL INFORMATION

Width: 34.50 mm
Length: 80 mm
Height: 11 mm

Sarnafil® T Welding Cord



DESCRIPTION

Cord made of FPO compound by extruding procedure.

USES

In combination with Sarnabar® Fastening Profiles preventing the membranes from slipping.

CHARACTERISTICS / ADVANTAGES

- Hot air weldable
- Recyclable

TECHNICAL INFORMATION

Diameter: 4.00 mm
Length: 150 m

Sarnafast® Fastener SBF-6.0



DESCRIPTION

Hardened carbon steel fastener.

USES

Fastener in combination with Sarnafast® Washer KTL, IF/G-C, Universal Row / Load Distribution Plate, Sarnafast® Insulation Washer DTL, Sarnafast® Tube SFT-50, SikaRoof® Induction Welding Disc FPO 6.8 and SikaRoof® Induction Welding Disc FPO 16.0 with Sarnabar® Tube SBT-20 into corrugated steel, concrete and plywood / OSB decks.

CHARACTERISTICS / ADVANTAGES

- Resistance against common environmental influences
- Easy application in use with recommended setting tools
- Self drilling fastener, no pre-drilling for steel and plywood / OSB applications
- Chrome VI-free
- Recyclable

TECHNICAL INFORMATION

Diameter: 6.00 mm
Head diameter: 9.80 mm
Available lengths: 35 - 300 mm
Drive: Torx T25
Corrosion resistance: 15 cycles according to Kesternich

Sarnafast® Fastener SF-4.8



DESCRIPTION

Hardened carbon steel fastener.

USES

Fastener in combination with Sarnafast® Washer KT, IF/G-C, Universal Row / Load Distribution Plate, Sarnafast® Insulation Washer DT and Sarnabar® Fastening Profiles into steel and plywood / OSB decks.

CHARACTERISTICS / ADVANTAGES

- Tread-fast solution
- Lightweight
- Resistance against common environmental influences
- Easy application in use with recommended setting tools
- Self-drilling fastener, no pre-drilling for steel application
- Chrome VI-free
- Recyclable

TECHNICAL INFORMATION

Diameter: 4.80 mm
Head diameter: 8.00 mm
Available lengths: 60 - 300 mm
80 - 300 mm (magazine loaded)
Drive: Hexagon head screw 8.00 mm
Corrosion resistance: 15 cycles according to Kesternich

Sarnafast® Fastener SF-M 4.8

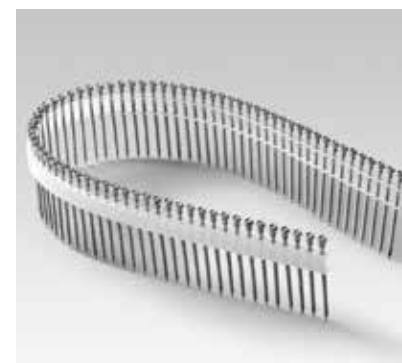

Also available in magazine loaded version Sarnafast Fastener SF-M 4.8 with automated setting tool.

FASTENING PRODUCTS – INDUCTION WELDING

SikaRoof® Induction Welding Disc FPO 6.8



DESCRIPTION

Zinc plated steel fastening discs with a green coloured hot melt adhesive coating for induction welding with Sarnafil® TS 77 roof waterproofing membranes.

USES

Mechanically field fastening of Sarnafil® TS 77 roof waterproofing membranes on thermal insulation or hard substrates by induction welding to the membrane in combination with Sarnafast® Fastener SBF 6.0 on all decks.

CHARACTERISTICS / ADVANTAGES

- Lightweight
- Resistant against all common environmental influences
- Ease of application in use with recommended tools and equipment
- Corrosion resistant
- Recyclable

TECHNICAL INFORMATION

Dimension: 80 mm
Hole diameter: 6.80 mm
Steel thickness: 0.80 mm
Corrosion resistance:
15 cycles according to Kesternich

SikaRoof® Induction Welding Disc FPO 16.0



DESCRIPTION

Zinc plated steel fastening discs with a green coloured hot melt adhesive coating for induction welding with Sarnafil® TS 77 roof waterproofing membranes.

USES

Mechanically field fastening of Sarnafil® TS 77 roof waterproofing membranes only over compressible thermal insulation (not for use on hard substrates) by induction welding to the membrane in combination with Sarnafast® Fastener SBF 6.0 and Sarnabar® Tube SBT-20 on all decks.

CHARACTERISTICS / ADVANTAGES

- Lightweight
- Resistant against all common environmental influences
- Ease of application in use with recommended tools and equipment
- Corrosion resistant
- Recyclable

TECHNICAL INFORMATION

Dimension: 80 mm
Hole diameter: 15.20 mm
Steel thickness: 0.80 mm
Corrosion resistance:
15 cycles according to Kesternich

SikaRoof® Induction Cardboard Pad



DESCRIPTION

Cardboard pad.

USES

SikaRoof® Induction Cardboard Pad must be used on top of EPS / XPS thermal insulation directly placed under SikaRoof® Induction Welding Disc FPO 6.8 or 16.0. Preventing the thermal insulation from melting during the induction welding process.

isoweld® 3000*



USES

User-friendly and ergonomic stand-up induction welding tool for use with the SikaRoof® field fastening system for induction welding of the Sarnafil® TS 77 roof waterproofing membranes to the SikaRoof® Induction Welding Disc

FPO 6.8 or 16.0. Integrated safety and security features, such as search and control functions, temperature and power compensation, quick and simple calibration process, ensuring proper and correct welds.

Hand inductor FI-H*



USES

Hand inductor welding tool for use with the SikaRoof® field fastening system for welding Sarnafil® TS 77 roof waterproofing membranes to the SikaRoof®

Induction Welding Disc FPO 6.8 or 16.0 in narrow and tight roof spaces and on vertical areas.

Magnets FI-Magnet*



USES

Magnetic heatsink for use with the SikaRoof® field fastening system. Positioned on the Sarnafil® TS 77 roof waterproofing membranes over the SikaRoof® Induction Welding Disc FPO 6.8 or 16.0 to apply pressure and to dissipate heat.

Extension rods included for working in an up-right position. The length of the rod can be reduced for better access in tight areas.

*Supplied by local SFS sales organization www.sfs.com



FASTENING PRODUCTS – COMBINATIONS

SPOT- / INTERMEDIATE AND PERIMETER FASTENING SYSTEMS

Metal Fastening Systems			Metal Fastening Systems		
Deck type	Corrugated steel deck		Concrete deck	Plywood / OSB deck	
Insulation fastening	Sarnafast® Insulation Washer DT Sarnafast® Fastener SF-4.8	Sarnafast® Insulation Washer DTL Sarnafast® Fastener SBF-6.0	Sarnafast® Insulation Washer DTL Sarnafast® Fastener SBF-6.0	Sarnafast® Insulation Washer DT Sarnafast® Fastener SF-4.8	Sarnafast® Insulation Washer DTL Sarnafast® Fastener SBF-6.0
Membrane fastening on soft substrates	Sarnafast® Washer KT Sarnafast® Fastener SF-4.8	Sarnafast® Washer KTL Sarnafast® Fastener SBF-6.0	Sarnafast® Washer KTL Sarnafast® Fastener SBF-6.0	Sarnafast® Washer KT Sarnafast® Fastener SF-4.8	Sarnafast® Washer KTL Sarnafast® Fastener SBF-6.0
Membrane fastening on hard substrates	Sarnafast® Washer IF/IG-C Sarnafast® Fastener SF-4.8	Sarnafast® Washer IF/IG-C Sarnafast® Fastener SBF-6.0	Sarnafast® Washer IF/IG-C Sarnafast® Fastener SBF-6.0	Sarnafast® Washer IF/IG-C Sarnafast® Fastener SF-4.8	Sarnafast® Washer IF/IG-C Sarnafast® Fastener SBF-6.0
Perimeter fastening	Sarnabar® Fastening Profile Sarnafast® Fastener SF-4.8	Sarnabar® Fastening Profile Sarnafast® Fastener SBF-6.0	Sarnabar® Fastening Profile Sarnafast® Fastener SBF-6.0	Sarnabar® Fastening Profile Sarnafast® Fastener SF-4.8	Sarnabar® Fastening Profile Sarnafast® Fastener SBF-6.0
Tube Fastening Systems			Tube Fastening Systems		
Insulation fastening	Sarnafast® Tube SFT-50 Sarnafast® Fastener SBF-6.0		Sarnafast® Tube SFT-50 Sarnafast® Fastener SBF-6.0	Sarnafast® Tube SFT-50 Sarnafast® Fastener SBF-6.0	
Membrane fastening	Sarnafast® Tube SFT-50 Sarnafast® Fastener SBF-6.0		Sarnafast® Tube SFT-50 Sarnafast® Fastener SBF-6.0	Sarnafast® Tube SFT-50 Sarnafast® Fastener SBF-6.0	
Perimeter fastening	Sarnabar® Fastening Profile Sarnabar® Tube SBT-20 Sarnafast® Fastener SBF-6.0		Sarnabar® Fastening Profile Sarnabar® Tube SBT-20 Sarnafast® Fastener SBF-6.0	Sarnabar® Fastening Profile Sarnabar® Tube SBT-20 Sarnafast® Fastener SBF-6.0	

INDUCTION WELDING SYSTEMS











Metal Fastening Systems			Metal Fastening Systems		
Deck type	Corrugated steel deck		Concrete deck	Plywood / OSB deck	
Insulation and membrane fastening	SikaRoof® Induction Welding Disc FPO 6.8 Sarnafast® Fastener SBF-6.0		SikaRoof® Induction Welding Disc FPO 6.8 Sarnafast® Fastener SBF-6.0	SikaRoof® Induction Welding Disc FPO 6.8 Sarnafast® Fastener SBF-6.0	
Perimeter fastening with induction welding	SikaRoof® Induction Welding Disc FPO 6.8 Sarnafast® Fastener SBF-6.0		SikaRoof® Induction Welding Disc FPO 6.8 Sarnafast® Fastener SBF-6.0	SikaRoof® Induction Welding Disc FPO 6.8 Sarnafast® Fastener SBF-6.0	
Perimeter fastening with linear fastening	Sarnabar® Fastening Profile Sarnafast® Fastener SBF-6.0		Sarnabar® Fastening Profile Sarnafast® Fastener SBF-6.0	Sarnabar® Fastening Profile Sarnafast® Fastener SBF-6.0	
Tube Fastening Systems			Tube Fastening Systems		
Insulation and membrane fastening	SikaRoof® Induction Welding Disc FPO 16.0 Sarnabar® Tube SBT-20 Sarnafast® Fastener SBF-6.0		SikaRoof® Induction Welding Disc FPO 16.0 Sarnabar® Tube SBT-20 Sarnafast® Fastener SBF-6.0	SikaRoof® Induction Welding Disc FPO 16.0 Sarnabar® Tube SBT-20 Sarnafast® Fastener SBF-6.0	
Perimeter fastening with induction welding	SikaRoof® Induction Welding Disc FPO 16.0 Sarnabar® Tube SBT-20 Sarnafast® Fastener SBF-6.0		SikaRoof® Induction Welding Disc FPO 16.0 Sarnabar® Tube SBT-20 Sarnafast® Fastener SBF-6.0	SikaRoof® Induction Welding Disc FPO 16.0 Sarnabar® Tube SBT-20 Sarnafast® Fastener SBF-6.0	
Perimeter fastening with linear fastening	Sarnabar® Fastening Profile Sarnabar® Tube SBT-20 Sarnafast® Fastener SBF-6.0		Sarnabar® Fastening Profile Sarnabar® Tube SBT-20 Sarnafast® Fastener SBF-6.0	Sarnabar® Fastening Profile Sarnabar® Tube SBT-20 Sarnafast® Fastener SBF-6.0	

FASTENING PRODUCTS – TOOLS























SETTING- AND INSTALLATION TOOLS FOR FASTENING PRODUCTS*

	Product	Uses
		For the automated setting of magazine loaded Sarnafast® Fastener SF-M 4.8
	IF240-B	Automated setting tool for the fast and economic installation of fasteners and washers. For belted fasteners Sarnafast® Fastener SF-M 4.8 with washers Sarnafast® Washer IF/IG-C, KT and Sarnafast® Insulation Washer DT.

BITS AND ACCESSORIES FOR FASTENING PRODUCTS

	Product	Uses
		For the installation of Sarnafast® Fastener SBF-6.0 and Sarnafast® Fastener SF-4.8 inside Sarnabar® Tube SBT-20 or Sarnafast® Tube SFT-50
	T25-32-M6	Insert bit with T25 drive
	ZA1/4"-M6-300 / -750	Drive bar for installation of fasteners and tubes, length 300 and 750 mm
	ZA1/4"-M6-EXT100	Drive bar extension, length 100 mm
	ZH-12-RING	Adapter to hold Sarnabar® Tube SBT-20 and Sarnafast® Tube SFT-50 onto drive bar
	ZA 1/4"-DL	Helps to prevent pull-over failures and acts as a depth stop for pre-assembled tube / fastener combinations
	E320-1/4"-25	Socket for fastener with HEX 8 head
	E320-1/4"-25-M6	Connecting piece between E320 socket and drive bar
		For the manual installation of Sarnafast® Fastener SBF-6.0 with T25 drive
	T25-25-HEX1/4"	Insert bit with T25 drive and HEX shaft
	Bit holder ZA1/4"	Bit holder for bits with HEX shaft
		For the manual installation of Sarnafast® Fastener SF-4.8 with HEX 8 head
	E380-3/8"-34	Socket for fastener with HEX 8 head, for manual fastener installation
	ZA1/4"	Drive bar for socket, for manual fastener installation

DRILL BITS FOR FASTENING PRODUCTS*

	Product	Uses
		For the use in combination with Sarnabar® Tube SBT-20 and Sarnafast® Tube SFT-50 on concrete
	SDS-4,8	SDS drill bits – available in different lengths
	SDS-5,0	
	SDS-5,2	
	SDS-6,3	
		For the use in combination with Sarnabar® Tube SBT-20 and Sarnafast® Tube SFT-50 on concrete
	ZVK-4,8 x 100 x 160	Conus drill bits for combination with ZAK drill extension
	ZVK-5,0 x 55 x 115	
	ZVK-5,0 x 100 x 160	
	ZVK-5,2 x 100 x 160	Conus drill bits with stop function for combination with ZAK drill extension
	ZVK-4,8 x 100 x 165-STOP	
	ZVK-5,0 x 25 x 90-STOP	
	ZVK-5,0 x 35 x 100-STOP	
	ZVK-5,0 x 45 x 110-STOP	
	ZVK-5,0 x 55 x 120-STOP	
	ZVK-5,2 x 25 x 90-STOP	
	ZVK-5,2 x 35 x 100-STOP	
	ZVK-5,2 x 45 x 110-STOP	
	ZVK-5,2 x 100 x 165-STOP	
	ZAK-500	Drill extension for ZVK conus drill bits, length 500, 750 and 1000 mm
	ZAK-750	
	ZAK-1000	
		For the use in combination with Sarnabar® Tube SBT-20 and Sarnabar® Fastening Profiles, 15 mm hole
	ZAK-14-500	Drill extension for ZVK-14 conus drill bits with 14 mm outer diameter, length 500 mm
	ZVK-14-5,0 x 100 x 135	Conus drill bit for combination with ZAK-14 drill extension, with 14 mm outer diameter
	ZVK-14-5,0 x 45 x 80-STOP	Conus drill bit with stop function for combination with ZAK-14 drill extension with 14 mm outer diameter

*Supplied by local SFS sales organization www.sfs.com



ROOF DESIGN PRODUCTS

Sarnafil® T Decor Profile



DESCRIPTION

Sarnafil® T Decor Profile is an FPO extruded profile made which is welded to Sarnafil® T (FPO) sheet waterproofing membranes to replicate standing seam metal roofing systems.

USES

Sarnafil® T Decor Profile may only be used by experienced professionals:

- Creating an appearance of a standing seam metal roof

CHARACTERISTICS / ADVANTAGES

- Applicable for exposed roofing
- Ease of application
- Suitable for any roof slope
- Hot air weldable

APPEARANCE / COLOR

Surface:

- Smooth

Color:

- Window grey (~ RAL 7040)
- Anthracite (~ RAL 7016)
- Other colors on request

TECHNICAL INFORMATION

Length: 3000 mm

Width: 35 mm

Height: 25 mm

Sikagard®-950



DESCRIPTION

Sikagard®-950 is a 2-part, water-based, UV resistant, colored polyurethane-coating for Sarnafil® FPO roof waterproofing membranes.

USES

Sikagard®-950 may only be used by experienced professionals:

- Decorative coating for Sarnafil® FPO roof waterproofing membranes for:
- Flat and sloping fully exposed roof structures
- New roofs
- Roof refurbishment
- Roof graphics
- Architectural detailing
- Marking out safety zones

CHARACTERISTICS / ADVANTAGES

- Good opacity
- Resistant to UV exposure
- High flexibility
- Available in many colors
- Good mechanical properties
- PVC plasticiser blocking properties
- Easily cleanable
- Low surface soiling
- Easy application by brush, roller or airless spray

Sikalastic® Primer FPO



DESCRIPTION

Sikalastic® Primer FPO is an one-component, transparent, slightly yellowing, solvent-based synthetic polymer primer, specifically formulated to bond Sikagard®-950 onto FPO membranes.

USES

Sikalastic® Primer FPO may only be used by experienced professionals.

CHARACTERISTICS / ADVANTAGES

- One-component - easy and ready to use
- Enhance adhesion to Sarnafil® FPO Membranes
- Fast curing-overcoating possible after max 1 hour



SERVICE INFORMATION

PRODUCT INFORMATION

APPLICATION INSTRUCTIONS

STANDARD DETAILS

SUSTAINABLE SOLUTIONS

PRODUCT OVERVIEW FELTS AND GLASS FLEECE

Product	S-Felt A-300	Sikaplan® W Felt 500 PP	S-Felt S-800	S-Felt T-300	S-Glass Fleece-120	S-Felt VS-140	S-Felt GK-400
Function	Levelling- and Protection Layer	Levelling- and Protection Layer	Levelling- and Protection Layer	Separation-, Levelling- and Protection Layer	Separation- and Fire Protection Layer	Filter Layer	Protection- and Slip Layer
Properties							
Base material	Polypropylene (PP)	Polypropylene (PP)	Polypropylene (PP)	Polyester (PES)	Glass fibre	Polypropylene (PP)	Polypropylene with PE film (PP / PE)
Weight (g/m²)	300	500	800	300	120	140	400
Roll size (m)	2 x 50	2 x 25	2 x 25	2 x 50	2 x 100	2 x 50	2 x 50
Resistance							
UV irradiation				●			
Bitumen	●	●	●	●	●	●	●
Alkaline solutions (ph 12)	●	●	●	○		●	●
Heat (+60 °C)	●	●	●	●	●	●	●
Practical Application							
Bitumen new or aged	○	●	●	●●			○
PVC aged	●	●	●	●			○
Concrete	●	●	●				○
Inverted Roof System with XPS							
Filter Layer						●●	
Protection- and Slip Layer							●●

- Most suitable
- Suitable
- Conditionally suitable

LEVELLING- AND PROTECTION LAYERS

S-Felt A-300



DESCRIPTION

S-Felt A-300 is a levelling- and protection layer made of polypropylene (PP).

USES

Levelling layer between Sarnafil® T membranes and rough surfaces.

CHARACTERISTICS / ADVANTAGES

- Bitumen resistant
- Easily applied

APPEARANCE / COLOR

- Surface:
 ■ Structured
 Color:
 ■ Multi-colored
 Weight:
 ■ 300 g/m²

Sikaplan® W Felt 500 PP



DESCRIPTION

Sikaplan® W Felt 500 PP is a levelling- and protection layer made of polypropylene non woven fabric.

USES

Levelling layer between Sarnafil® T membranes and rough surfaces.

CHARACTERISTICS / ADVANTAGES

- Bitumen resistant
- Easily applied

APPEARANCE / COLOR

- Surface:
 ■ Structured
 Color:
 ■ Multi-colored
 Weight:
 ■ 500 g/m²

S-Felt S-800



DESCRIPTION

S-Felt S-800 is a levelling- and protection layer made of polypropylene (PP).

USES

Levelling layer between Sarnafil® T membranes and rough surfaces.

CHARACTERISTICS / ADVANTAGES

- Bitumen resistant
- Easily applied

APPEARANCE / COLOR

- Surface:
 ■ Structured
 Color:
 ■ Multi-colored
 Weight:
 ■ 800 g/m²

SEPARATION-, LEVELLING- AND PROTECTION LAYER

S-Felt T-300



DESCRIPTION

S-Felt T-300 is a separation-, levelling- and protection layer made of polyester (PES).

USES

S-Felt T-300 is used as a separation and levelling layer between Sarnafil® T membranes and incompatible substrates. S-Felt T-300 can also be used as a protection layer between Sarnafil® T membranes and any protective topping or pavement.

CHARACTERISTICS / ADVANTAGES

- Bitumen resistant
- Non decaying
- Suitable for mechanical fastening (drill proved)
- Recyclable

APPEARANCE / COLOR

- Surface:
- Structured
- Color:
- White

SEPARATION- AND FIRE PROTECTION LAYER

S-Glass Fleece-120



DESCRIPTION

S-Glass Fleece-120 is a glass fibre separation- and fire protection layer.

USES

Separation and fire protection layer between Sarnafil® T membranes and EPS / XPS insulation.

CHARACTERISTICS / ADVANTAGES

- Easily applied

APPEARANCE / COLOR

- Surface:
- Structured
- Color:
- White

FILTER LAYER

S-Felt VS-140



DESCRIPTION

S-Felt VS-140 is a filter layer made of polypropylene (PP)

USES

Filter layer in inverted roofs systems to prevent small particles from penetrating gaps and voids in the thermal insulation layer.

CHARACTERISTICS / ADVANTAGES

- Bitumen resistant
- Alkali resistant (pH 11,6)
- Ease of application

APPEARANCE / COLOR

Surface:

- Structured
- Color:
- Grey

PROTECTION- AND SLIP LAYER

S-Felt GK-400



DESCRIPTION

S-Felt GK-400 is a protection and slip layer made of polypropylene (PP) with a polyethylene (PE) coating on one side.

USES

Protection and slip layer beneath paving or poured cementitious toppings.

CHARACTERISTICS / ADVANTAGES

- Bitumen resistant
- Acids resistant (pH 2,4)
- Easily applied

APPEARANCE / COLOR

Surface:

- Structured and smooth
- Color:
- Multi-colored/black

PROTECTION LAYERS

Sarnafil® TG 63

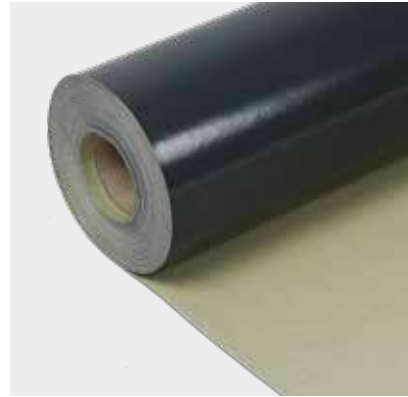

DESCRIPTION

Sarnafil® TG 63 is a protection sheet based on flexible polyolefins (FPO) with a glass non-woven flame retardant inlay.

USES

Protection layer on top of Sarnafil® T roof waterproofing membranes for ballasted flat roof systems.

CHARACTERISTICS / ADVANTAGES

- Hot air weldable
- Good mechanical strength

APPEARANCE / COLOR

Surface:

- Smooth
- Greenish
- Anthracite

Bottom surface:

- Dark grey

TECHNICAL INFORMATION

Length: 25.00 / 15.00 / 10.00 m
Width: 2.00 m
Thickness: 1.30 / 2.00 / 2.50 mm

S-Protection Sheet RS



DESCRIPTION

S-Protection Sheet RS is made of technical-grade recycled rubber granulate, polyurethane-bonded.

USES

S-Protection Sheet RS is a versatile protection layer on flat roofs and building structures.

CHARACTERISTICS / ADVANTAGES

- Easy to install
- High compressive strength
- Extremely rugged and durable
- Rot-resistant
- Recyclable

APPEARANCE / COLOR

Surface:

- Grain-textured
- Top surface:
- Black with multicolored speckles

TECHNICAL INFORMATION

Length: 10.00 / 8.00 m
Width: 1.25 m
Thickness: 6.00 / 8.00 mm

PROTECTION-, DRAINAGE- AND FILTER LAYERS

Aquadrain 550



DESCRIPTION

Aquadrain 550 is made of mechanically strengthened Polypropylene (PP) fibres.

USES

Aquadrain 550 is used as drainage, water retention and protection layer for extensive and intensive green roof systems with a minimal slope of 1.50%.

CHARACTERISTICS / ADVANTAGES

- 3 in 1 product (drainage, water retention and protection)
- Suitable for extensive and intensive green roofs with slopes of minimum 1.50%
- Ease of application
- Non decaying
- Not UV stable

APPEARANCE / COLOR

Surface:

- Structured

Color:

- Brown

SikaRoof® Drainage Layer 20L2F



DESCRIPTION

SikaRoof® Drainage Layer 20L2F comprises of a threedimensional composite polymer drainage core connected to a fleece filter (PP) on both sides.

USES

SikaRoof® Drainage Layer 20L2F may only be used by experienced professionals:
■ It is used as a drainage, filter and protection layer for flat roof extensive and intensive green roof systems

CHARACTERISTICS / ADVANTAGES

- 3 in 1 product (drainage, protection and filter layer)

APPEARANCE / COLOR

Color:

Drainage core

- Black
- Filter fleece
- Light grey

SYSTEM OVERVIEW SikaRoof® CONTROL / MONITORING SYSTEMS



Aspects such as sustainability and energy efficiency are becoming increasingly important in today's world. This development is based on a holistic view of a building in its entire life cycle. SikaRoof® Control / Monitoring Systems enable to inspect water ingress and detect / locate the defective area and help to secure material assets and prevent consequential damages. The continuous monitoring of the building condition allows for a targeted and cost-effective maintenance. The SikaRoof® Control / Monitoring is designed as a modular system.



Brochure:
SikaRoof® Control -
Monitoring / Leak
Detection Systems



Video:
The Smart Flat Roof -
SikaRoof® Monitoring
System

	Control Pipe - manual visual inspection possibility	Control Pipe - with integrated 24/7 monitoring	Compartments / Waterstop System	SikaRoof® Control (precise leak detection)
Detection of water on vapour- control layer / barrier	● (visual check / passive)	● (monitoring / active)	○	○
Limiting the area of water spread inside the roof build-up	○	○	● (100 - 600 m ² compartment size)	○
Precise leak detection possibility	○	○	○	● (high / low voltage test)

● Suitable
○ Not suitable

SikaRoof® CONTROL / MONITORING

CONTROL PIPE - MANUAL VISUAL INSPECTION POSSIBILITY

Enables inspecting any water ingress by visually inspecting the control pipe on the roof. The roof area is usually divided into compartments.

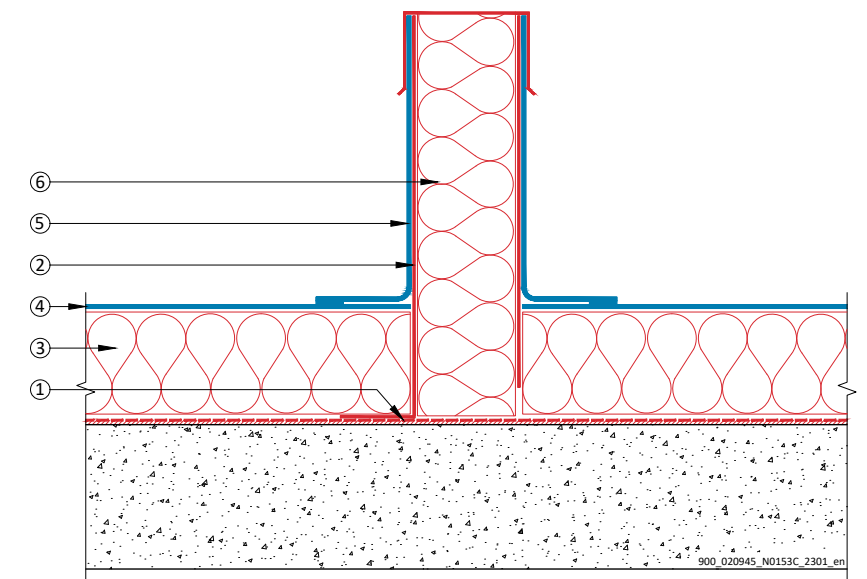

- 1 Vapour- control layer / barrier
- 2 Sarnafil® T Control Pipe
- 3 Thermal insulation
- 4 Sarnafil® T membrane
- 5 Prefabricated Sarnafil® T flashing
- 6 Cap with integrated insulation plug

CONTROL PIPE - WITH INTEGRATED 24/7 MONITORING

Permanent electronic roof monitoring in the control pipe with SikaRoof® Sensor Active R. The roof area is usually divided into compartments.

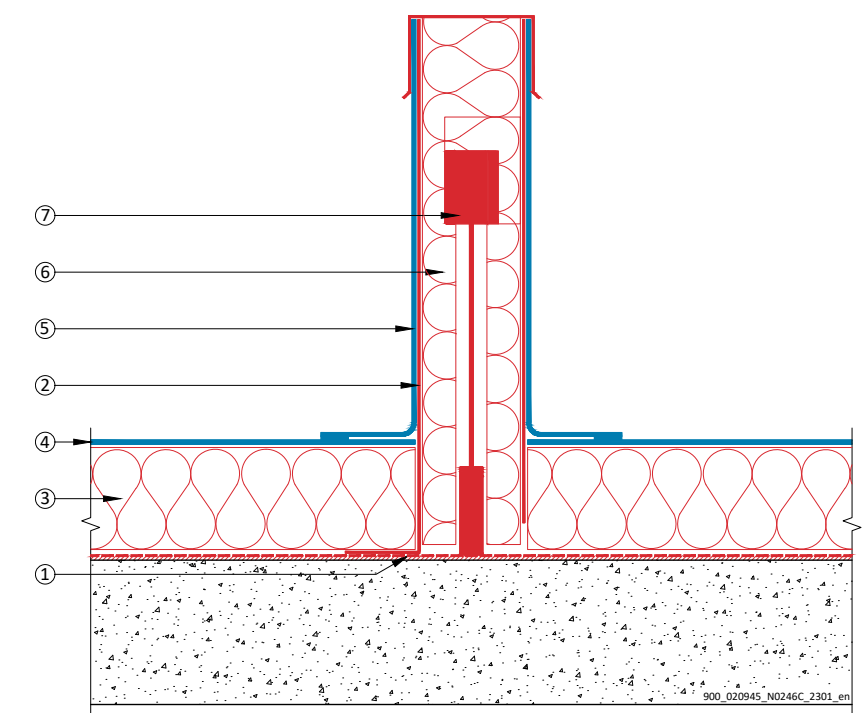

- 1 Vapour- control layer / barrier
- 2 Sarnafil® T Control Pipe
- 3 Thermal insulation
- 4 Sarnafil® T membrane
- 5 Prefabricated Sarnafil® T flashing
- 6 Cap with integrated insulation plug
- 7 SikaRoof® Sensor Active R

SikaRoof® CONTROL / MONITORING

CONTROL PIPE - WITH INTEGRATED LEAK DETECTION POSSIBILITY

Enables inspecting any water ingress by visually inspecting the control pipe on the roof and precise leak detection possibility.

The SikaRoof® Glass - Graphite Fleece (electrical conductive) is applied below the roofing membrane on top of the thermal insulation.

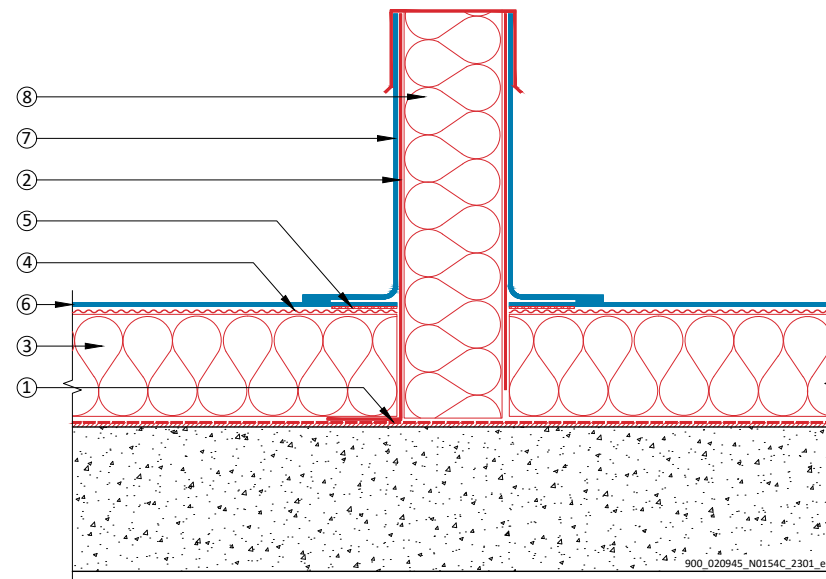

- | | |
|-------------------------------------|---------------------------------------|
| 1 Vapour- control layer / barrier | 5 SikaRoof® Control Contact Plate |
| 2 Sarnafil® T Control Pipe | 6 Sarnafil® T membrane |
| 3 Thermal insulation | 7 Prefabricated Sarnafil® T flashing |
| 4 SikaRoof® Glass - Graphite Fleece | 8 Cap with integrated insulation plug |

CONTROL PIPE - WITH INTEGRATED 24/7 MONITORING AND LEAK DETECTION POSSIBILITY

Permanent electronic roof monitoring in the control pipe with SikaRoof® Sensor Active R and precise leak detection possibility.

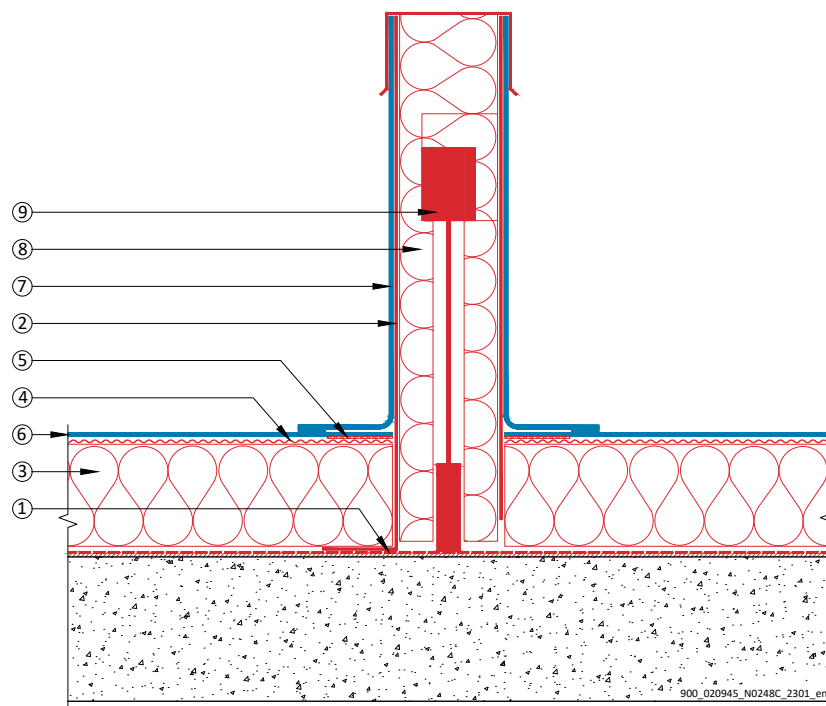

- | | |
|-------------------------------------|---------------------------------------|
| 1 Vapour- control layer / barrier | 6 Sarnafil® T membrane |
| 2 Sarnafil® T Control Pipe | 7 Prefabricated Sarnafil® T flashing |
| 3 Thermal insulation | 8 Cap with integrated insulation plug |
| 4 SikaRoof® Glass - Graphite Fleece | 9 SikaRoof® Sensor Active R |
| 5 SikaRoof® Control Contact Plate | |

SikaRoof® TERRACE MONITORING / CONTROL

ROOF TERRACE - WITH INTEGRATED 24/7 MONITORING

Permanent electronic roof monitoring in the SikaRoof® XPS insulation core and lid with SikaRoof® Sensor Active T. The roof area is usually divided into compartments.

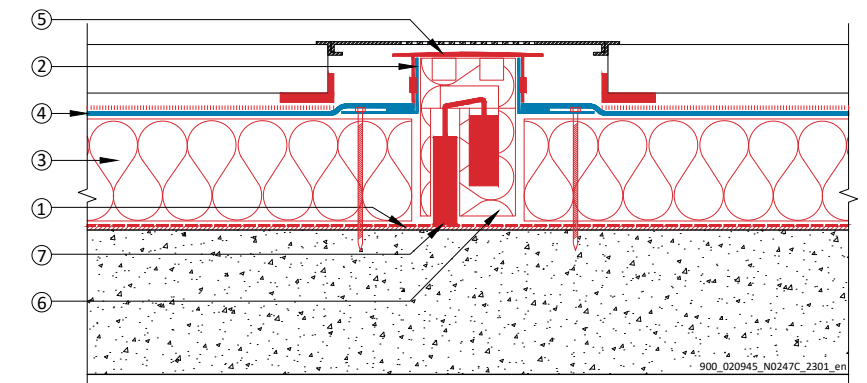

- | | |
|-----------------------------------|---------------------------------|
| 1 Vapour- control layer / barrier | 5 Lid with rubber seal |
| 2 Sarnafil® T Drain | 6 SikaRoof® XPS insulation core |
| 3 Thermal insulation | 7 SikaRoof® Sensor Active T |
| 4 Sarnafil® T membrane | |

ROOF TERRACE - WITH INTEGRATED 24/7 MONITORING AND LEAK DETECTION POSSIBILITY

Permanent electronic roof monitoring in the SikaRoof® XPS insulation core and Lid with SikaRoof® Sensor Active T and precise leak detection possibility.

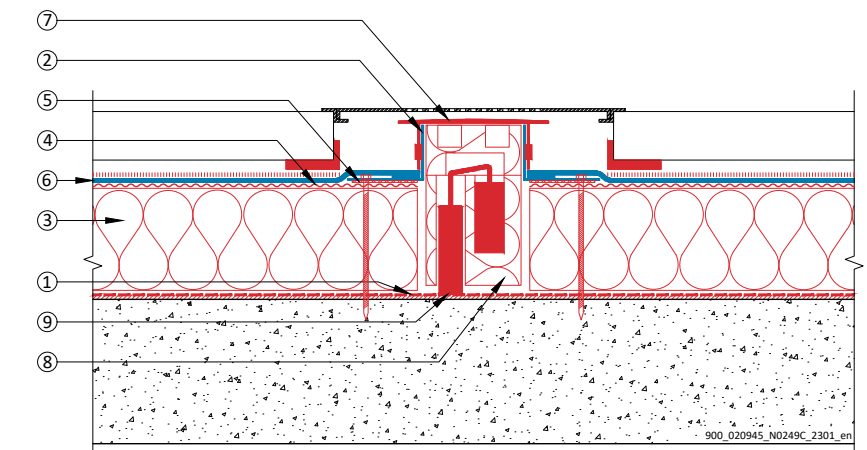

- | | |
|-------------------------------------|---------------------------------|
| 1 Vapour- control layer / barrier | 6 Sarnafil® T membrane |
| 2 Sarnafil® T Drain | 7 Lid with rubber seal |
| 3 Thermal insulation | 8 SikaRoof® XPS insulation core |
| 4 SikaRoof® Glass - Graphite Fleece | 9 SikaRoof® Sensor Active T |
| 5 SikaRoof® Control Contact Plate | |

COMPARTMENTS / WATERSTOP SYSTEM

ROOF COMPARTMENTS WITH WATERSTOP SYSTEM

To achieve a compartment system, the roof area shall be divided into smaller areas of 100 m² up to 600 m², in order to limit the leaking area when the roof ever becomes damaged. The compartment is executed with the waterstop system.

Compartment size:

- 100 to 300 m² (if the protective layer is difficult to remove)
- 300 to 600 m² (if the protective layer is easy to remove)

The design and layout of the compartment system should be co-ordinated with roof valleys and the drainage system. Waterstops are typically positioned at high points and the control pipe at the low point of the roof. Each compartment needs to be provided with a control pipe. Waterstops form a watertight seal between the roofing membrane and the vapour-control layer / barrier in order to minimize water damage in case of a leak. Waterstops are important safety components. Besides subdividing roofs into smaller areas, they separate special zones from the rest of the roof. Waterstops are installed to divide the roof into compartments.

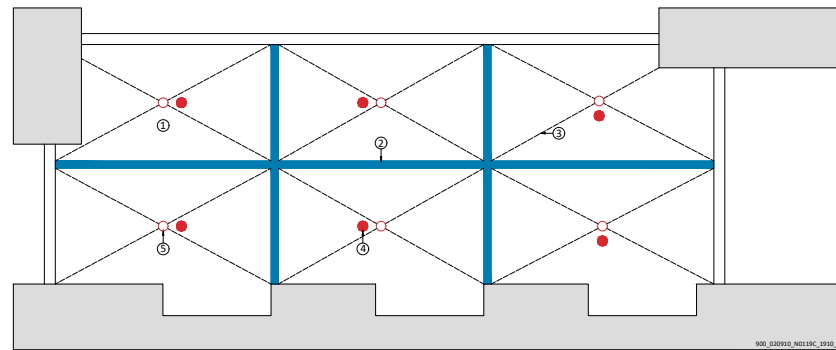

- 1 Compartment
- 2 Waterstop
- 3 Valley
- 4 Control pipe
- 5 Roof drain

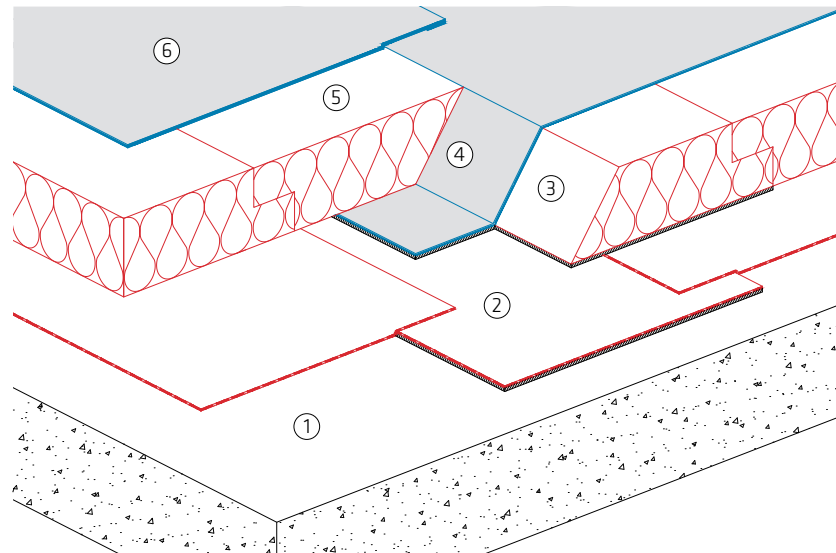

- 1 Roof deck
- 2 Bituminous vapour barrier, fully adhered at least in the area of partition
- 3 Thermal insulation layer – edge cut at 45° – adhered to serve as a stopper for the partition
- 4 Sarnafil® T membrane adhered with hot bitumen to the vapour barrier
- 5 Loose laid thermal insulation layer – edge cut 45°
- 6 Sarnafil® T membrane welded to the already installed membrane

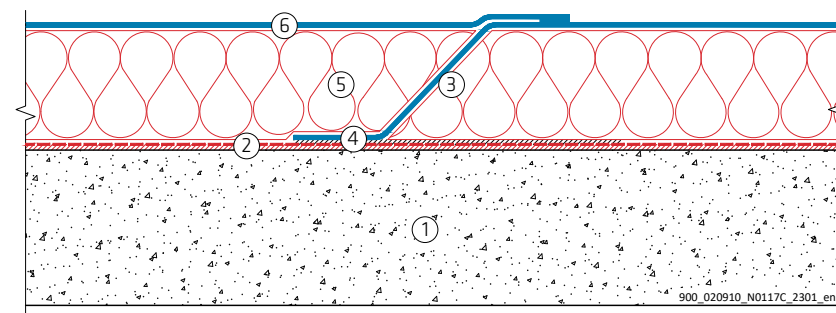

SikaRoof® CONTROL – LEAK DETECTION

SYSTEM FOR PRECISE LEAK DETECTION

The System is suitable for new construction and refurbishment projects. In the construction phase of the roof, the electrically conductive special glass / graphite fleece is installed below the roofing membrane on top of the thermal insulation. In order to carry out leak detection, two control pipes together with the stainless steel contact plate are installed every 1500 m². This gives an easy access point to the technician to connect the leak detection device.

Main advantages of the System:

- Possibility of simple leak-tests from the beginning
- Leak detection / tests can be conducted with the low and high voltage method
- Significant reduced costs due to target determination of the error sources

Low voltage leak detection



Low voltage leak detection requires only a thin film of water on the tested surface. The negative output of the generator is applied to the trace wire which borders the test area, whilst the positive output is connected to a suitable building substrate. If water has penetrated the roofing membrane within the test area, a current will flow from this source point, via the water on the roof towards the trace wire. The detector is used to identify the direction of electrical current and detect the point of origin (where water is penetrating the roofing membrane).

Note: The roof layers above the roofing membrane must be water-permeable. An electrically conductive layer is required below the roofing membrane.

High voltage leak detection



The earth lead from the high voltage test device is connected to a convenient earth point on the structure. A high voltage DC current is applied to the dry surface of the roofing membrane. When there are no faults present, the roofing membrane acts as an electrical insulator by stopping the flow of current out of the device. When the electrode passes a fault or hole, the high voltage jumps the gap between the electrode and the conductive layer below the roofing membrane, causing a current to flow. The audible and visual alarm of the testing device will alert the operator.

Note: The surface / roof membrane needs to be completely dry. An electrically conductive layer is required below the roofing membrane.

SikaRoof® CONTROL / MONITORING PRODUCTS

Sarnafil® T Sensor Control Pipe Set



DESCRIPTION

The Sarnafil® T Sensor Control Pipe Set comprises of 3 parts. A rigid high quality polypropylene (PP) pipe, an expanded polyethylene (EPE) insulation plug with cap and a prefabricated Sarnafil® T (FPO) flashing.

USES

Sarnafil® T Sensor Control Pipe Set may only be used by experienced professionals.

- The Sarnafil® T Sensor Control Pipe Set enables to house the SikaRoof® Sensor active R and provides an inspection point on the flat-rooftop to check / monitor the watertightness.

CHARACTERISTICS / ADVANTAGES

- Easily installed
- Suitable for new projects and retrofitting existing flat roofs

PACKAGING

The Sarnafil® T Sensor Control Pipe Set consists of:

- Pipe with base plate (one piece)
- Cap with integrated insulation plug
- Prefabricated Sarnafil® T flashing

SikaRoof® Sensor Active R / T



Active R – Roof / Active T – Terrace

DESCRIPTION

The SikaRoof® Sensor Active R / T is a battery powered, wireless sensor for water detection and monitoring the humidity in flat roof build-up.

USES

SikaRoof® Sensor Active R / T may only be used by experienced professionals.

- SikaRoof® Sensor Active R / T is used to detect water ingress and to monitor the humidity in flat roof build-up

CHARACTERISTICS / ADVANTAGES

- Radio based sensor system based on latest IoT-Net-work technology
- Easily installed, no electrician required on job-site
- Easily to start-up due to plug-and-play system
- Self-sufficient electric power supply with batteries
- Suitable for new construction, refurbishment and retrofitting

Sarnafil® T Drain

Please refer to [Sarnafil® T Drain](#) on page 56

SikaRoof® XPS insulation core and Lid



DESCRIPTION

SikaRoof® XPS insulation core and Lid made of polypropylene (PP) including rubber seal.

USES

Enables to monitor the terrace build-up in combination with the SikaRoof® Sensor Active T.



Sarnafil® T Control Pipe Set



DESCRIPTION

The Sarnafil® T Control Pipe Set is made of rigid high quality polypropylene (PP) pipe and cap, expanded polyethylene (EPE) insulation plug and prefabricated Sarnafil® T (FPO) flashing.

USES

The Sarnafil® T Control Pipe Set enables to check the watertightness of a flatroof from the rooftop.

CHARACTERISTICS / ADVANTAGES

- Resistant to UV exposure
- Ease of application

PACKAGING

The Sarnafil® T Control Pipe Set consists of:

- Pipe with base plate (one piece)
- Cap with integrated insulation plug
- Prefabricated Sarnafil® T flashing

SikaRoof® Glass – Graphite Fleece



DESCRIPTION

SikaRoof® Glass – Graphite Fleece is a conductive and fire protection layer made of non-woven glass fibre.

USES

SikaRoof® Glass – Graphite Fleece may only be used by experienced professionals.

- SikaRoof® Glass – Graphite Fleece is used as a conductive layer to facilitate leak detection below Sarnafil® T roofing membranes.

CHARACTERISTICS / ADVANTAGES

- Easily applied
- Suitable for mechanically fastened and ballasted roof systems

TECHNICAL INFORMATION

Roll dimension: 2 x 50 m
Weight: 120 g/m²

SikaRoof® Stainless Steel Mesh



DESCRIPTION

SikaRoof® Stainless Steel Mesh is an electrically conductive stainless steel mesh.

USES

SikaRoof® Stainless Steel Mesh may only be used by experienced professionals. SikaRoof® Stainless Steel Mesh is used as a conductive layer to facilitate leak detection below adhered Sarnafil® roofing membranes.

CHARACTERISTICS / ADVANTAGES

- Highly electrically conductive
- Easily applied
- Corrosion resistant
- Not flammable
- Suitable for adhered roof systems

TECHNICAL INFORMATION

Roll dimension: 1.50 x 40 m
Weight: 87 g/m²

SikaRoof® Control Contact Plate

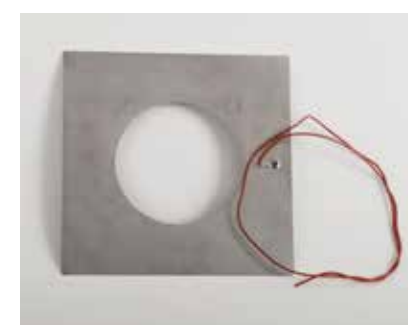

DESCRIPTION

The SikaRoof® Control Contact Plate is a stainless steel plate to connect the applied conductive glass felt with the read-out device.

USES

SikaRoof® Control Contact Plate may only be used by experienced professionals.

- Contact plate between the applied conductive glass felt and the read-out device.

CHARACTERISTICS / ADVANTAGES

- Easy application without the use of fasteners
- Plate includes the the 800 mm long connection wire

SikaRoof® CONTROL / MONITORING SYSTEMS

SikaRoof® Sensor Data Transmission

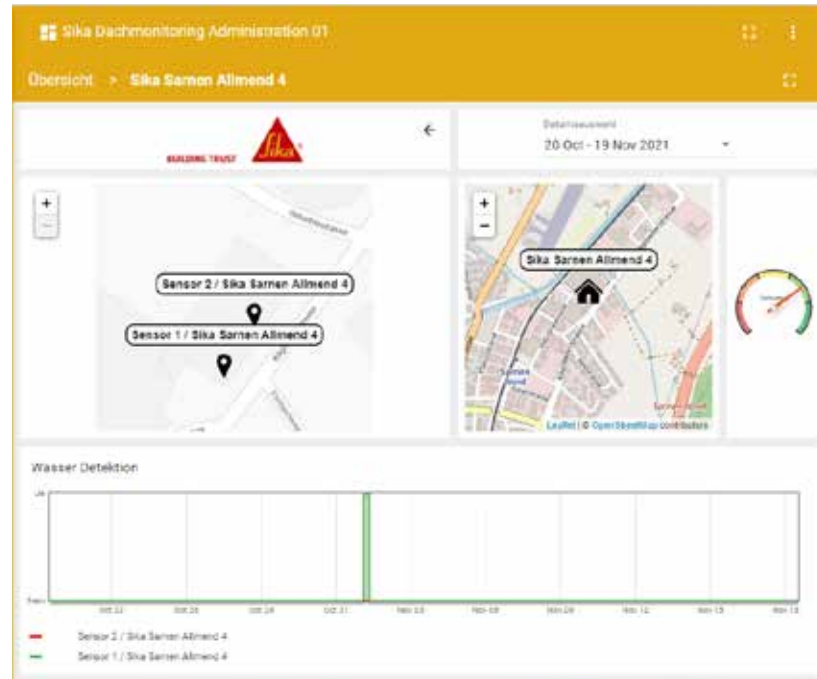

DESCRIPTION

Transmission from SikaRoof® Sensor monitored data to the Sika platform.

USES

In combination with SikaRoof® Sensor Active R / T.

STANDARD CONTROL / MONITORING SYSTEM



TERRACE CONTROL / MONITORING SYSTEM



TECHNOLOGY OVERVIEW THERMAL INSULATIONS

INTRODUCTION

Thermal insulation is one of the key construction elements, creating comfortable environment inside the building by protecting it from the heat and the cold.

The importance of thermal insulation has increased recently a lot due to continuously changing insulation standards worldwide, which put higher and higher demands to thermal resistance of building structures to reduce energy losses for heating or cooling. The main coefficient used for evaluation of such thermal characteristics is U-Value, which represents the energy transmission (loss) per 1 m² K of the building structure.

Insulation types used in flat roofing systems should have not only high thermal characteristics but sufficient mechanical properties as well to be able to withstand loads, which occur in various roof systems (like snow loads, limited pedestrian traffic for maintenance reasons, ballast, moisture in inverted roof build up, etc.) and to match specific fire requirements.

This section presents most common insulation types for this application and their suitability to Sika flat roof waterproofing systems. Properties of specific insulation products on the market may vary from listed general characteristics.

Product portfolio of Sika incorporates some of these insulation product types. For specific product information please refer to respective product brochures and data sheets.



Brochure:

Thermal Insulation with Sikatherm PIR Boards



PRODUCT TECHNOLOGIE - MAIN TECHNOLOGIES

PIR / PUR



PIR / PUR is a rigid polyisocyanurate foam produced in a chemical process (exothermic chemical reaction) made by mixing MDI, polyols, blowing agents (usually pentan gas) and other additives. The products are known for one of the lowest thermal conductivities.

Majority of PIR / PUR boards for flat roofing applications have facers. It can be aluminium or glass tissue or paper. Facers prevent outgassing effect.

CHARACTERISTICS / ADVANTAGES

- Excellent thermal characteristics
- Low weight
- Ideal for adhered applications
- High compression strength

Mineralwool



Mineral (stone) wool is a traditional building insulant known for its incombustible properties.

The mineralwool products are generally produced out of basalt in a physical process - basalt is heated up to 1500°C till it gets into liquid state, then fibres are formatted with air pressure and organic binders are added to better hold these fibers together.

Mineralwool products for standard flat roofing applications are single or dual density rigid boards with mechanical and compression strength properties sufficient for intended application.

CHARACTERISTICS / ADVANTAGES

- Non combustible
- Excellent acoustical properties
- Dimensionally stable

EPS



EPS (Expanded Polystyrene) is a plastic styrol foam made in physical process when polystyrene granules are expanded with vapour and then pressed together at high temperature to form blocks.

This is one of the most cost efficient insulations, which gained through that popularity on various local markets. In some countries it has a limited use on exposed roofs due to fire regulations, but majority of standard ballasted applications are done with this insulation.

CHARACTERISTICS / ADVANTAGES

- Cost efficient
- Low weight
- Ideal for gravel ballasted applications
- High compression strength

XPS



XPS (Extruded Polystyrene) is a plastic styrol foam produced with extrusion process. The polystyrene granules are mixed with the blowing agent (CO₂ or Freon) and then extruded. XPS has very high compression strength and very low water absorption and these unique advantages determine its most common applications - utility decks with high loads and inverted roofs (when thermal insulation is placed above waterproofing layer).

CHARACTERISTICS / ADVANTAGES

- Very high compression strength
- No or very low water absorption
- Low weight
- Ideal for inverted applications and utility decks with high loads (car traffic)

TECHNOLOGY OVERVIEW THERMAL INSULATIONS

PRODUCT TECHNOLOGIE – SPECIALITIES

Coverboard



Coverboards for roofing applications are usually non-structural, glass-mat faced, moisture-resistant, treated gypsum or cementitious core panels. This treated gypsum or cementitious core is an integral part of the inorganic glass mat surfacing on both sides. Such boards are installed to create rigid roofing surface and to bring additional thermal resistance to the roofing structure as well.

CHARACTERISTICS / ADVANTAGES

- Very high compression strength
- Excellent fire ratings

Cellular Glass



Cellular glass is manufactured primarily from sand, limestone, and soda ash. (recycled glass could also be used). These ingredients are melted into molten glass, which is cooled and crushed into a fine powder. The powdered glass is poured into molds and heated that causes the particles to adhere to one another. Next, a small amount of finely ground carbon-black is added, and the material is heated in a “cellulation” process. Here, the carbon reacts with oxygen, creating carbon dioxide, which forms the insulating bubbles in the foamglas.

CHARACTERISTICS / ADVANTAGES

- No water absorption
- High resistance to fire, non combustible
- High compression strength

High Density Board



The high density board is a flat roof overlay board for use in combination with PIR / PUR boards. It provides added protection to the insulation below in areas of excessive traffic and high loadings.

In addition to its compressive performance, high density board exhibits excellent dimensional stability, ideal in flat roofs which experience intense thermal cycling between cold winter temperatures and extremely hot summers.

CHARACTERISTICS / ADVANTAGES

- High compressive strength
- Excellent dimensional stability

PRODUCT TECHNOLOGIE – COMBINATIONS

EPS combined with Mineralwool



As an example EPS can be combined with Mineralwool, which can on one hand improve fire characteristics (compared to pure EPS build-up), provide higher compression strength and one other hand bring some additional cost efficiency.

Numerous combinations of several insulation types can be installed together in a single roof build-up to reach:

- Desired thermal values
- Higher compression strengths
- Extended fire characteristics
- Economical properties, etc.

CHARACTERISTICS / ADVANTAGES

- Combining strengths of various insulation types
- Improving acoustics
- Customized thermal insulation build up to special customer needs in case desired technical values or cost efficiency can not be reached with one product group

U-VALUES FOR ROOF BUILD-UP ON STEEL DECK (W/m²·K)



- Sarnafil® TS 77 roof waterproofing membrane
- Thermal insulation
- Vapour- control layer / barrier
- Steel deck 1.00 mm

	80 mm	100 mm	120 mm	140 mm	160 mm	180 mm	200 mm	220 mm	240 mm	260 mm
PIR / PUR Aluminium 0.023 W/(m·K)	0.28	0.22	0.19	0.16	0.14	0.13	0.11	0.10	0.09	0.09
PIR / PUR Glass Tissue 0.028 W/(m·K)	0.33	0.27	0.23	0.19	0.17	0.15	0.14	0.12	0.11	0.11
EPS Graphite 0.029 W/(m·K)	0.34	0.28	0.23	0.20	0.18	0.16	0.14	0.13	0.12	0.11
EPS Standard 0.037 W/(m·K)	0.43	0.35	0.29	0.25	0.22	0.20	0.18	0.16	0.15	0.14
XPS HCFC Blown 0.029 W/(m·K)	0.34	0.28	0.23	0.20	0.18	0.16	0.14	0.13	0.12	0.11
XPS CO₂ Blown 0.037 W/(m·K)	0.43	0.35	0.29	0.25	0.22	0.20	0.18	0.16	0.15	0.14
Mineral Wool 0.040 W/(m·K)	0.47	0.38	0.32	0.27	0.24	0.22	0.19	0.18	0.16	0.15

TECHNOLOGY OVERVIEW

THERMAL INSULATIONS

COMPATIBILITY OF MAIN THERMAL INSULATION TYPES TO SIKA ROOFING SYSTEMS

Material types	Mechanically fastened	Adhered	Gravel ballasted	Green and Utility	Inverted	Metal roof refurbishment
PIR / PUR	Compatible	Compatible	Compatible	Limited compatibility	Not compatible	Compatible
		Glass tissue, paper or aluminium faced boards shall be used.		Due to higher compression loads affecting thermal insulation.		Additional flute filler may be required depending on the metal profile.
Mineralwool	Compatible	Compatible	Limited compatibility	Very limited compatibility	Not compatible	Compatible
		Only special mineralwool boards with facings shall be used in order to provide good bond without extreme adhesive consumption.	Due to higher compression loads on thermal insulation. Every project needs an evaluation.	Due to higher compression loads on thermal insulation. Every project needs an evaluation.		Additional flute filler may be required depending on the metal profile.
EPS	Compatible	Compatible	Compatible	Limited compatibility	Not compatible	Compatible
	A separation layer shall be applied in case of special fire requirements.	Adhesive type shall be observed. Felt-back membranes can be adhered to EPS with Sarnacol®-2142 or Sarnafil® TG 76 FSA.		Due to higher compression loads affecting thermal insulation. Every project needs an evaluation.		Additional flute filler may be required depending on the metal profile. A separation layer shall be applied in case of special fire requirements.
XPS	Compatible	Compatible	Compatible	Compatible	Compatible	Compatible
	A separation layer shall be applied in case of special fire requirements.	Adhesive type shall be observed. Felt-back membranes can be adhered to XPS with Sarnacol®-2142 or Sarnafil® TG 76 FSA.				Additional flute filler may be required depending on the metal profile. A separation layer shall be applied in case of special fire requirements.
Coverboard	Compatible	Compatible	Compatible	Compatible	Compatible	Compatible

Note: Every project needs an evaluation.

MAIN VALUES THERMAL INSULATION

	PIR / PUR	Mineralwool	EPS	XPS
Thermal conductivity	Aluminium faced boards λ_e 0.022 – 0.025 W/(m·K)	λ_e 0.038 – 0.040 W/(m·K)	EPS with graphite λ_e 0.029 – 0.031 W/(m·K)	Standard boards, HCFC blown λ_e 0.029 – 0.034 W/(m·K)
	Glass tissue faced boards λ_e 0.024 – 0.030 W/(m·K)		Standard EPS λ_e 0.034 – 0.038 W/(m·K)	CO ₂ blown XPS boards λ_e 0.035 – 0.037 W/(m·K)
Compression strength	100 – 150 kPa	40 – 60 kPa	100 – 250 kPa	200 – 700 kPa
	It is sufficient for flat exposed applications and ballasted applications without heavy loads.	It is sufficient for flat exposed applications without heavy pedestrian load.	It is sufficient for flat exposed applications and most of ballasted applications.	It is sufficient for utility decks with car traffic.
Resistance to water absorption	Boards have high resistance to moisture absorption, but they still can not be used in inverted roofs.	Boards have limited resistance to moisture absorption.	Boards have high resistance to moisture absorption, but they still can not be used in inverted roofs.	Zero water absorption, can be used in inverted roofing applications.
Weight	30 to 40 kg/m ³	110 to 200 kg/m ³	20 to 30 kg/m ³	25 to 40 kg/m ³
		Most common density of the boards for flat roofing applications is around 150 kg/m ³ .		
Dimensional stability / average shrinking rates	Up to 1% in average	0%	up to 2% in average	up to 2% in average
Availability of tapered Insulation	Available	Available	Available	Available
	Can be either cut out of the block in production or can also be produced as a ready board with a pitch.	Can be either cut on site or in production process. Cutting mineral wool on site releases fibers which may irritate.	Is usually cut out of insulation block by heated wire in production or on the site.	Harder to cut than expanded polystyrene boards. Usually prefabricated in production.

TECHNOLOGY OVERVIEW

THERMAL INSULATIONS

BEHAVIOUR IN FIRE

EUROPEAN FIRE CLASSIFICATION		
Product Classification	System Classification	
Reaction to Fire according to EN 13501-1 Single product is tested to its behaviour in fire, smoke production, heat emissions, etc.	External Fire Exposure according to EN 13501-5 External fire exposure tests behaviour of roofing system with various slopes and various wind speeds to external fire influence (fire in on top of the roofing surface).	Fire Resistance of Structures according to EN 13501-2 Fire Resistance test represents how long the structure can resist fire without losing its structural abilities, integrity and insulation characteristics. Fire is applied from underneath the roofing structure.

PRODUCT CLASSIFICATION - REACTION TO FIRE ACCORDING TO EN 13501-1

Class	Description	Main characteristics	Related testing procedures
A1	Non combustible, Do not contribute to fire growth in any phase of fire including fully developed fire.	Increase of temperature $\leq 30^{\circ}\text{C}$, and weight loss $\leq 50\%$, and no sustained flaming	EN ISO 1182 and
		Combustion heat $\leq 2.0 \text{ MJ/kg}$	EN ISO 1716
A2	Gives no significant contribution to fire growth and fire load in a fully developed fire.	Increase of temperature $\leq 50^{\circ}\text{C}$, and Weight Loss $\leq 50\%$, and Sustained flaming $\leq 20 \text{ s}$	EN ISO 1182 or
		Combustion Heat $\leq 3.0 \text{ MJ/kg}$	EN ISO 1716 and
		Heat release rate $\leq 120 \text{ W/s}$, lateral flame spread $<$ specimen edges Total heat release within 600 s $\leq 7.5 \text{ MJ}$	EN 13823
B	Do not lead to flashover situation, however they will contribute to a fully developed fire.	Heat release rate $\leq 120 \text{ W/s}$, lateral flame spread $<$ specimen edges Total heat release within 600 s $\leq 7.5 \text{ MJ}$	EN 13823 and
		Spread of flame $\leq 150 \text{ mm}$ within 60 sec	EN ISO 11925-2 Exposure to fire 30 s
C	Shows limited fire spread during exposure to fire of single burning item, may lead to flashover situation, but only in the second part of the reference test, i.e. after more than 10 minutes.	Heat release rate $\leq 250 \text{ W/s}$, lateral flame spread $<$ specimen edges Total heat release within 600 s $\leq 15 \text{ MJ}$	EN 13823 and
		Spread of flame $\leq 150 \text{ mm}$ within 60 sec	EN ISO 11925-2 Exposure to fire 30 s
D	Can withstand small flame for certain time without significant fire spread, may lead to flashover situation in the first part of the reference test, i.e. within 10 minutes, but not before 2 minutes.	Heat release rate $\leq 750 \text{ W/s}$	EN 13823 and
		Spread of flame $\leq 150 \text{ mm}$ within 60 sec	EN ISO 11925-2 Exposure to fire 30 s
E	Are able to withstand small fire for a short time without significant spread of flame, may lead to flashover within 2 minutes.	Spread of flame $\leq 150 \text{ mm}$ within 20 sec	EN ISO 11925-2 Exposure to fire 15 s
F	Products which can not be classified under A-E classes.	No performance determined	

MATERIALS OF CLASSES A2 TO D ARE TESTED FOR SMOKE EMISSIONS

s1	s2	s3
Smoke development rate $\leq 30 \text{ m}^2/\text{s}^2$ Total smoke propagation in 600s $\leq 50 \text{ m}^2$	Smoke development rate $\leq 180 \text{ m}^2/\text{s}^2$ Total smoke propagation in 600s $\leq 200 \text{ m}^2$	Products which does not fulfil s1 and s2

MATERIALS OF CLASSES A2 TO D ARE ALSO TESTED FOR BURNING DROPLETS

d0	d1	d2
No droplets within 600 secs	Droplets burn for less than 10 secs within 600 secs	Products which does not fulfil d0 and d1

PIR / PUR	Mineralwool	EPS	XPS
Class E according to EN 13501-1	Class A1 according to EN 13501-1	Class E according to EN 13501-1	Class E according to EN 13501-1
The boards are classified as combustible, but they do not spread the flame, do not melt in fire and are self-extinguishing. The short temperature resistance is 250°C and long temperature resistance 90°C .	The boards are classified as incombustible.	The boards are classified as combustible, they melt during fire, but products are self-extinguishing. The short temperature resistance is $80 - 90^{\circ}\text{C}$.	The boards are classified as combustible, they melt during fire, but products are self-extinguishing. The short temperature resistance is $70 - 90^{\circ}\text{C}$.

SYSTEM CLASSIFICATION - EXTERNAL FIRE EXPOSURE EN 13501-5

Four basic tests can be done to evaluate external fire behaviour of the roof

	Test 1	Test 2	Test 3	Test 4
Testing pitch	$15^{\circ} / 45^{\circ}$	30°	$5^{\circ} / 30^{\circ}$	$0^{\circ} / 45^{\circ}$
Apply to following roof pitches	$< 20^{\circ} / \geq 20^{\circ}$	All pitches	$< 10^{\circ} / \geq 10^{\circ}$ and $< 70^{\circ}$	$< 10^{\circ} / \geq 10^{\circ}$
Fire	●	●	●	●
Wind		●	●	●
Radiant heat			●	●
2 stage test				●

THERMAL INSULATION PRODUCTS

Sikatherm® PIR GT



DESCRIPTION

Sikatherm® PIR GT is an insulation board for flat Roofing. It is faced on both sides with a coated glass tissue bonded to the insulation core and produces a tough, durable, light weight insulation board.

USES

Thermal insulation underneath Sarnafil® T roof waterproofing membranes.

CHARACTERISTICS / ADVANTAGES

- Produced with a blowing agent with zero Ozone Depletion Potential (ODP)
- Low thermal conductivity
- Ideal for new construction and refurbishment
- High compressive strength
- Light weight and low load on the roofing structure

Sikatherm® PIR AL



DESCRIPTION

Sikatherm® PIR AL is an insulation board for flat Roofing. It is faced on both sides with an aluminium composite foil bonded to the insulation core and produces a tough, durable, light weight insulation board.

USES

Thermal insulation underneath Sarnafil® T roof waterproofing membranes.

CHARACTERISTICS / ADVANTAGES

- Produced with a blowing agent with zero Ozone Depletion Potential (ODP)
- Ideal for new construction and refurbishment
- High compressive strength
- Light weight and low load on the roofing structure

Sikatherm® EPS



DESCRIPTION

Sikatherm® EPS are boards of expanded polystyrene with high thermal insulating properties, which remain unaffected in time.

USES

Thermal insulation underneath Sarnafil® T roof waterproofing membranes.

CHARACTERISTICS / ADVANTAGES

- Homogeneity of the physical and mechanical characteristics of the product and therefore isotropical behaviour
- Stability against tension, distortion, break, degradation and ageing.
- Ideal for new constructions and refurbishment projects
- Lightweight, applying thus low load on the roofing structure
- 100% recyclable

Sikatherm® XPS



DESCRIPTION

Sikatherm® XPS is a rigid extruded polystyrene insulation board with self-extinguishing properties that can be used as part of SikaRoof® waterproofing systems.

USES

Thermal insulation underneath and above Sarnafil® T roof waterproofing membranes.

CHARACTERISTICS / ADVANTAGES

- Very low thermal conductivity
- Ideal for new constructions and refurbishment projects
- High compression strength
- Lightweight and low load on the roofing structure
- Withstands freeze / thaw cycles
- Closed cell structure, which minimizes water absorption



PRODUCT OVERVIEW VAPOUR-CONTROL LAYERS / BARRIERS

BASICS

Moisture in today's buildings can be a source of continuous problems if not tackled professionally. This applies equally, to both new and existing buildings, particularly those that house high-tech- electronics, machinery and computer equipment, or which have moisture sensitive finishes or contents that need to be protected against condensation and its consequences.

The function of a vapour- control layer / barrier is firstly to avoid moisture build up in the fabric or structure of a building, where it could find its way into the insulation and reduce its thermal efficiency, or cause damage to other building elements. In addition to this, the vapour- control layer / barrier also serves to help secure the air tightness of the building.

	Sarnavap® -1000 E	Sarnavap® -2000 E	Sarnavap® -5000 E SA FR	Sarnavap® -5000 E SA	Sikavap -5000 E SK AL	SikaShield® VB E71 PE SA 3 kg/m²	SikaShield® VB P21 T 3 mm*
FM	●	●	●				
Properties							
Base material	Polyethylene (PE-LD)	Polyethylene (PE-LD / HD)	Aluminium / Polymer Bitumen	Aluminium / Polymer Bitumen	Aluminium / Hot Melt	SBS Modified Bitumen	APP Modified Bitumen
Color	Light blue	Green	Aluminium / PET film	Aluminium / PET film	Aluminium / PET film	Black	Black
Roll size (m)	5 x 25	4 x 25	1.08 / 1.38 x 40	1.08 x 30	1.50 x 50	1 x 10	1 x 10
Weight (g/m²)	195	230	400	650	135	3000	
Reaction to fire	Class E	Class E	Class E	Class E	Class E	Class E	Class E
Diffusion resistance factor μ	> 9'000'000	> 1'300'000	> 3'000'000	> 3'000'000	> 2'500'000	> 2'500'000	> 2'500'000
Diffusion equivalent air layer Sd (m)	≥ 200	≥ 300	≥ 1'800	≥ 1'800	≥ 1500	≥ 1500	≥ 1500
Moisture vapour transmission (g/m²/24 h)	< 0.8	< 0.3	< 0.04	< 0.04	< 0.06	< 0.06	< 0.06
Vapour resistance (M Ns/g)	> 900	> 1'450	> 9'000	> 9'000	> 7'500	> 7'500	> 7'500
Application							
High humidity		●	●	●	●	●	●
Moderate humidity	●	●	●	●	●	●	●
Low humidity	●	●	●	●	●	●	●
Vapour control layer	●	●	●	●	●	●	●
Vapour barrier			●	●	●	●	●
Accessories							
Sarnavap® Tape F	● Primer-130	● Primer-130					
Sarnatape® 20	● Primer-130	● Primer-130					
Primer-600				●		●	
Sika® Igoflex® P-01							●
Sika® Igoflex® P-10							●

● Achieved / Used with
* Product representing SikaShield® bituminous vapour barrier range

products according to CE Marking EN 13984
Sarnavap®-5000 E according to EN 13970

TYPE OF APPLICATION VAPOUR-CONTROL LAYERS / BARRIERS

Roof System / Substrate	Type of Application Vapour- Control Layers / Barriers		
	Loose laid	Self adhered	Torch applied
Mechanically fastened on steel or wood deck	Sarnavap®-1000 E* Sarnavap®-2000 E	Sarnavap®-5000 E SA Sarnavap®-5000 E SA FR Sikavap-5000 E SK AL SikaShield® VB E71 PE SA 3 kg/m²	○
Mechanically fastened, adhered or ballasted on concrete deck	○	SikaShield® VB E71 PE SA 3 kg/m²	SikaShield® VB P41 S 3 mm* SikaShield® VB P21 T 3 mm SikaShield® VB P42 S 3 mm
Adhered on steel or wood deck	○	Sarnavap®-5000 E SA	○

○ Not recommended
* Product to be indicated as possible option within the chapter STANDARD DETAILS in this Roofing Handbook

Positioning and type of vapour- control layer / barrier in accordance with local climate conditions, type of building and regulations and must be confirmed by an external building physicist. All build-ups need to be wind uplift tested in accordance to the local regulations.



Application Manual:
Vapour- Control Layers / Barriers



VAPOUR CONTROL LAYERS

Sarnavap®-1000 E



DESCRIPTION

Sarnavap®-1000 E is an unsupported vapour control layer based on Polyethylene (PE).

USES

- Vapour control layer is applied over most common substrates. Substrates should be smooth, dry and strong enough to support foot traffic
- Sarnavap®-1000 E vapour control layer is used for flat roofs

CHARACTERISTICS / ADVANTAGES

- Ease and speed of installation
- Stays flexible at low temperatures
- Non-decaying
- Constant vapour diffusion resistance
- Recyclable

APPEARANCE / COLOR

Surface:

- Smooth, PE-LD foil

Color:

- Light blue

Sarnavap®-2000 E



DESCRIPTION

Sarnavap®-2000 E is an unsupported vapour control layer based on Polyethylene (PE).

USES

- Vapour control layer is applied over most common substrates. Substrates should be smooth, dry and strong enough to support foot traffic
- Sarnavap®-2000 E vapour control layer is used for flat roofs

CHARACTERISTICS / ADVANTAGES

- Ease and speed of installation
- Stays flexible at low temperatures
- Constant vapour diffusion resistance

APPEARANCE / COLOR

Surface:

- Smooth, PE-LD / HD foil

Color:

- Green

VAPOUR BARRIERS

Sarnavap®-5000 E SA FR



DESCRIPTION

Sarnavap®-5000 E SA FR is a self-adhesive, multilayered, fire reduced, vapour barrier manufactured from polymer modified bitumen with a glass-fibre matt reinforcement and an aluminium foil top layer.

USES

Sarnavap®-5000 E SA FR may only be used by experienced professionals:

- As a vapour barrier over metal decks in combination with mechanically fastened roof assembly.
- Temporary waterproofing layer for up to 4 weeks
- Not approved for fully adhered roof systems

CHARACTERISTICS / ADVANTAGES

- Ease and speed of installation from self-adhesive properties
- Temporary waterproof top layer for up to 4 weeks, without the requirement for additional weight / ballast and / or mechanical fastenings
- Good adhesion / bonding strength leading to an air tight roof construction
- Good tear resistance to foot traffic during roof build up activities
- High water vapour resistance makes it suitable in
- combination with all types of membranes
- Can be bonded onto inclined or vertical surfaces
- Complies with the requirements of DIN 18234

APPEARANCE / COLOR

Surface:

- Aluminium foil with PET film

Sarnavap®-5000 E SA



DESCRIPTION

Sarnavap®-5000 E SA is a multi-layered, self-adhesive vapour barrier manufactured from polymer modified bitumen with a glass-fibre matt reinforcement and an aluminium foil top layer.

USES

Sarnavap®-5000 E SA may only be used by experienced professionals:

- As a vapour barrier over most common roof deck types:
 - Metal
 - Plywood panels, timber boards, oriented strand board (OSB)
- Temporary waterproofing layer for up to 4 weeks

CHARACTERISTICS / ADVANTAGES

- Ease and speed of installation from self-adhesive properties
- Can be used in a fully adhered roof build-up. No additional fasteners required for securing the thermal insulation boards to the structural deck
- Temporary waterproof top layer for up to 4 weeks, without the requirement for additional weight / ballast and / or mechanical fastenings
- High self adhesion strength allows high wind design loads from 2,4 kN/m² to 2,8 kN/m²
- Provides an air tight layer
- High tear resistance to foot traffic during roof build up activities
- High water vapour resistance makes it suitable in combination with all types of membranes
- Accommodates a wide range of roof system, deck types and substrate combinations
- Can be bonded onto flashings, inclined or vertical surfaces

APPEARANCE / COLOR

Surface:

- Aluminium foil with PET film

VAPOUR BARRIERS

Sikavap-5000 E SK AL



DESCRIPTION

Sikavap-5000 E SK AL is a self-adhesive, multi-layered, vapour barrier manufactured with a glass-fibre mat reinforcement and an aluminium foil top layer. The bottom layer consists of a hot melt adhesive with a release liner.

USES

The Product is used as a:

- Vapour barrier over metal and wooden decks in combination with mechanically fastened roof construction
- Temporary waterproofing layer for up to 4 weeks.

Please note:

- The Product may only be used by experienced professionals
- The Product may only be used in combination with a mechanically fastened roof assembly
- Do not use as a permanent waterproof layer
- Not approved for fully adhered roof systems

CHARACTERISTICS / ADVANTAGES

- High water vapour resistance makes it suitable in combination with all types of membranes
- Temporary waterproofing layer without the need for additional weight, ballast or mechanical fastenings
- Good adhesion strength leading to an air tight roof construction
- Fast and easy installation using self-adhesive properties
- Good tear resistance to foot traffic during roof build-up activities
- Can be bonded onto different types of substrates

APPEARANCE / COLOR

Surface:

- Aluminum foil with PET film

SikaShield® VB E71 PE SA 3 kg/m²

DESCRIPTION

SikaShield® VB E71 PE SA 3 kg/m² is an SBS modified bituminous self-adhesive vapour barrier with a weight of 3 kg/m² and flexible at -25°C. It is reinforced with aluminium foil and a dimensionally stable non-woven polyester inlay to provide an excellent barrier to the passage of the vapour. The top surface is covered with a polyethylene foil to bond the insulation panels with molten bitumen or by mechanical fixation. The underside has a removable liner over the adhesive compound for easy application.

USES

- The Product is used as a waterproofing membrane for:
- Flat and sloped roofs
- High humidity roof spaces (+20°C ≤ 80% RH)

CHARACTERISTICS / ADVANTAGES

- Flame-free application
- Highly flexible in cold temperatures
- Good adhesion in cold temperatures
- High durability
- Fast and easy installation

APPEARANCE / COLOR

Surface:

- Polyethylene foil

SikaShield® VB P21 T 3 mm



DESCRIPTION

SikaShield® VB P21 T 3 mm is an APP modified bituminous roofing vapour barrier with a thickness of 3 mm and flexible at -0°C. It is reinforced with aluminium foil and a dimensionally stable non-woven polyester inlay to provide an excellent barrier to the passage of the vapour. The top surface is covered with talc to bond the insulation panels with molten bitumen or by mechanical fixation. The underside of the product has a burn-off film for easy torch-application.

USES

The Product is used as a waterproofing membrane for:

- Flat and sloping roofs
- High humidity roof spaces (+20°C ≤ 80% RH)

CHARACTERISTICS / ADVANTAGES

- Easy to install by torching method
- Good durability
- High resistance to water vapour movement

APPEARANCE / COLOR

Surface:

- Talc

Bottom surface:

- Polyethylene foil

VAPOUR- CONTROL LAYERS / BARRIERS ACCESSORIES

Sarnavap® Tape F



DESCRIPTION

Sarnavap® Tape F is a butyl rubber, double-sided adhesive sealing tape with a controlled stretch range.

USES

This product may only be used by experienced professionals:

- Taping lap splices in Sarnavap® vapour control layers (polyethylene) based material and for attaching Sarnavap® vapour control layers to smooth surfaces.

CHARACTERISTICS / ADVANTAGES

- Finger-lift release liner
- Controlled adhesive stretch range
- High durability
- Used only at airtight level

APPEARANCE / COLOR

Appearance:

- Smooth flat profile
- Color:
- Black

TECHNICAL INFORMATION

Length: 40.00 m
Width: 15 mm
Thickness: 1.00 mm

Sarnatape®-20



DESCRIPTION

Sarnatape®-20 is a butyl rubber, double-sided adhesive sealing tape with a controlled stretch range.

USES

Sarnatape®-20 may only be used by experienced professionals:

- Applied at airtight level for taping of seams, connections, terminations and detailing Sarnavap® vapour control layers (polyethylene).

CHARACTERISTICS / ADVANTAGES

- Finger-lift release liner
- Controlled adhesive stretch range
- High durability
- Good adhesion

APPEARANCE / COLOR

Appearance:

- Smooth flat profile
- Adhesive:
- Anthracite

TECHNICAL INFORMATION

Length: 20.00 m
Width: 20 mm
Thickness: 1.50 mm

Primer-130



DESCRIPTION

Primer-130 is a 1-part, ready to use, solvent-based primer for improving the adhesion properties of porous substrates before applying Sarnatape.

USES

Primer-130 may only be used by experienced professionals:

- Substrate primer for Sarnatape® butyl rubber adhesive tape.

CHARACTERISTICS / ADVANTAGES

- 1-part ready to use
- Easily applied by brush
- Good adhesion to different structural decks and substrates

Primer-600



DESCRIPTION

Primer-600 is a synthetic rubber and resin based 1- part ready to use primer for improving the adhesion properties of specific Sarnavap®-5000 E SA vapour barrier or Sarnafil® T roof waterproofing membranes.

USES

A primer for applying self-adhesive technologies onto various substrates:

- Sarnavap®-5000 E SA
- Sarnafil® T roof waterproofing membranes

CHARACTERISTICS / ADVANTAGES

- Proven performance over decades
- Easily applied
- Flame free application
- High adhesion to different structural deck types and substrates
- 1-part ready to use
- Increased adhesion for the specific membrane types
- Applied by brush or roller

Sika® Igoflex® P-01 / P-10



Sika® Igoflex® P-01

DESCRIPTION

Sika® Igoflex® P-01 is a 1-part, polymer modified, ready to use bitumen emulsion.

USES

Primer for bitumen thick coatings and bituminous sheet membranes to improve the adhesion and substrate consolidation of:

- Concrete
- Mortar
- Masonry

CHARACTERISTICS / ADVANTAGES

- Non-flammable
- Quick drying time
- Ready to use
- Good penetrating ability into porous substrates
- Applied by brush, roller or airless spray
- Can be applied on slightly damp surfaces

Sika® Igoflex® P-10

DESCRIPTION

Sika® Igoflex® P-10 is a 1-part solvent-based ready to use bituminous primer.

USES

Primer for bitumen thick coatings and bituminous sheet membranes to improve the adhesion and substrate consolidation of:

- Concrete
- Mortar
- Masonry
- Improves the adhesion to:
- Wood
- Metal

CHARACTERISTICS / ADVANTAGES

- Quick drying time
- Good adhesion
- Good penetrating ability into porous substrates
- Applied by brush, roller or airless spray
- Can be applied on slightly damp surfaces
- Ready to use

Sika SolaRoof® SYSTEM

The Sika SolaRoof® system is a lightweight, non-penetrating, integrated solar solution for thermoplastic roofs that outperforms conventional mounting systems. It combines the proven performance of a Sika roofing system with Sika® SolarMount-1 (SSM1) – an innovative, engineered solution for long-term securement of rooftop photovoltaic modules.

ROOFTOP PV – THE PERFECT USE OF EMPTY ROOF SPACE

Rooftop solar installations are becoming increasingly popular worldwide. An empty flat roof is a wasted space resource and most are not shaded. That's why more and more building owners are realizing the opportunity to make effective use of their roof space and to improve their environmental footprint through sustainable electricity production. Such installations are sound investments, designed to provide a return over the long-term. In addition, they reduce dependency on utility providers thanks to on-site power generation for in-house consumption.



The roofing system is a critical component of the installed PV plant. The correct roof build-up is key when it comes to durability. Sika has 50+ years of experience in the manufacture of single-ply membranes that not only meet the demands for performance and life expectancy as stand-alone waterproofing systems but also form an ideal substrate for the Sika® SolarMount-1 system.



Brochure:
Sika® SolarMount-1



Brochure:
Sika SolaRoof®



Brochure:
Sika SolaRoof®

ARCHITECTURAL AND STRUCTURAL REQUIREMENTS

Building height	<ul style="list-style-type: none"> Max. 20 meters. Higher roofs must be individually assessed
Roof slope	<ul style="list-style-type: none"> Up to 5° (1:12 or 8%) as standard Up to 10° with additional measures¹⁾
Roof loadbearing capacity	<ul style="list-style-type: none"> Sufficient for SSM1 loads. This can be determined by a structural engineer once the PV system has been planned
Sika roofing membrane	<ul style="list-style-type: none"> New membrane provides optimal roof warranty coverage. → The life expectancy of the Sika roof build-up and the PV system match perfectly Sarnafil® T roof waterproofing membrane, min. thickness 1.5 mm (2.0 mm for max. warranty coverage)
REQUIREMENTS FOR THE ROOF BUILD-UP ¹⁾	
Membrane fastening	<ul style="list-style-type: none"> Mechanically fastened¹⁾
Thermal insulation	<ul style="list-style-type: none"> PIR, EPS, XPS board (depending on local availability and temperature conditions) Mineral fiber board with compressive strength ≥ 70 kPa at 10% deformation (as per EN 826) Roof cover boards as an option for optimum load distribution
Vapor control layer	<ul style="list-style-type: none"> According to specific building physics requirements
Roof structure	<ul style="list-style-type: none"> Metal deck (trapezoidal), concrete, wood (PIR metal sandwich panels and standing seam metal roofs are not suitable for Sika SolaRoof®) The life expectancy of an existing roof structure with a new Sika build-up (reroofing) should be at least as long as that of the PV system

¹⁾Depends on local product range, standards and approvals

Please consult Sika or Centropal to assess whether your specific roof is suitable for installation of a Sika SolaRoof®.

Sika® SolarMount-1 is the aerodynamic mounting system for Sika SolaRoof®. It is used for the installation of rigid photovoltaic (PV) modules on flat or low-slope roofs. SSM1 can easily be installed on mechanically fastened or fully adhered Sika single-ply FPO and PVC membranes, depending on the local product range, standards and approvals.

SSM1 SYSTEM COMPONENTS

Sika® SolarClick



The Sika® SolarClick welding flange is injection molded from compounds compatible with the roofing membrane and is hot-air welded to the membrane to provide permanent and secure attachment. The flanges are mechanically fastened to the mount and transfer horizontal wind loads to the roof structure.

SSM1 mount



Injection-molded **SSM1 mount** (recycled PP) with an angle of inclination of 15° (angle is not adjustable). Fixed mounting rails hold the PV modules in place.

SSM1 mount with two Sika® SolarClick flanges

Accessories

Wind deflectors (for south orientation), module mounting rails, screws and clamps.

SSM1 KEY FEATURES

Module inclination angle	<ul style="list-style-type: none"> 15° to the roof plane
PV module orientation	<ul style="list-style-type: none"> PV modules on SSM1 mounts can be installed with either south or east-west orientation. The same components are used for both variants
PV module types	<ul style="list-style-type: none"> Framed crystalline PV panels with a width of up to 1058 mm
Average weight	<ul style="list-style-type: none"> Ca. 10 – 18 kg/m² (including PV modules, depending on south or east-west orientation) Green roof system < 40 kg/m² (including PV modules; vegetation mat saturated)
Load transfer	<ul style="list-style-type: none"> Slip sheets, separation layers, or friction enhancers are not required. Fixation of the SSM1 system requires no penetration of the roof build-up.

SSM1 ON LIGHTWEIGHT GREEN ROOFS

Sika® SolarMount-1 can also be used in combination with a lightweight green roof system. The advantages include low roof loads and lower maintenance than roofs with a "standard" green roof substrate. The system provides a water runoff coefficient of < 0.5 according to the Institute for Landscape Architecture, Leibnitz University Hannover, Germany.

Sika SolaRoof® SYSTEM

SOUTH ORIENTATION



EAST-WEST ORIENTATION



LIGHTWEIGHT GREEN ROOFS



SOUTH ORIENTATION

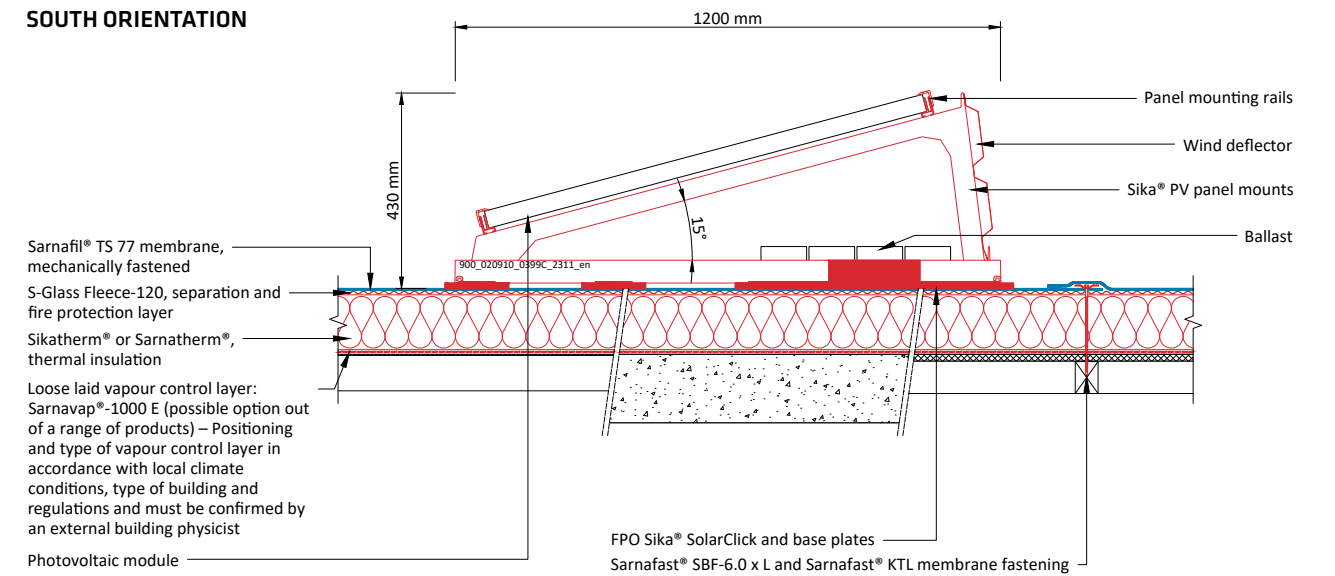

EAST-WEST ORIENTATION

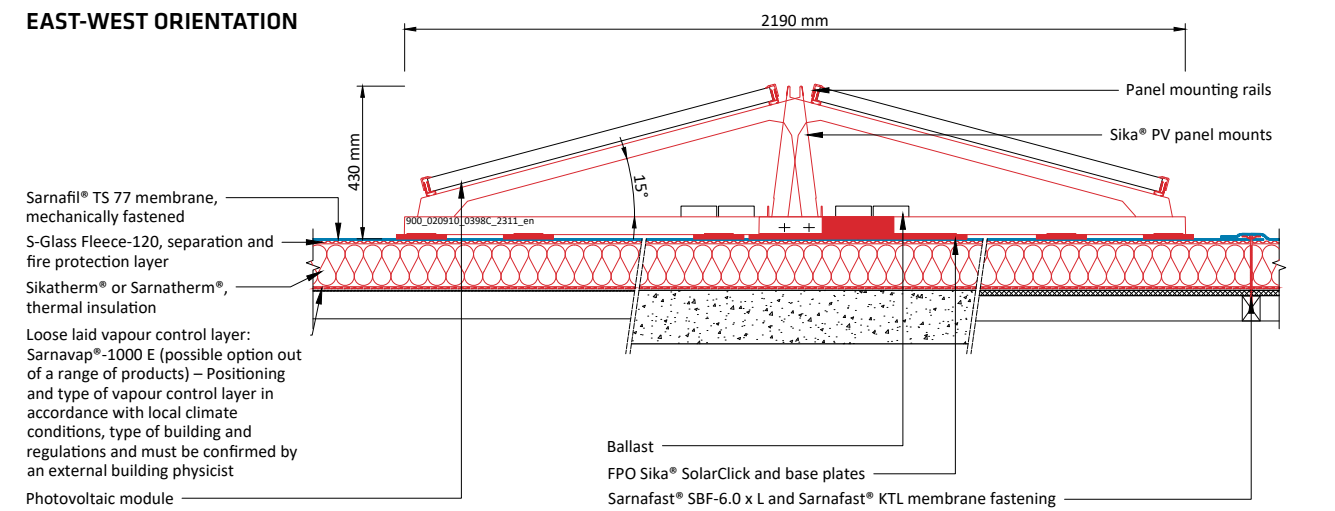

LIGHTWEIGHT GREEN ROOFS

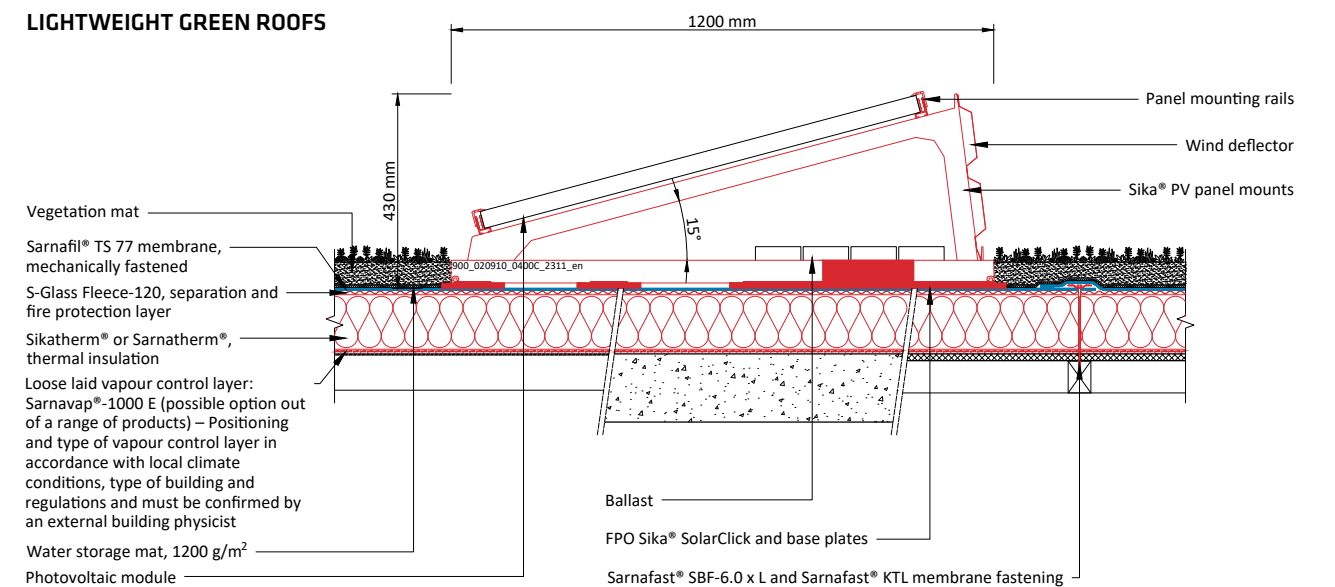

Lightweight green roof build-up*: The green roof build-up is installed between the PV module rows only. The roof surface beneath the PV modules remains uncovered in order to avoid uncontrolled plant growth and the associated high maintenance costs.
*Local regulations for green roofs and fire protection must be observed.

Sika SolaRoof® SYSTEM

Thorough full-system testing of SSM1 on single-ply membrane roofs has been conducted in several international labs since 2012. The results confirm superior performance in south and east-west configurations – even under extreme conditions. Certificates and approvals are available.

Mechanical testing of all components and connections on original Sika roof build-ups (roof structure, thermal insulation, membrane including fastening system) has been conducted at different temperatures in close coordination with various regulating bodies and construction institutes:

- Static testing
- Dynamic testing (load cycles at increasing load levels up to failure)
- Temperatures: -20°C, +23°C, +80°C
- Fire testing as per UL 2703, Section 15, Fire Performance

The following loading conditions were tested:

- Horizontal loading (parallel to the frame axis)
- Lateral loading (perpendicular to the frame axis)
- Load distribution tests of multiple SSM1 frames

All test series showed sufficient factors of safety for the SSM1 system as well as for the membrane and its fastening system performing under the following loading and conditions:

- Wind loads
- Seismic loads
- Low and high temperatures
- Material aging throughout the product service life
- Broad general environmental exposure

Stable positioning of SSM1 does not rely on friction between the membrane and the mounting structure. SSM1 will not shift its position on the roof due to changing material characteristics as a result of weathering and aging or due to material expansion and contraction.



Horizontal load testing of an SSM1 mount in a climate chamber

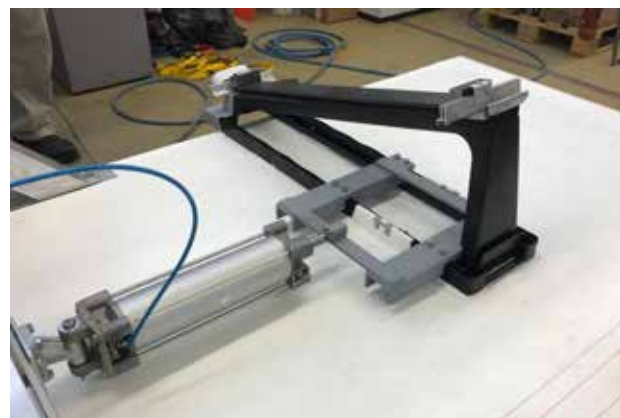

Lateral load testing of an SSM1 mount

The engineering phase is one of the most crucial steps of the project. Special focus is placed on site-specific conditions and influences such as wind and snow loads, roof build-up, solar exposure, objects above the roof (e.g. chimneys, trees), and energy yield. The engineered solution must take all these factors into account as well as meet the client's expectations regarding budget, return on investment, and intended on-site energy consumption or storage, etc.

The design and structural calculations for the SSM1 system are handled by the specialized PV solution provider Centroplan GmbH, a competence center for efficient and economical rooftop and solar solutions, with subsidiaries in the USA, China, and other countries. Their experienced engineers use custom software for SSM1 design.



The SSM1 design concept is as follows:

- Horizontal wind loads (parallel to the roof) are transferred via Sika® SolarClick fasteners to the membrane and the roof structure. No slip sheets or ballast is required.
- Vertical wind loads (uplift) are countered by the dead weight of the SSM1 elements and the PV modules. This makes the SSM1 system ideal for lightweight roofs. In rare cases of extreme uplift, ballast units can be placed in the recess of the mounts.

Boundary-layer wind-tunnel testing in specialized labs is conducted in order to determine the actual loads that the SSM1 installation will be exposed to. The custom software is used calculate the required number of SolarClick elements and the spacing of the mounts for each sub-array. The output includes a project-specific PV module layout, a ballast plan, and construction documents.

In south-oriented configurations, the typical row spacing is 1.5 to 2.5 m. The proposed aisle width for east-west installations is roughly 0.5 m in order to allow easy access for maintenance. Roof perimeter setback is typically 1.0 – 1.5 meters.

In any case, an SSM1 installation adds a moderate additional roof load of 10 – 18 kg/m² (incl. PV modules). The roof structure must be strong enough to carry this additional load.

Wind load calculations for the roof build-up are prepared by the local Sika company. Gravel ballasted membranes must be mechanically fastened as well as exposed roofs in order to resist horizontal wind loads.

Sika conducts a monitoring program for the most exposed SSM1 installations. Periodic examinations are conducted in order to check for material changes of components or other irregularities of membranes and fasteners.

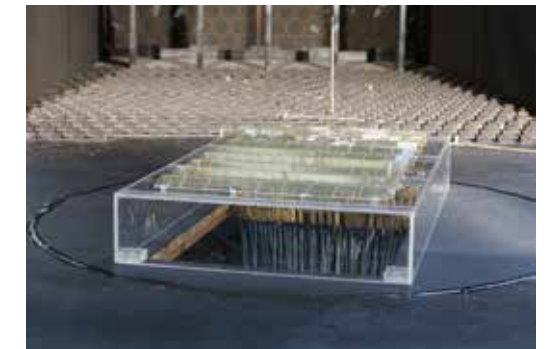

Building model with SSM1 system in wind tunnel

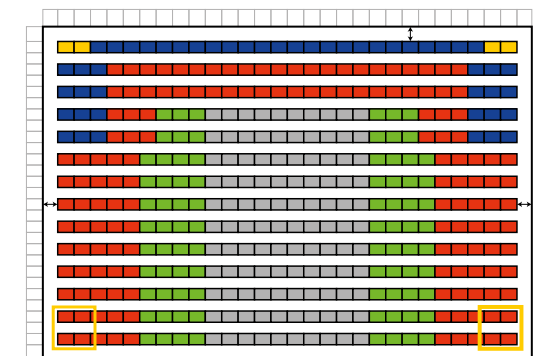

Various wind load zones of a general SSM1 installation

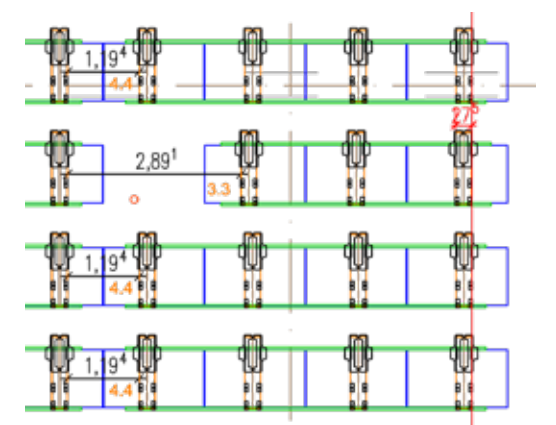

Roof specific PV module installation plan

Sika SolaRoof® SYSTEM

A unique feature of Sika® SolarMount-1 is that the installation cannot move on the roof surface over the long term. The Sika SolarClick fasteners are attached to the roofing membrane by hot-air welding and transfer the loads to the roof structure. Strong emphasis is placed on the training of contractors authorized to weld Sika roofing components.

SSM1 PV MODULE ORIENTATION AND VARIANTS

A big advantage of the Sika® SolarMount-1 system is the modular design, which makes it easy to accommodate specific conditions on the roof. SSM1 variants from 1 to 4 PV modules mounted on 2 to 7 mounts are so-called “standard” south-oriented configurations (e.g. Sika® SolarMount-1 3.4: 3 modules on 4 supports).

SSM1 COMPONENTS DELIVERY TO SITE

All Sika® SolarMount-1 components are delivered exclusively and directly to the job site from the Centroplan distribution center. They are packed on pallets and in box pallets for simplified logistics. These pallets are placed on the roof, which must be capable of carrying the concentrated loads.

SSM1 components may be delivered only to projects that have been calculated and designed by Centroplan and for which layout and ballast plans are available.

ROOF AND MATERIAL PREPARATION

It must be ensured that the roof surface is clean before the SSM1 system is installed.

For larger installations it is recommended to preassemble the SSM1 mounts on assembly tables. This speeds the installation and allows working at a more comfortable height.

SSM1 INSTALLATION

In order to achieve the greatest flexibility in installation, the roofing contractor that installed the roof build-up can also install the Sika® SolarMount-1 system, after having completed the corresponding training program.

Installation of the SSM1 system requires only a limited number of components to be assembled on site. This allows fast and easy setup of the PV plant. Installation manuals with step-by-step illustrations are provided by Sika.

Welding the Sika® SolarClick fasteners is the most demanding work step. The Sika registered or certified contractor that installed the roof system may also weld the Sika® SolarClick elements to the roof membrane. This allows the warranty to be provided by a single company, which is an additional benefit for the roof owner.

Sika® SolarClick fasteners are welded to the membrane with standard equipment and welding parameters, the same as for the respective Sika® roofing membrane. Welding can be done manually or with a semi-automatic welder. The installation of the Sika® SolarMount-1 system does not require any roof membrane penetrations or the use of slip sheets.



Preparation of system components on a workbench



Hot-air welding of a Sika® SolarClick flange



Installation in progress

The SSM1 installation track record is impressive: In international collaboration with the PV company Centroplan GmbH, over 1,000 Sika® SolarMount-1 plants have been installed over Sika roofing membranes since 2013.

SSM1 PLANTS HAVE BEEN INSTALLED ON 3 CONTINENTS:

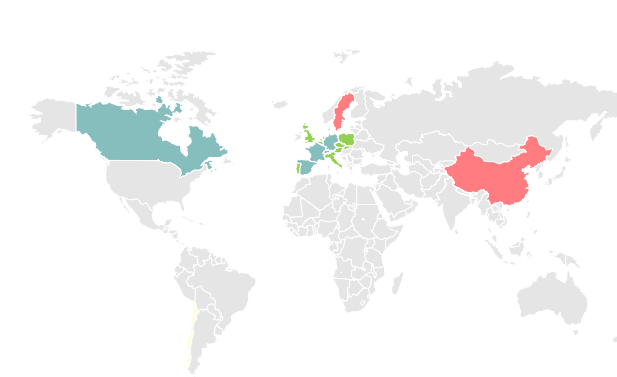

SIKA SSM1 DEMO INSTALLATIONS



Sika has installed some small SSM1 plants on its own buildings. Guided tours can be requested from the local sales teams.

EXAMPLES ILLUSTRATING THE VERSATILITY OF SSM1 IN TERMS OF MEMBRANES AND SUBSTRATES



Vilar do Paraíso, Portugal



Nauset, MA, USA



Montabaur, Germany



Dormagen, Germany

SikaRoof® ANCHOR SYSTEM

INTRODUCTION

The prefabricated roof connection point SikaRoof® Anchor 250 mm FPO is a universal connection point for fixing roof mounted products to exposed Sarnafil® T flat roof systems.



SikaRoof® Anchor 250 mm FPO



SikaRoof® Anchor Washer 140 mm



DESCRIPTION

SikaRoof® Anchor 250 mm FPO and SikaRoof® Anchor Washer 140 mm are a manufactured preformed accessory providing a secure watertight connection directly between the roof substructure / roof deck and waterproofing membrane.

USES

SikaRoof® Anchor 250 mm FPO and SikaRoof® Anchor Washer 140 mm may only be used by experienced professionals. Universal connection point for fixing roof mounted products to exposed Sarnafil® T roof waterproofing membranes.

CHARACTERISTICS / ADVANTAGES

- Provides a secure watertight anchor to the roof deck
- Resistant to UV radiation
- Heat weldable Adaptable for different substrates and mounting requirements
- Removes the wind load off the membrane and onto the structural deck

APPEARANCE / COLOR

Membrane:

- Beige
- Window grey (~RAL 7040)
- Traffic white (~RAL 9016)

Washer:

- Stainless steel



Brochure:
SikaRoof® Anchor System

TECHNICAL INFORMATION

SikaRoof® Anchor 250 mm FPO

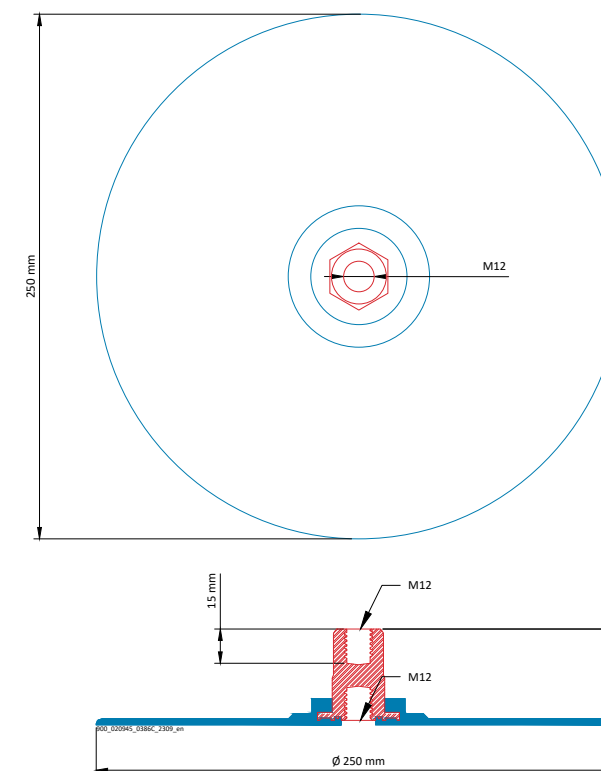

SikaRoof® Anchor Washer 140 mm

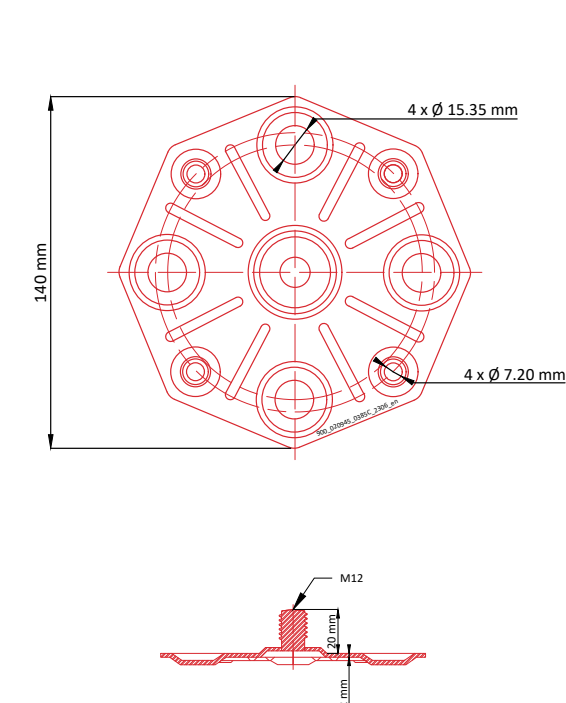

TYPICAL APPLICATION

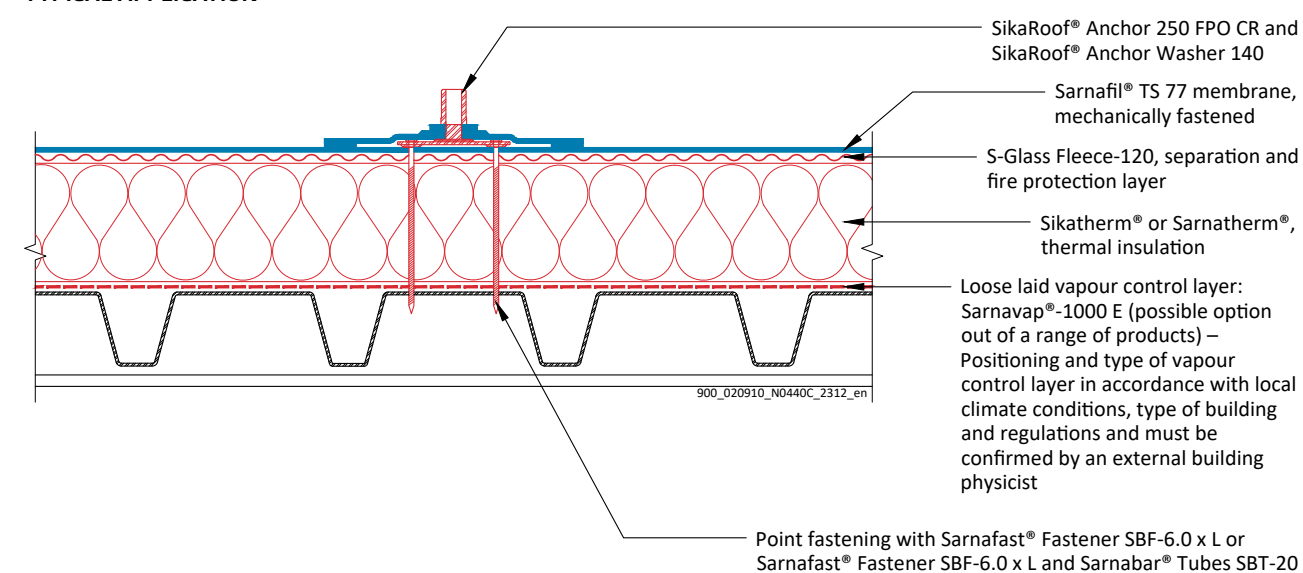

APPLICATION TOOLS

Varimat V2*



DESCRIPTION

With the innovative Varimat V2 welding machine, Sarnafil® T roof waterproofing membranes are welded quickly and economically. The automatic welder can be easily operated by one person thanks to the adjustable guide handle. The machine is also equipped with optimal ergonomics, easy handling and the “e-Drive” operating unit: The digital display not only shows the temperature control, but stores the welding parameters to ensure optimal welding seams, even after breaks or over days.

USES

Overlap welding of Sarnafil® T roof waterproofing membranes. Can also be used in areas close to edges and on uneven surfaces.

CHARACTERISTICS / ADVANTAGES

- Process reliability: Machine cuts out if undervoltage is too high
- Patented spherical roller compensates unevenness
- Guide bar for ergonomic handling
- Maintenance free blower means lower service costs
- User-friendly display with “e-Drive” (press and turn control) to recall preset and saved welding settings
- Constant drive with regulated electronics

Leister Triac AT / ST*



DESCRIPTION

Hand welding tool for welding membranes.

USES

For the hand welding of Sika Sarnafil® roof waterproofing in the overlapping of details and straight welds.

*Supplied by local Leister sales organization www.leister.com



SPARE PARTS FOR LEISTER HAND WELDING TOOL*

	Product	Uses
	Wide slot nozzle - 20 mm, 15° angled	Standard welding nozzle for details
	Wide slot nozzle - 20 mm, 60° angled - horizontal	Welding nozzle for difficult accessible detail parts
	Wide slot nozzle - 20 mm, 75° angled - vertical	Welding nozzle for difficult accessible detail parts
	Wide slot nozzle - 40 mm, 15° angled	Standard welding nozzle for straight welds
	Tubular nozzle - 5 mm diameter, 15° angled	Suitable for speed welding nozzle
	Speed welding nozzle - 8 mm diameter	For the installation of Sarnafil® T Welding Cord
	Pressure roller with ball bearings - 28 mm, PTFE	Pressure roller in the hot welding process
	Pressure roller with ball bearings - 28 mm, silicone	Pressure roller in the hot welding process
	Pressure roller with ball bearings - 6 mm (brass)	Pressure roller in the hot welding process
	Chamfer tool	Chamfering tool along transverse joints of hot welded membranes
	Chamfer tool sharpener	For the sharpening of chamfer tool

Sarnafil® Gas Heating Gun



DESCRIPTION

Device for heating Sika Sarnafil® roof waterproofing membranes when bonding connections at low outside temperatures.

OTHER INFORMATION

A commercially available gas cylinder is required on site.

Spray Application Gun

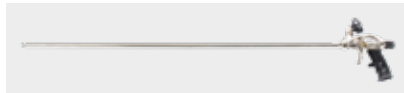

USES

Spray gun to be used for the application of SikaRoof® Board Adhesive, polyurethane 1- part, foam adhesive.

SYSTEM PRODUCT

SikaRoof® Board Adhesive

Fitting Tool for Sarnabar®



DESCRIPTION

Aluminum board with striking surface and tread area.

USES

This tool facilitates the installation of the Sarnabar® edge rail for throat fixation. Both hands remain free for drilling and screwing, as the edge rail is held with the foot by the mounting tool.

Sika Membrane slitter



DESCRIPTION

The Sika Membrane slitter is generally made of galvanized steel and aluminium.

USES

The Sika Membrane slitter is a tool to cut membrane strips on job site.

CHARACTERISTICS / ADVANTAGES

- Easy and safe to use
- Enables to cut membranes strips custom-fit on job site
- Enables to cut the strip to the desired width around the parapet perimeter
- Can even be used on already applied membranes without damage due to a special protector device
- Tool can be used in upright ergonomic position



SERVICE INFORMATION

PRODUCT INFORMATION

APPLICATION INSTRUCTIONS

STANDARD DETAILS

SUSTAINABLE SOLUTIONS



APPLICATION INSTRUCTIONS

BASICS	132
DETAILING WITH Sikalastic®-625 N	140
Sikalastic®-625 N PRODUCTS	143
FALL ARREST SYSTEM	146
MECHANICALLY FASTENED ROOF SYSTEM - SPOT FASTENING	148
MECHANICALLY FASTENED ROOF SYSTEM - INDUCTION WELDING	152
MECHANICALLY FASTENED ROOF SYSTEMS - GENERAL	156
GRAVEL BALLASTED ROOF SYSTEM	160
INVERTED ROOF SYSTEM	164
UTILITY ROOF SYSTEM	168
GREEN ROOF SYSTEM	172
ADHERED ROOF SYSTEM	176
ROOF REFURBISHMENT	181

BASICS

BASICS	The basis for the application of Sarnafil® T roof waterproofing membranes beside the Roof Handbook Sarnafil® T are the application manual for Sarnafil® TG / TS and the latest versions of product data sheets. In addition to that the product information, the standard details and the inputs regarding mechanically fastened, ballasted and adhered roof systems.
DELIVERY / PACKAGING / STORAGE	Sarnafil® T roof waterproofing membranes will be delivered in rolls – individually wrapped and palletized. Building site storage of membranes horizontally, on pallets and protected against humidity, dirt, dust and exposure.
MEMBRANE CUTTING	Cut Sarnafil® T roof waterproofing membrane with a scissor, knife or Sika® Membrane slitter. Please take also notice of the range of available strips in our delivery program.
SUBSTRUCTURE / FIRE PROTECTION	Depending on the roof system adjustment with the subconstruction need to take place. Your Sika roofing specialist can support you perfectly. Certain Sarnafil® T roof waterproofing systems are resistant and therefore approved against spreading of fire on roofs without protective or covering layers. Fire protection requirements of specific country need to be considered.
SUPPORT LAYER	A support layer need to be installed above trapezoidal metal deck constructions. This can either be thermal insulation with sufficient compression strength or plain metal sheet.
VAPOUR- CONTROL LAYER / BARRIER	The type of vapour- control layer / barrier to be chosen depends on the roof build-up and boundary conditions (indoor and outdoor clima). In case of not airtight sub – constructions (wood planking, trapezoidal metal sheets, prefabricated elements etc.), vapour- control layer / barrier need also take over the function of airtight layer.
THERMAL INSULATION LAYER	Depending on the roof system to be chosen, thermal insulation layer will be loosely laid, mechanically fastened or adhered. Guidelines of thermal insulation producer need to be followed. Thermal insulation plates applied in staggered bond pattern.
SEPARATION- / LEVELLING LAYER	If needed separation- / levelling layer installed based on the chosen roof build-up.
REFURBISHMENTS	Existing roof must be assessed carefully before a suitable refurbishment proposal can be prepared. Visual inspection of the buried roof layers should be made by opening the roof or taking core samples. The design should consider the following: <ul style="list-style-type: none"> ■ Condition of the roofing membrane and all flashing details ■ Building regulations ■ Whether the thermal insulation is dry ■ Whether the vapour control layer functions adequately ■ Whether the roof structure can support the design loads ■ Whether roof drainage is sufficient ■ Whether adjacent construction is sound or requires work <p>Sika Roofing guidelines and application instructions for new roofs also apply to refurbishment work. If only certain parts of the roof are to be refurbished, it is advisable to consider separating the new areas from the old areas by installing area dividers or waterstops. This will prevent any leaks in the old roof from affecting the performance of the new roof.</p>

GENERAL Sarnafil® T MEMBRANE WELDING

Sarnafil® T membranes will be homogenous joined by thermal welding process. Sarnafil® TG / TS membranes must be prepared for welding. During installation and in case of repair, different cleaning and seam preparation procedures may apply. Sarnafil® T membranes must be overlapped by 80 mm for the loose and adhered roof system whilst 120 mm for the mechanically fastened system. Regarding detailing we refer to application manual Sarnafil® TG / TS and the width range of prefabricated parts to be offered.

Welding tools

Only Sika recommended welding tools should be used. Sarnafil® T roof waterproofing membranes will be hot welded, either with hand welder or automatic welding machine.

Test welding

Before welding the actual roof membrane, a test weld must be carried out to check the settings of the hand welder and / or the automatic welding machine. The test weld must be also carried out to check local site conditions during a working day.

Hand welding carried out in three steps

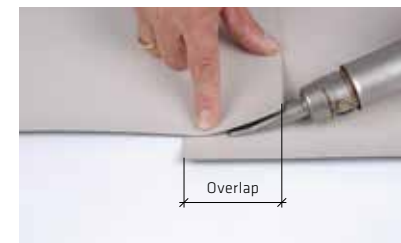

1. Spot weld overlap area must be clean and dry.

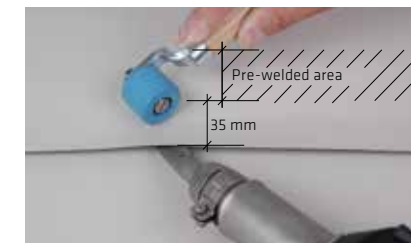

2. Pre-weld the rear overlap area that a 35 mm opening remains.

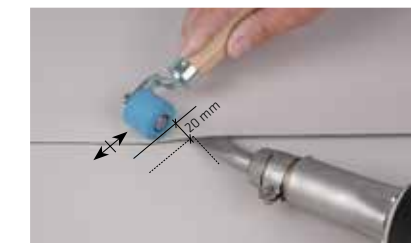

3. Final weld the 35 mm opening area. Roll the pressure roller fully across the seam.

T- and cross joints

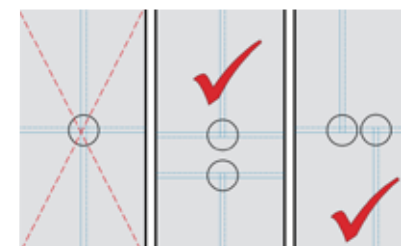

Welds at transverse joints. By proper arrangement of Sarnafil® TG / TS, all seams can be reduced to straight welded seams and transverse joint (T-joint). Cross joints are to be avoided.



To achieve proper welding, all transverse joints of all Sarnafil® TG / TS thickness, for manual and automatic welding have to be chamfered.



Weld the membrane over the chamfered area.

Seam check after welding



All seams must be checked after they have completely cooled by contractor according to Sarnafil® TG / TS application manual.

BASICS

PERIMETER SECUREMENT

At all upstands and penetrations wider than 50 cm Sarnafil® T membrane must be secured with Sarnabar® fastening profile either to the horizontal or vertical surface. The number and type of fasteners per linear meter depend on the substrate and the windload (mechanically fastened system). At least four fasteners per meter must be used. The Sarnafil® T Welding Cord secures Sarnafil® T membrane against tearing and peeling due to wind uplift. In the adhered roof system no Sarnafil® T Welding Cord need to be installed.

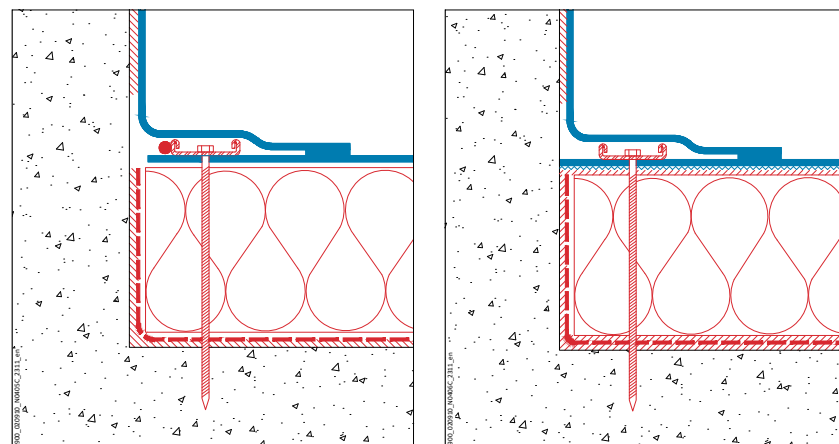
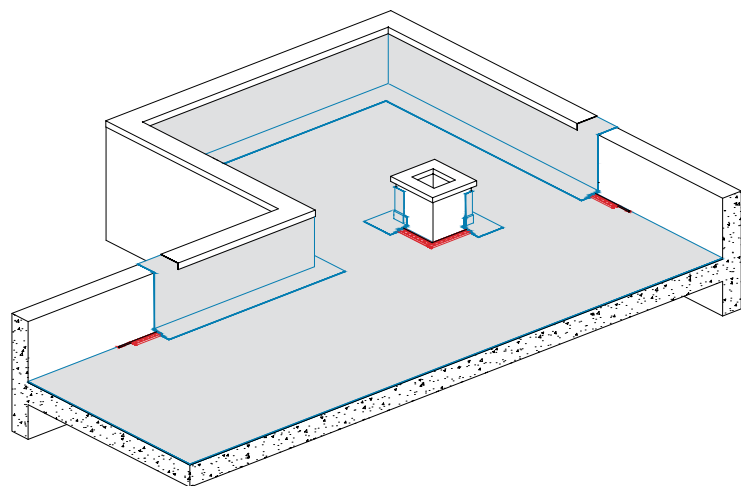

Mechanically fastened and ballasted roof systems – perimeter securements with Sarnafil® T Welding Cord

Adhered roof systems – peel stop without Sarnafil® T Welding Cord

Substrate	Insulation thickness				
	≤ 160 mm	160 – 200 mm	201 – 240 mm	241 – 400 mm	≥ 400 mm
All substrates excl. aerated or light-weight concrete	4 fasteners or tubes / m ²	5 fasteners or tubes / m ²	6 fasteners or tubes / m ²	7 tubes / m ²	special design measures to be taken
Aerated or light-weight concrete	5 fasteners or tubes / m ²	6 fasteners or tubes / m ² and 8 fasteners or tubes / m ² in the corner zone	special design measures to be taken	special design measures to be taken	special design measures to be taken

SARNABAR CONNECTION

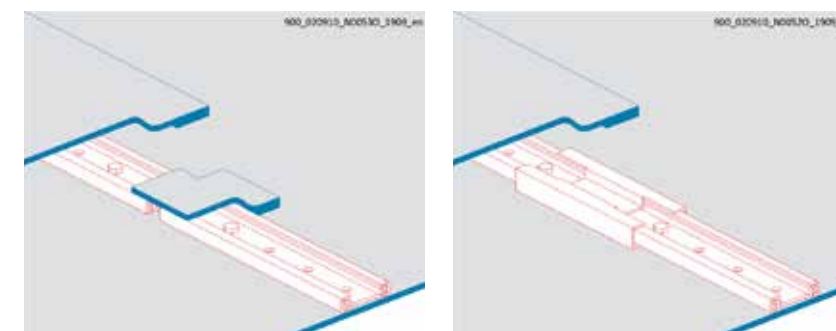

Version 1 – leave a 10 mm clearance between bar ends. Do not fasten in hole nearest bar end. Cover the bar ends with a piece of Sarnafil® T membrane and weld in place.

Version 2 – cover the bar with the Sarnabar® Connection Clip.

PERIMETER FLASHING

Mechanically fastened

A levelling layer must be installed between Sarnafil® T membrane and rough or uneven substrates. Screw the Sarnabar® perimeter securement over the Sarnafil® T membrane at the base of the upstand, either to the vertical or horizontal surface. The number of fasteners per linear meter depend on the substrate and the windload.

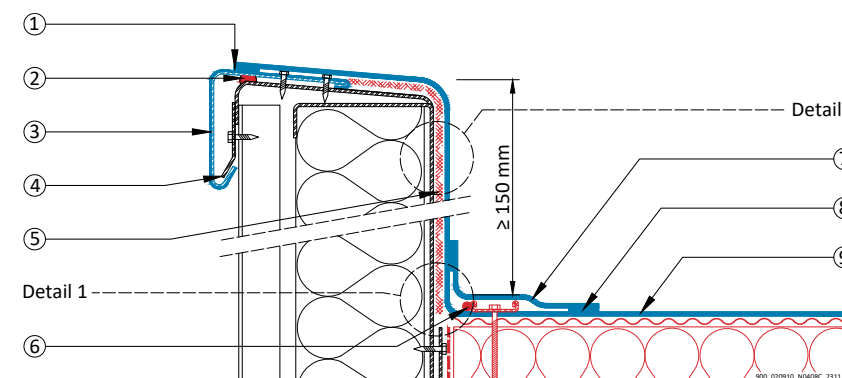

Detail 1
Sarnabar® fastening profile with Sarnafast® SBF-6.0 x L and Sarnafil® T Welding Cord for perimeter securement, vertical installation (alternative)

Detail 2
Additional fastening for parapets ≥ 800 mm height

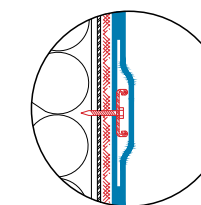
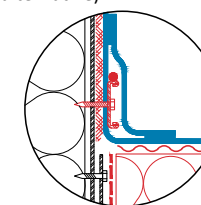

- 1 Hot-air weld
- 2 S-Sealing Tape 10/10
- 3 Sarnafil® T Metal Sheet
- 4 Metal clip
- 5 S-Felt A-300 or Sikaplan® W Felt 500 PP or S-Felt S-800 or S-Felt T-300, levelling and protection layer

- 6 Sarnabar® fastening profile with Sarnafast® fastener and Sarnafil® T Welding Cord
- 7 Sarnafil® T membrane cover strip
- 8 Hot-air weld
- 9 Sarnafil® T membrane

BASICS

PERIMETER FLASHING

Fully adhered

Perimeter flashings are formed using strips of Sarnafil® T membrane. The flashing strips are to be fully adhered with Sarnacol® T-660 adhesive to the substrate and welded to the field sheet. The substrate must be free of ridges, and the flashing must be attached with a good adhesive bond. Form corners, mitres and curved details on site or weld prefabricated Sarnafil® T pieces to the membrane.

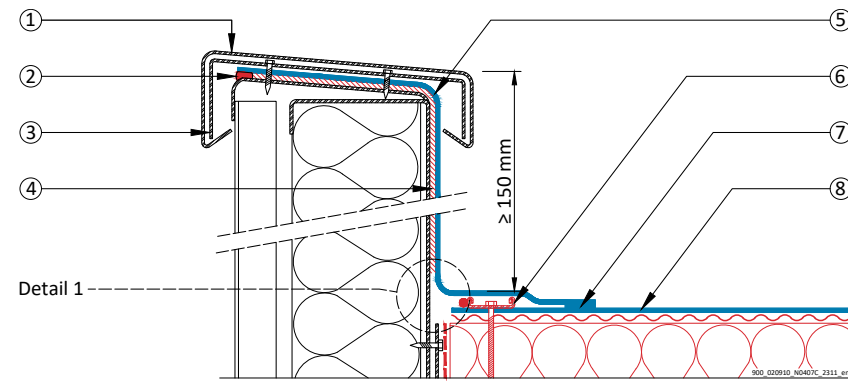

Detail 1
Sarnabar® fastening profile with Sarnafast® SBF-6.0 x L and Sarnafil® T Welding Cord for perimeter securement

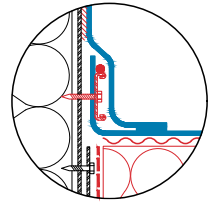

- | | |
|--------------------------------|---|
| 1 Metal capping | 6 Sarnabar® fastening profile with Sarnafast® fastener and Sarnafil® T Welding Cord |
| 2 S-Sealing Tape 10/10 | 7 Hot-air weld |
| 3 Metal clip | 8 Sarnafil® T membrane |
| 4 Sarnacol® T-660 adhesive | |
| 5 Sarnafil® T membrane adhered | |

PERIMETER FLASHING

Tape Adhered

Perimeter flashings are formed using strips of Sarnafil® T membrane. The flashing strips are to be adhered with strips of SikaRoof® Tape P to the substrate and welded to the field sheet. When applying SikaRoof® Tape P, the substrate must be dry, stable, clean and free of dust and grease.

Maximal perimeter height 300 mm.

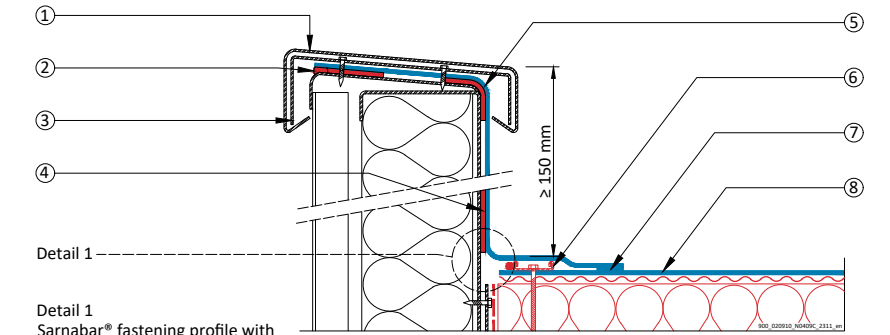

Detail 1
Sarnabar® fastening profile with Sarnafast® SBF-6.0 x L and Sarnafil® T Welding Cord for perimeter securement, vertical installation (alternative)

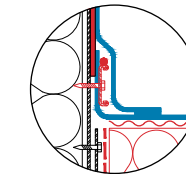

- | | |
|--------------------------------|---|
| 1 Metal capping | 6 Sarnabar® fastening profile with Sarnafast® fastener and Sarnafil® T Welding Cord |
| 2 S-Sealing Tape 10/10 | 7 Hot-air weld |
| 3 Metal clip | 8 Sarnafil® T membrane |
| 4 SikaRoof® Tape P | |
| 5 Sarnafil® T membrane adhered | |

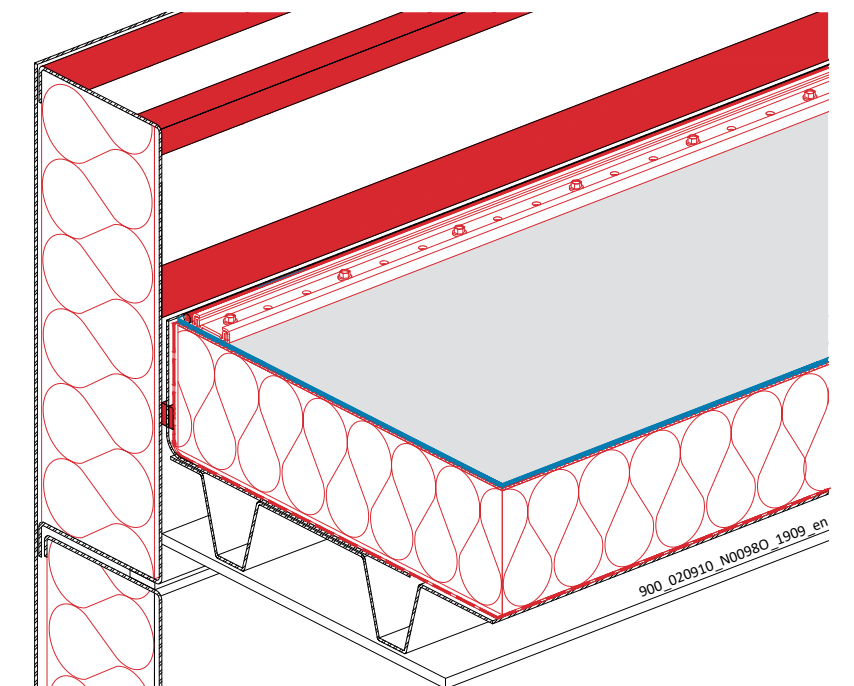

BASICS

PERIMETER FLASHING

Roof Trim

S-Sealing Tape 10/10 should be placed between the Sarnafil® T Metal Sheet flashing and the substrate to prevent penetration of wind-driven water.

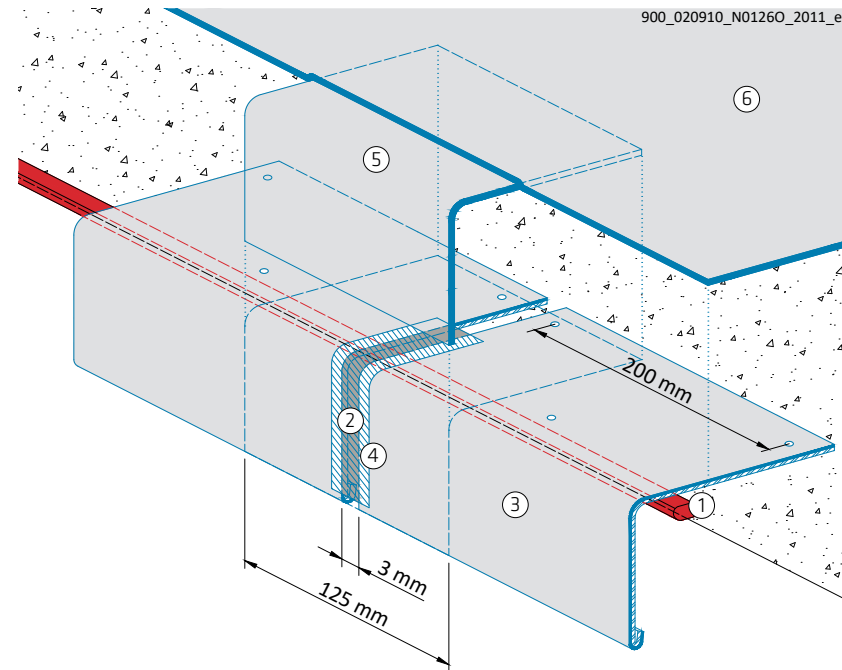

- | | |
|---------------------------|------------------------------|
| 1 S-Sealing Tape 10/10 | 4 Tape to avoid full weld |
| 2 Connection plate | 5 Sarnafil® T - 125 mm strip |
| 3 Sarnafil® T Metal Sheet | 6 Sarnafil® T membrane |

UPSTAND FLASHING

To achieve good adhesion, apply primer to both surfaces (metal counter flashing or sheet, and masonry or plaster). At the top metal counter flashing or sheet, always install closed-cell material as backing rod before applying the Sarnaplast®-2235 or Sikaflex®-11 FC Pureform®.

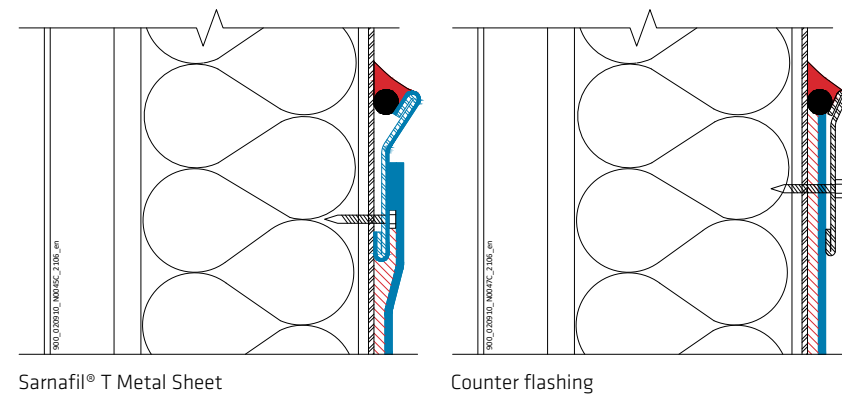

DETAILING WITH Sikalastic®-625 N

INTRODUCTION

Detailing utilizing Sikalastic® systems is an exceptionally efficient method of protecting difficult details in combination with Sarnafil® FPO membranes by using Sikalastic®-625 N first layer (base coat) in combination with Sika® Reemat Premium or Sika® Glass Fibre Fleece Premium embedded and Sikalastic®-625 N second layer (top coat).

Sikalastic® systems, composed of Sikalastic®-625 N base coat and Sikalastic®-625 N top coat and, is the next generation of Sikalastic® LAM Systems for roofing and balcony / terraces applications, with reduced VOC content, using the Sika patented i-Cure® hardener for lower odor development during, as well as after, the curing process. One of the main issues facing the use of liquids in various situations still relates to the odor emitted during and for a short period after application.

Sikalastic® systems is using unique products made of the Sika patented i-Cure hardener technology, which has been developed specifically for use in highly sensitive site areas, such as hospitals, schools, food and pharma industry, etc. Sikalastic®-625 N is a membrane from the Sikalastic® range that cures to provide completely seamless waterproof protection which is followed by the application of the Sikalastic®-625 N to complete the joint-less, low odor, liquid applied roofing system. Its liquid application means it can be easily applied to all complex detail areas, and because it is completely cold applied there is no requirement for any heat or naked flame on the roof.

- Sika patented i-Cure technology
- One component products – no mixing, easy and ready to use
- UV resistant – Highly reflective (~RAL 9016) and resistant to yellowing
- Cold applied base coat and top coat – requires no heat or flame
- Seamless roof waterproofing membrane
- Base coat compatible with Sika® Reemat Premium or Sika® Glass Fibre Fleece Premium easy to detail
- Fast curing products – free from resin damage almost immediately on application
- High elastic and crack-bridging – retains flexibility even at low temperatures
- Easily re-coated when needed – no stripping required
- Good adhesion to most substrates with the suitable primer
- Vapour permeable – allows substrate to breathe
- Strong resistance to common atmospheric chemicals



SYSTEM DESCRIPTION - BUILD-UP ON Sarnafil® T roof waterproofing membrane

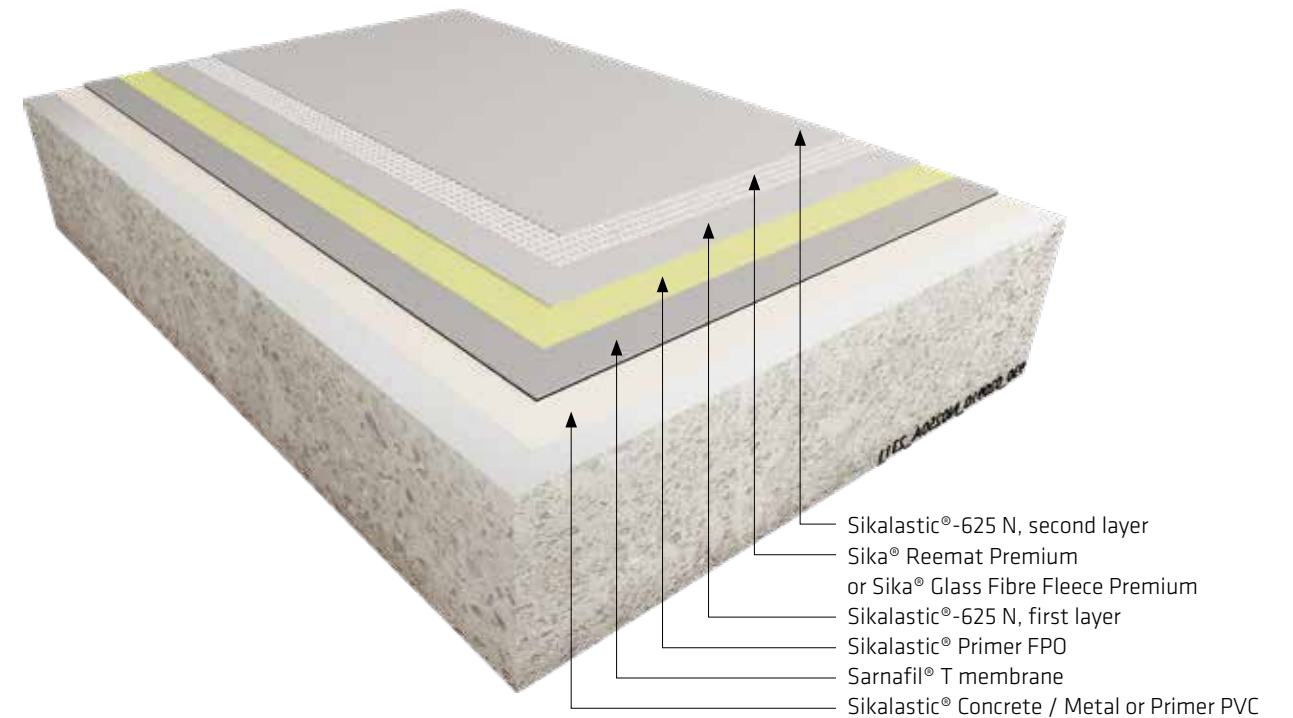

UPSTAND - METAL WALL ELEMENT

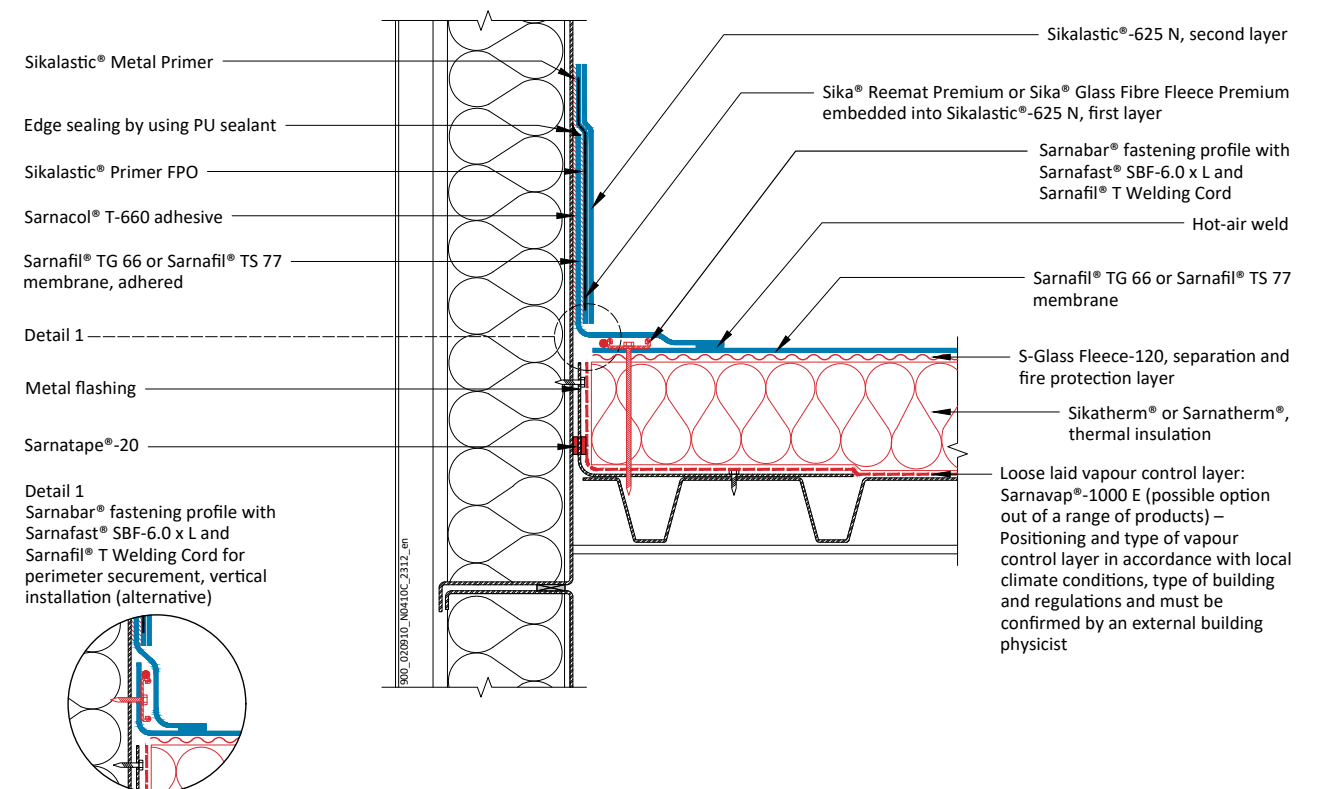

DETAILING WITH Sikalastic®-625 N

UPSTAND - CONCRETE WALL

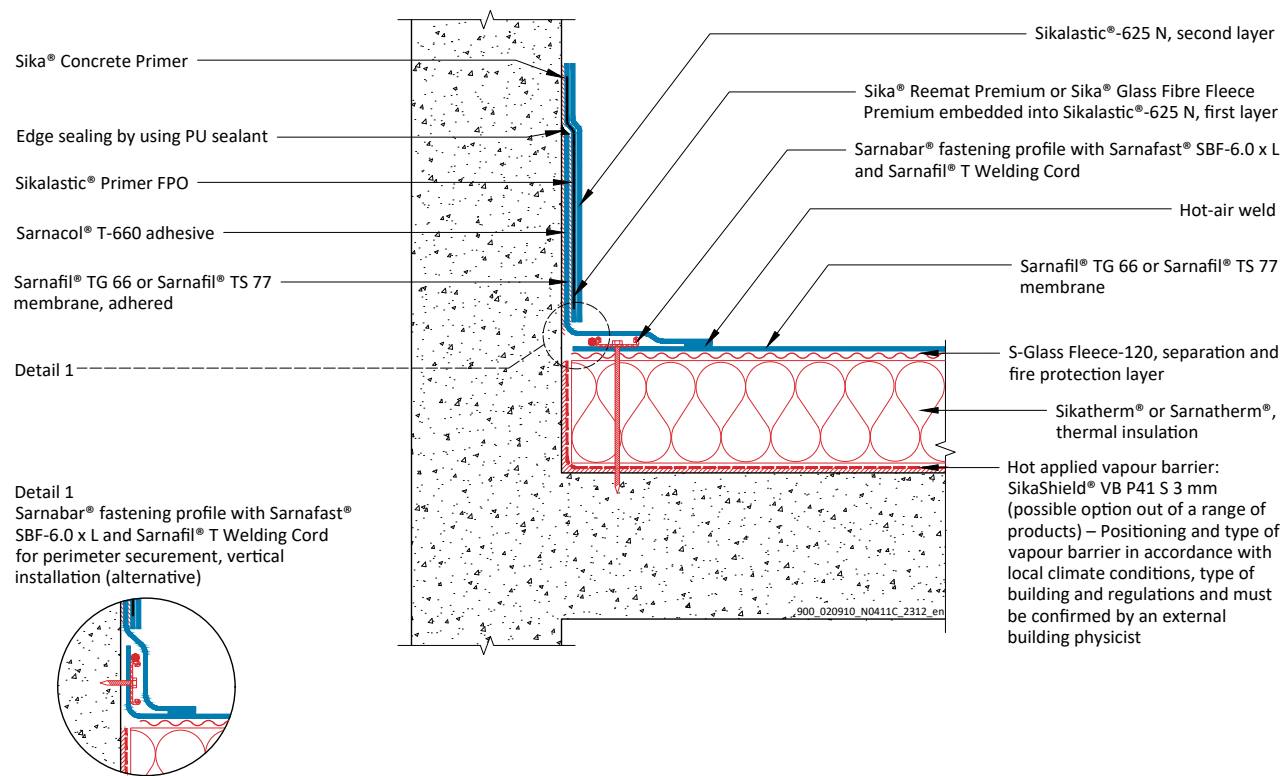

UPSTAND - WINDOW DOOR FRAME

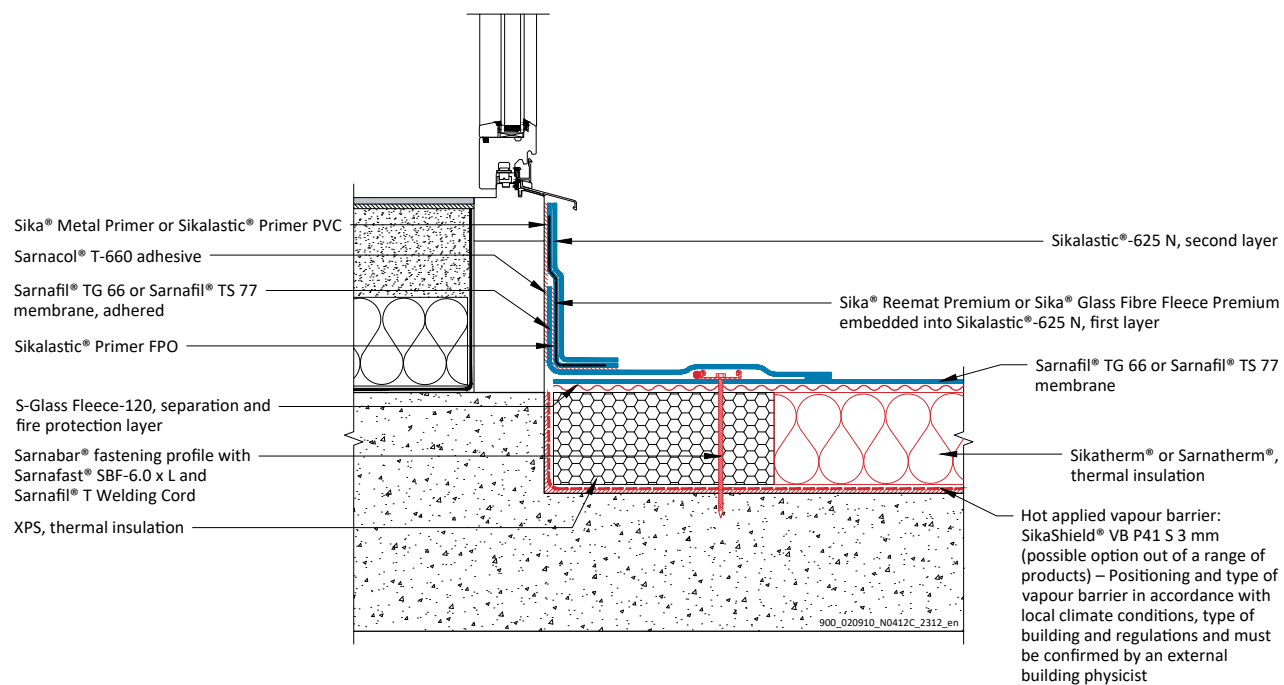

Sikalastic®-625 N PRODUCTS

Sikalastic®-625 N



DESCRIPTION

Sikalastic®-625 N is a 1-part polyurethane, reinforced, cold-applied liquid membrane. It provides a flexible, seamless waterproofing solution using Sika's unique i-Cure technology.

USES

Designed for the following waterproofing applications:
 Roof waterproofing for new construction and refurbishment projects
 ■ Unreinforced waterproofing system for profiled metal roofs
 ■ Reinforced waterproofing of flat and pitched roof structures, communal walkways, podium decks and roof terraces exposed to pedestrian traffic
 ■ Waterproofing structures with numerous details such as penetrations, drains, roof lights and complex geometry
 ■ Waterproofing existing substrates of concrete, bituminous felt and coatings, brick, stone, asbestos cement, metal, wood, unglazed ceramic tiles
 ■ For exterior use only
 ■ Sikalastic®-625 N may only be used by experienced professionals

CHARACTERISTICS / ADVANTAGES

- 1-Part ready to use
- Low maintenance
- Seamless
- Easy and quick application by brush, roller or spray
- Suitable for trafficable areas
- Vapour permeable
- Good UV resistance and colour stability
- Retains flexibility at low temperatures
- Cold applied – requires no heat or flame
- Moisture triggered technology develops early rain resistance
- Good elastic properties
- Low temperature application > +2°C

COLOR

Note: Applied colors selected from color charts will be approximate, for color matching; apply color sample and confirm selected color under real lighting conditions.
 ■ Slate grey (~RAL 7015)
 ■ Light grey (~RAL 7035)

Accessory product – no declaration under EN 13956.



Sika® Reemat Premium or Sika® Glass Fibre Fleece Premium



DESCRIPTION

Sika® Reemat Premium or Sika® Glass Fibre Fleece Premium is a glass fibre reinforcement mat for use with Sikalastic® Liquid Applied Membrane (LAM) roofing systems.

USES

Reinforcement for Sikalastic® Liquid Applied Membrane (LAM) roofing systems.

CHARACTERISTICS / ADVANTAGES

- Easy and quick application
- Easy to adjust to complicated details
- Ensures the correct thickness of the base coat
- Improves crack-bridging properties of the system
- Improves mechanical properties of the system

TECHNICAL INFORMATION

Sika® Reemat Premium
 Length: 90.00 m
 Width: 0.30 and 1.25 m
 Weight: 225 g/m²

Sika® Glas Fibre Fleece Premium
 Length: 50.00 mm
 Width: 0.15, 0.20, 0.25 and 1.00 m
 Weight: 225 g/m²

APPEARANCE / COLOR

Composition random glass fibre strand matting in white

Sikalastic®-625 N PRODUCTS

Sikalastic® Metal Primer



DESCRIPTION

Sikalastic® Metal Primer is a two-component, anticorrosive primer for exposed metal substrates and blocking primer over bituminous felts and coatings.

USES

Versatile and anti-corrosive primer on metal substrates for use with:

- Sikalastic® Liquid Applied Membrane (LAM) roofing systems. Barrier against migration of volatile bitumen or plasticizer migration

CHARACTERISTICS / ADVANTAGES

- Fast curing, overcoat possible after 6 hours
- Corrosion protection in industrial and marine environments
- Easy application by brush or roller
- Enhances adhesion to a broad range of metallic substrates
- Protects against migration of volatile bitumen or plasticizers

Sika® Concrete Primer



DESCRIPTION

Sika® Concrete Primer is a 2-part, polyurea / polyurethane-hybrid primer for cementitious substrates. The rapid curing performance allows overcoating of Sikalastic® Liquid Applied Membrane (LAM) roofing systems after 30 minutes.

USES

Primer on cementitious substrates for use with exterior applications of:

- Sikalastic® Liquid Applied Membrane (LAM) roofing systems

CHARACTERISTICS / ADVANTAGES

- Very good bond strength to substrate
- Reduces the likelihood of outgassing from susceptible substrates
- Helps to stabilise substrates
- Easy to apply
- Can be filled with quartz sand and used as a scratchcoat

Sikalastic® Primer PVC



DESCRIPTION

Sikalastic® Primer PVC is a one-component, clear red polyurethane primer for consistent and durable adhesion between Sikalastic® Liquid Applied Membrane (LAM) roofing systems and PVC substrates.

USES

Sikalastic® Primer PVC may only be used by experienced professionals. Primer for detailing works with Sikalastic® Liquid Applied Membrane. Suitable substrates, new installations (less than 3 years old).

CHARACTERISTICS / ADVANTAGES

- One-component - easy and ready to use
- Enhance adhesion to PVC substrates
- Fast curing - overcoating possible after max 2 hours

Sikalastic® Primer FPO



DESCRIPTION

Sikalastic® Primer FPO is a one-component, transparent, slightly yellowing, solvent-based synthetic polymer primer, specifically formulated to Sikalastic® Liquid Applied Membrane (LAM) roofing systems onto FPO membranes.

USES

Sikalastic® Primer FPO may only be used by experienced professionals. Primer for detailing works with Sikalastic® Liquid

Applied Membrane (LAM) roofing systems on Sarnafil® AT or Sarnafil AT FSA P membranes.

CHARACTERISTICS / ADVANTAGES

- One-component - easy and ready to use
- Enhance adhesion to Sarnafil® FPO Membranes
- Fast curing-overcoating possible after max 1 hour

Sika®Joint Tape SA



DESCRIPTION

Self-adhering polymeric rubberized tape with plastic release liner on underside and woven polyester facer on top side. Enhances the strength and durability of Sikalastic® roofing and waterproofing membranes at joints and angle changes.

USES

- Reinforcement of joints between cover boards on insulation
- Reinforcement of joints between plywood deck panels
- Reinforcement of joints and seams in metal roofing
- Stripping of metal flanges to structural deck

CHARACTERISTICS / ADVANTAGES

- Self-adhering, no primer required for most applications
- Fleece facer allows positive resin / coating bond
- Stretches with membrane to accommodate thermal and structural movement
- Imparts additional strength and durability
- Conforms to substrate contours and flashing conditions

TECHNICAL INFORMATION

Length: 15.40 m
Width: 76.2 and 152.4 mm
Thickness: 0.77 mm

APPEARANCE / COLOR

Off-white fleece top surface, black bottom surface

Sika® Flexitape Heavy



DESCRIPTION

Sika® Flexitape Heavy is a flexible knitted polyamide used as localised reinforcement with Sikalastic® Liquid Applied Membrane systems. Unlike conventional scrims, it is readily capable of stretching within the membrane to accommodate a high degree of thermal and structural movement.

USES

- Localised reinforcement for Sikalastic® systems used over joints or cracks liable to movement and for bridging gaps between substrates
- Localised reinforcement used in the construction of expansion joints
- For new construction and refurbishment projects

CHARACTERISTICS / ADVANTAGES

- Easy and quick application
- Follows surface contours and is easy to adjust to complicated details
- Enhance the crack-bridging properties of the system
- Enhance mechanical properties of the system

TECHNICAL INFORMATION

Length: 50.00 m
Width: 75 and 150 mm

APPEARANCE / COLOR

White

Sikalastic® Flexistrip



DESCRIPTION

Sikalastic® Flexistrip is a preformed strip sealant reel on a paper release liner for use with Sikalastic® membrane systems.

USES

- Localised bond breaker for Sikalastic® systems used over bolt heads or butt joints of metal sheets liable to movement. For new construction and refurbishment projects.

CHARACTERISTICS / ADVANTAGES

- Easy and quick application
- Self-adhering

TECHNICAL INFORMATION

Length: 15.00 m
Width: 50 mm

APPEARANCE / COLOR

Off-white

FALL ARREST SYSTEM

INTRODUCTION

Working on roof areas is considered to be one of the most dangerous activities on a construction site for both new and refurbishment projects. It can also be necessary to carry out essential maintenance or repair works on flat roofs during bad weather conditions, including for example: the removal of drain blockages, repairing dome lights and removing snow accumulation. All flat roof working activities are situations with a high risk of roof falls, where the danger can be either, falling at the flat roof edge or actually falling through openings or the roof itself. These potential hazard combinations should already be respected and considered during the design and planning phase of a project.

Where the building structure or situation (e.g. with parapets, handrails etc.) cannot prevent a roof fall – a fall back system needs to be designed according to the following basic principles:

If the parapet height is < 1.00 m – the flat roof area needs to be equipped with a fall arrest system.

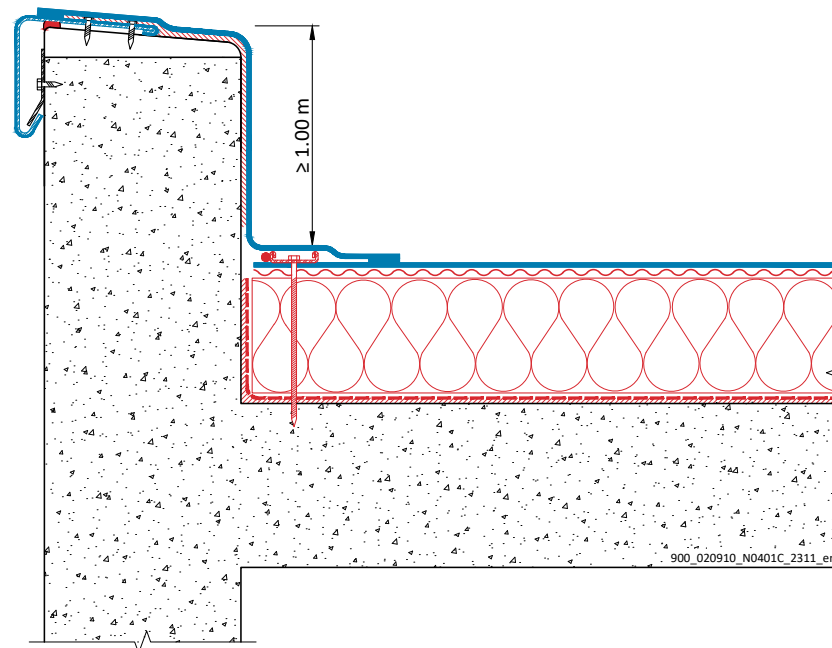

For projects with a cable system or a guard rail system you might directly get in contact with ABS Safety Systems.

<https://www.absturzschutz.de>



MECHANICALLY FASTENED ROOF SYSTEM - SPOT FASTENING

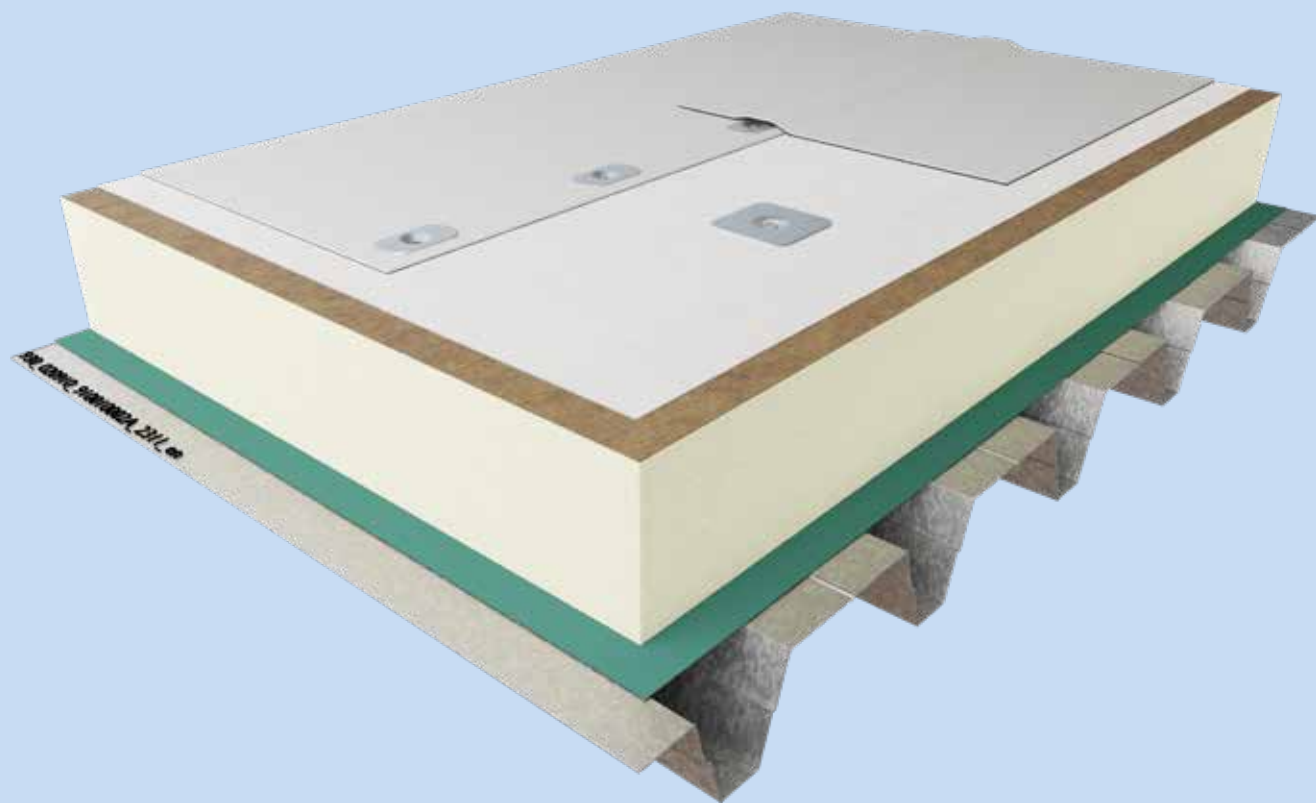

SYSTEM DESCRIPTION

Exposed roofs with Sarnafil® TS 77 roof waterproofing membranes can be mechanically fastened using the Sarnafast® Spot Fastening System. These lightweight systems meet all the requirements for modern flat roofing.

CHARACTERISTICS / ADVANTAGES

- Mechanically fastened roofs are the most cost efficient for exposed roofing applications
- The fastest installation speed is achieved with mechanically fastening
- Sarnafil® TS 77 roof waterproofing membrane has special polyester reinforcement, enabling high wind load resistance
- Installation is almost not weather dependent

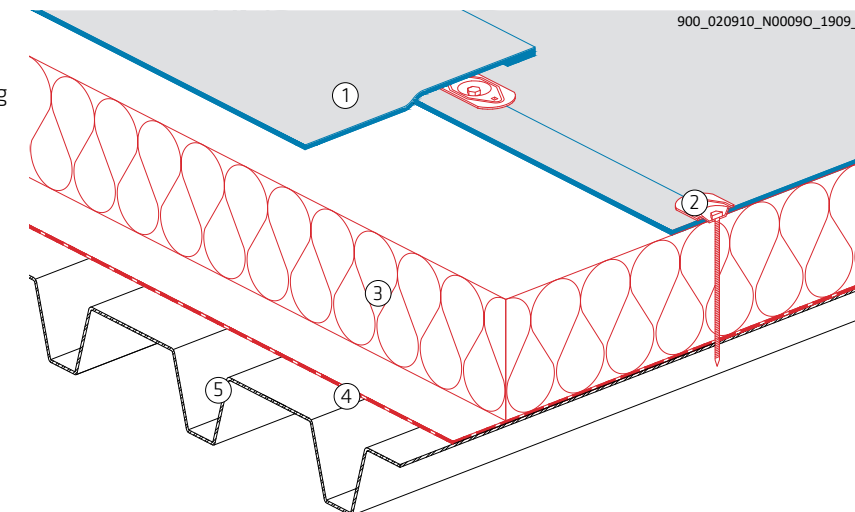

- | | |
|------------------------------------|-----------------------------------|
| 1 Sarnafil® TS 77 membrane | 4 Vapour- control layer / barrier |
| 2 Sarnafast® spot fastening system | 5 Roof deck |
| 3 Thermal insulation | |

SYSTEM DESCRIPTION

Fire separation- / Protection layer

A separation- / fire protection layer S-Glass Fleece 120 g/m² to be installed above thermal insulation where it is required by fire regulation.

Thermal insulation fastening

Before the Sarnafil® TS 77 roof waterproofing membrane is installed, the insulation boards must be secured to the roof deck using appropriate Sarnafast® fasteners and insulation washers / tubes according to insulation manufactures instructions.

Types of spot fastening systems

Sarnafast®
Tube Spot Fastening System
using polyamide tubes

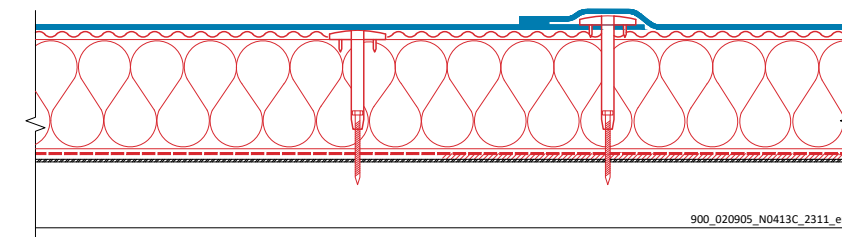

Sarnafast®
Spot Fastening System
using metal washers

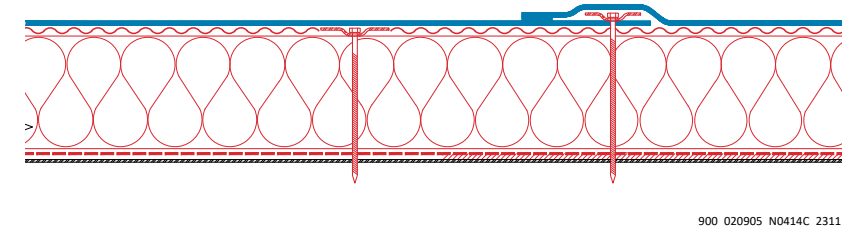

MECHANICALLY FASTENED ROOF SYSTEM - SPOT FASTENING

Application of spot fastening systems

Sarnafil® TS 77 is fastened using Sarnafast® fasteners and washers / tubes along the marked line 35 mm from the edge of the membrane. On trapezoidal steel decks the membrane shall be fastened 90° to the direction to the steel corrugations.

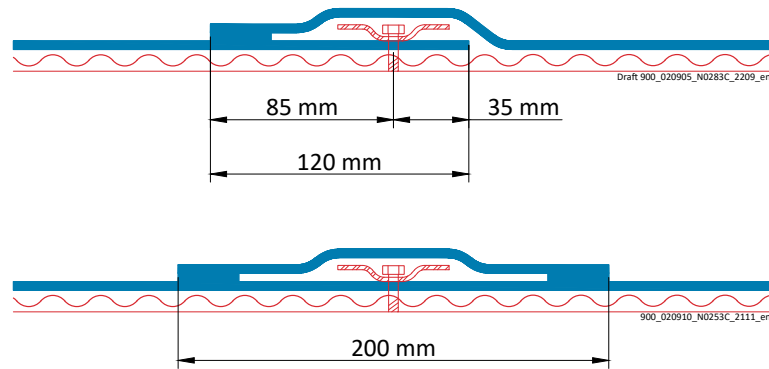

Where additional fastening is required, Sarnafast® fasteners and washers / tubes are installed through the roof waterproofing membrane (intermediate fastening). Cover the rows of Sarnafast® fastening system with a 200 mm wide membrane cover strip and weld both sides.

Planning and layout

The spacing and numbers of fasteners and washers depend on the following:

- Building regulations and standards
- Wind uplift forces
- Elongation limit of the roof waterproofing membrane
- Pullout strength of the fasteners
- Available points of attachments to the deck
- Type and quality of roof deck

Sika determines the fastening pattern and calculates the fastener spacing depending on the substrate and the design load of the relevant fastener for the local situation of project (Wind Load Calculation page).

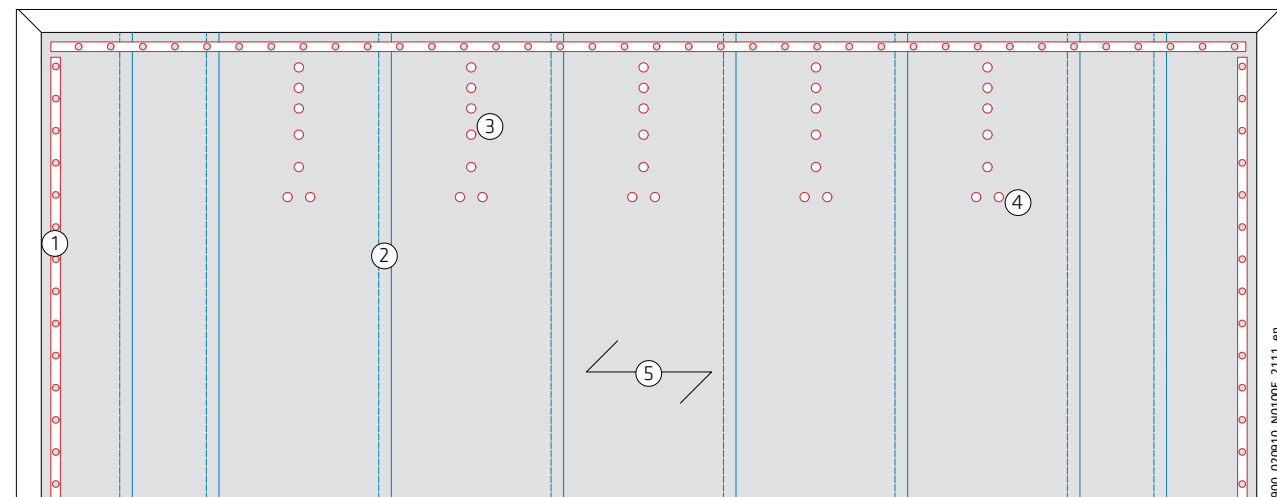

- 1 Perimeter Sarnabar® fastening profile with Sarnafil® T Welding Cord
- 2 Sarnafast® spot fastening system along the edge of roof waterproofing membrane
- 3 Sarnafast® spot fastening system with cover strip
- 4 Row termination with two Sarnafast® fasteners and washers / tubes or Universal Row / Load Distribution Plate and at least two Sarnafast® fasteners and Sarnabar® tubes
- 5 Direction of metal deck ribs

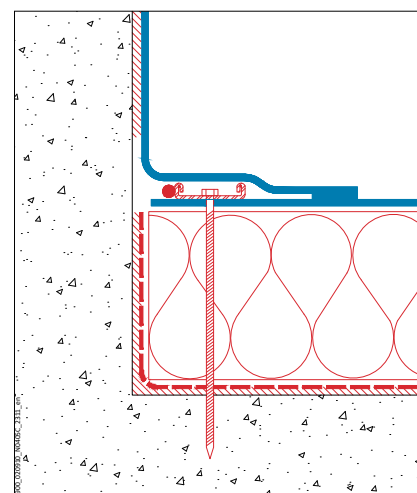

Sarnabar® fastening profile perimeter securement

Row termination of intermediate fastening with two Sarnafast® fasteners and washers / tubes and 200 mm wide cover strip.

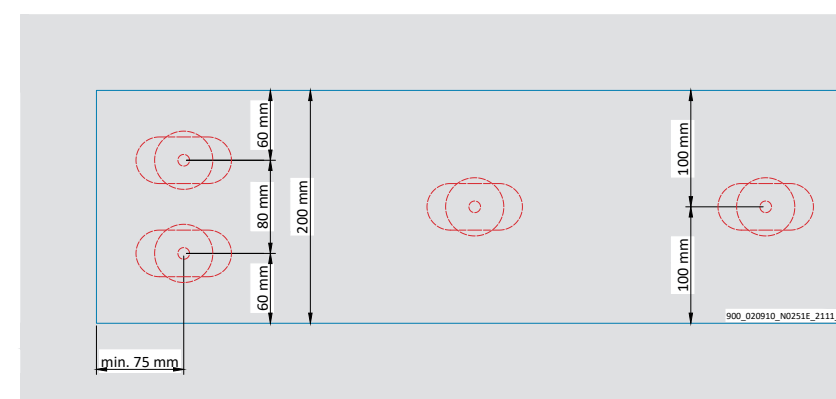

Row termination of intermediate fastening with Universal Row / Load Distribution Plate and at least two Sarnafast® fasteners and Sarnabar® tubes and 200 mm wide cover strip.

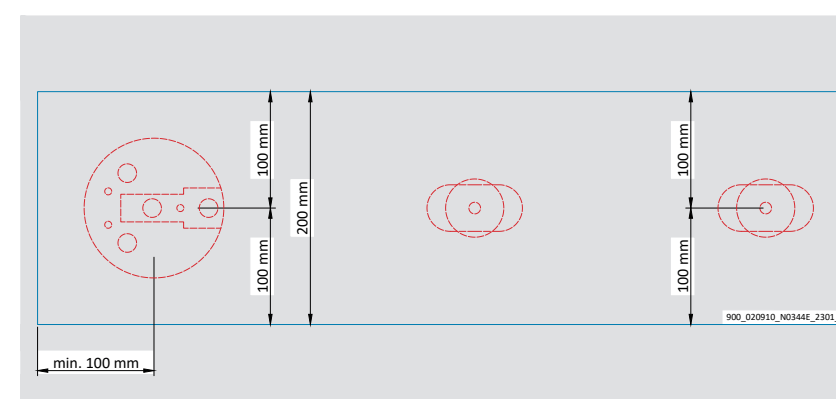

MECHANICALLY FASTENED ROOF SYSTEM - INDUCTION WELDING

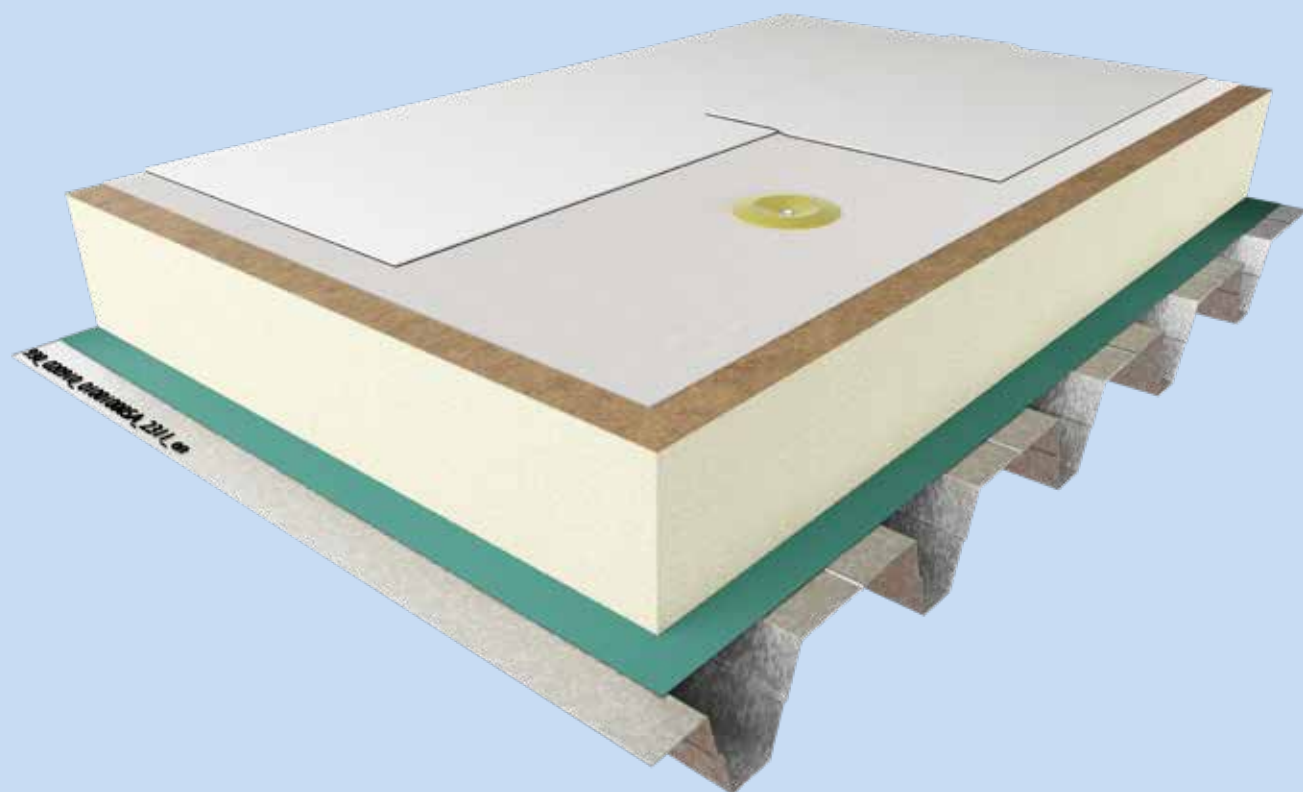

SYSTEM DESCRIPTION

Exposed roofs with Sarnafil® TS 77 roof waterproofing membranes can be mechanically fastened using SikaRoof® Induction Welding System. This field fastening system uses induction technology and offers a non-penetrating solution.

CHARACTERISTICS / ADVANTAGES

(In addition to the classic spot fastening system)

- No thermal insulation fastener required
- Fastening independent of membrane joints
- Only one membrane width required



Video:
SikaRoof® Induction Welding System

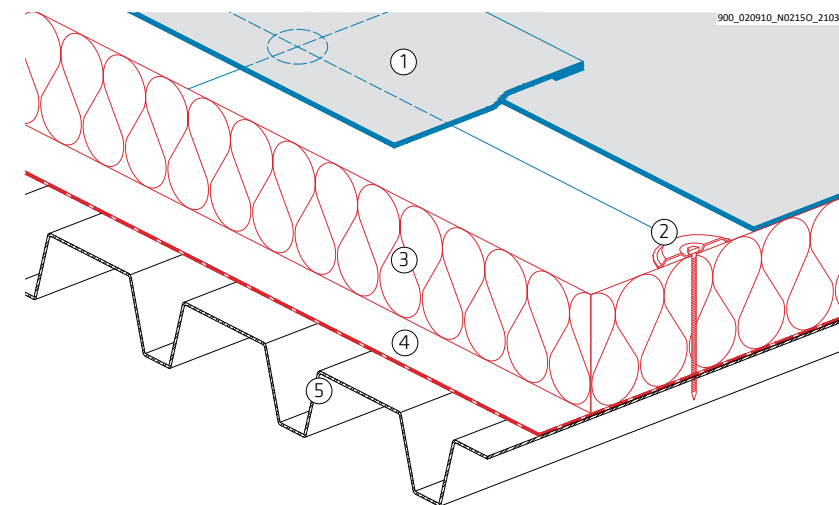

- | | |
|--------------------------------------|-----------------------------------|
| 1 Sarnafil® TS 77 membrane | 4 Vapour- control layer / barrier |
| 2 SikaRoof® induction welding system | 5 Roof deck |
| 3 Thermal insulation | |

SYSTEM DESCRIPTION

Thermal insulation or deck fastening

Before the Sarnafil® TS 77 roof waterproofing membrane is installed, SikaRoof® Induction Welding System will be fixed into the insulation boards or directly to the roof deck according to the fastening layout.

Fire separation- / Protection layer

A separation- / fire protection layer S-Glass Fleece 120 g/m² to be installed above thermal insulation where it is required by fire regulation.

Types of induction welding systems

SikaRoof® Tube Induction Welding System using polyamide tubes in combination with metal discs

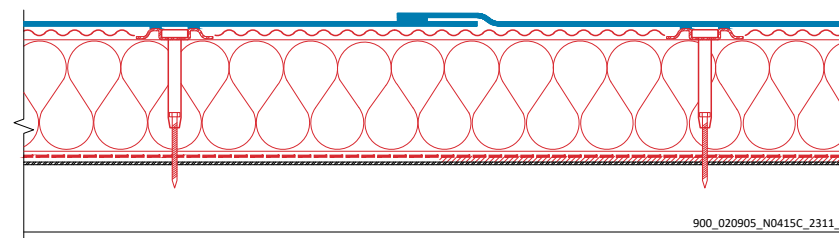

SikaRoof® Induction Welding System using metal discs

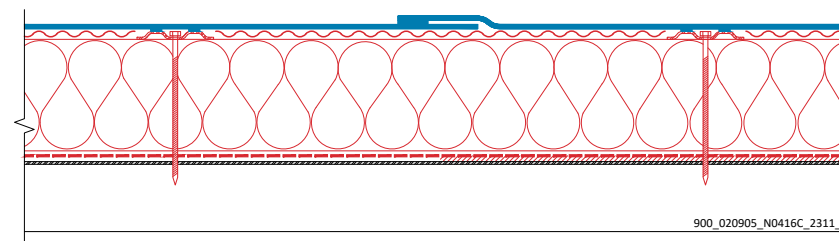

MECHANICALLY FASTENED ROOF SYSTEM - INDUCTION WELDING

Application of induction welding system

Sarnafil® TS 77 membrane is fastened using Sarnafast® fastener and SikaRoof® induction welding discs with or without Sarnabar® tubes. Membrane must be overlapped by 80 mm and hot welded.

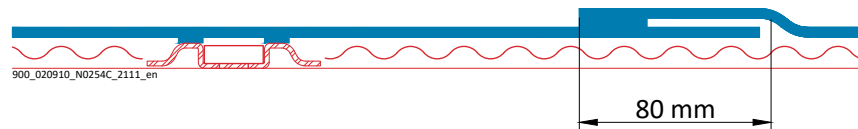

Planning and layout

The spacing and numbers of fasteners and washers depend on the following:

- Building regulations and standards
- Wind uplift forces
- Elongation limit of the roof waterproofing membrane
- Pullout strength of the fasteners
- Available points of attachments to the deck
- Type and quality of roof deck

Sika determines the fastening pattern and calculates the fastener spacing depending on the substrate and the design load of the relevant fastener for the local situation of project (Wind Load Calculation page).

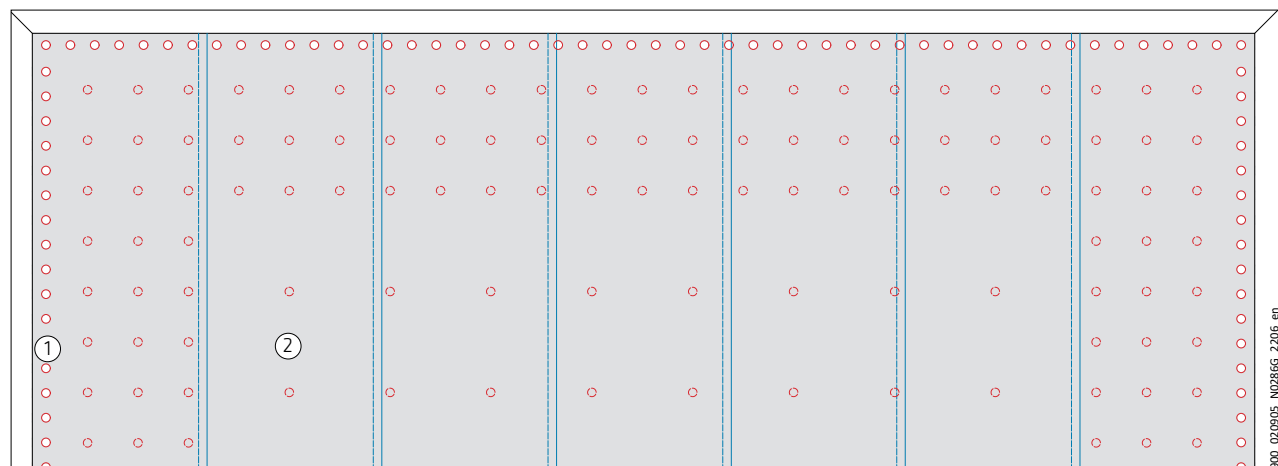

- 1 Sarnabar® fastening profile or SikaRoof® induction welding perimeter securement
- 2 SikaRoof® induction welding system

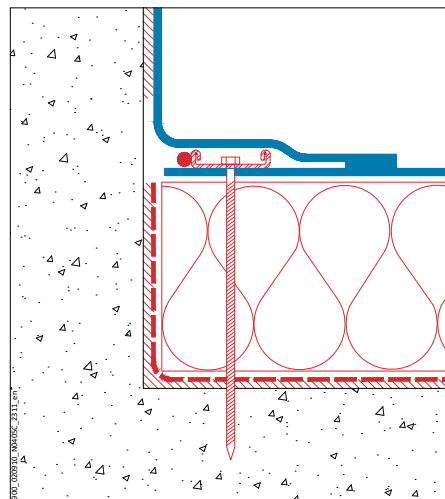

Sarnabar® fastening profile perimeter securement

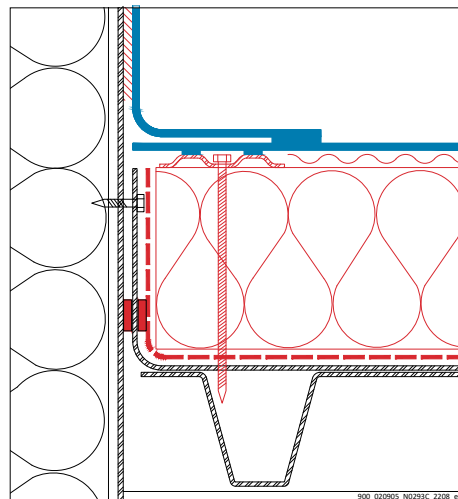

SikaRoof® induction welding perimeter securement

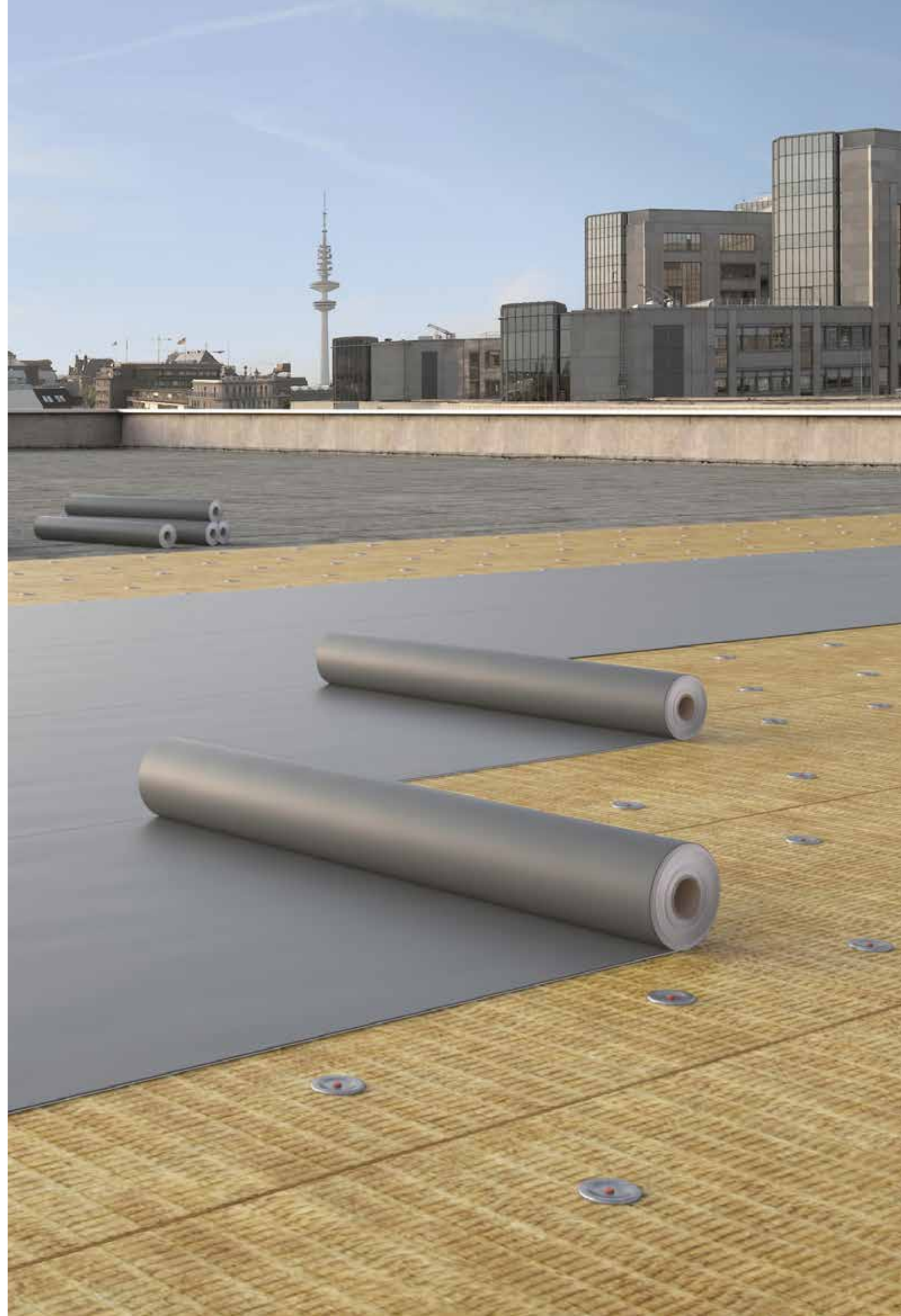

MECHANICALLY FASTENED ROOF SYSTEMS – GENERAL

Sarnafast® Spot Fastening System

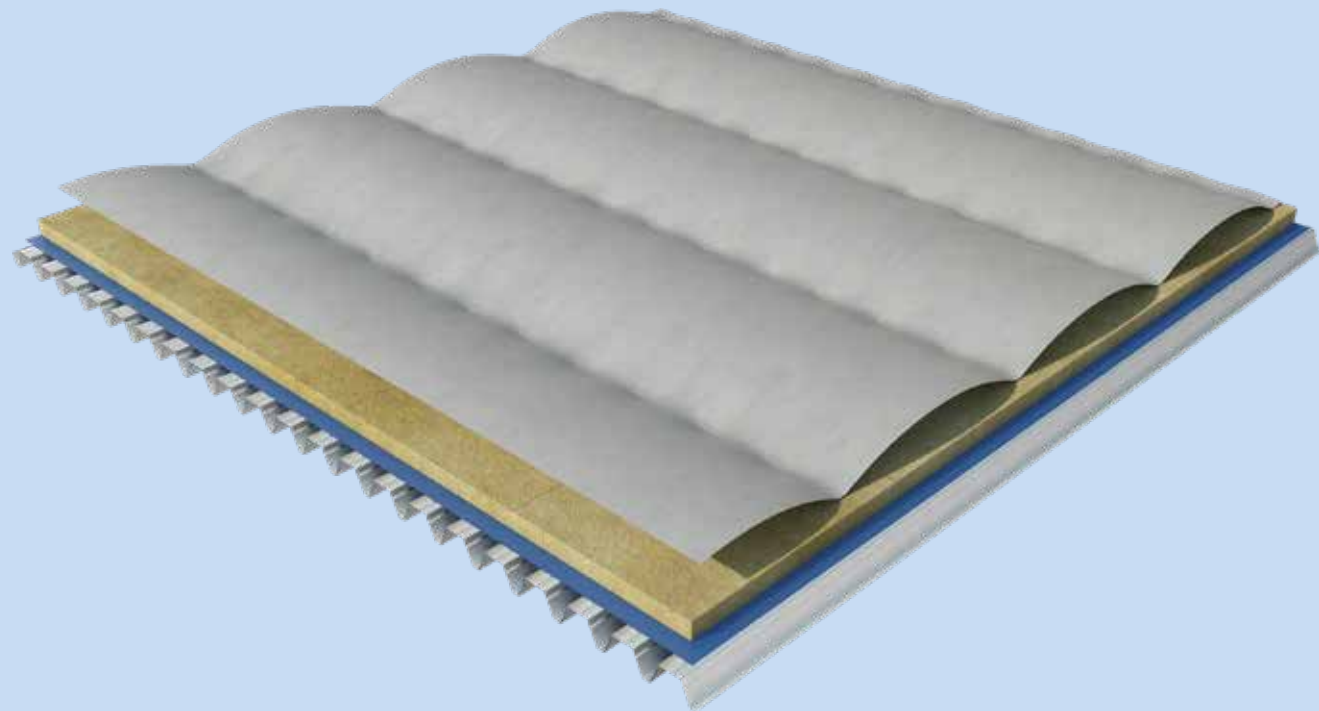

SikaRoof® Induction Welding System

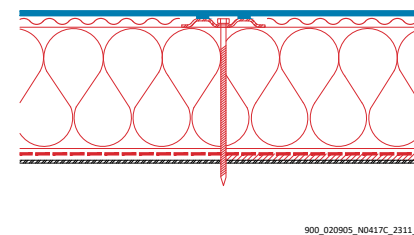
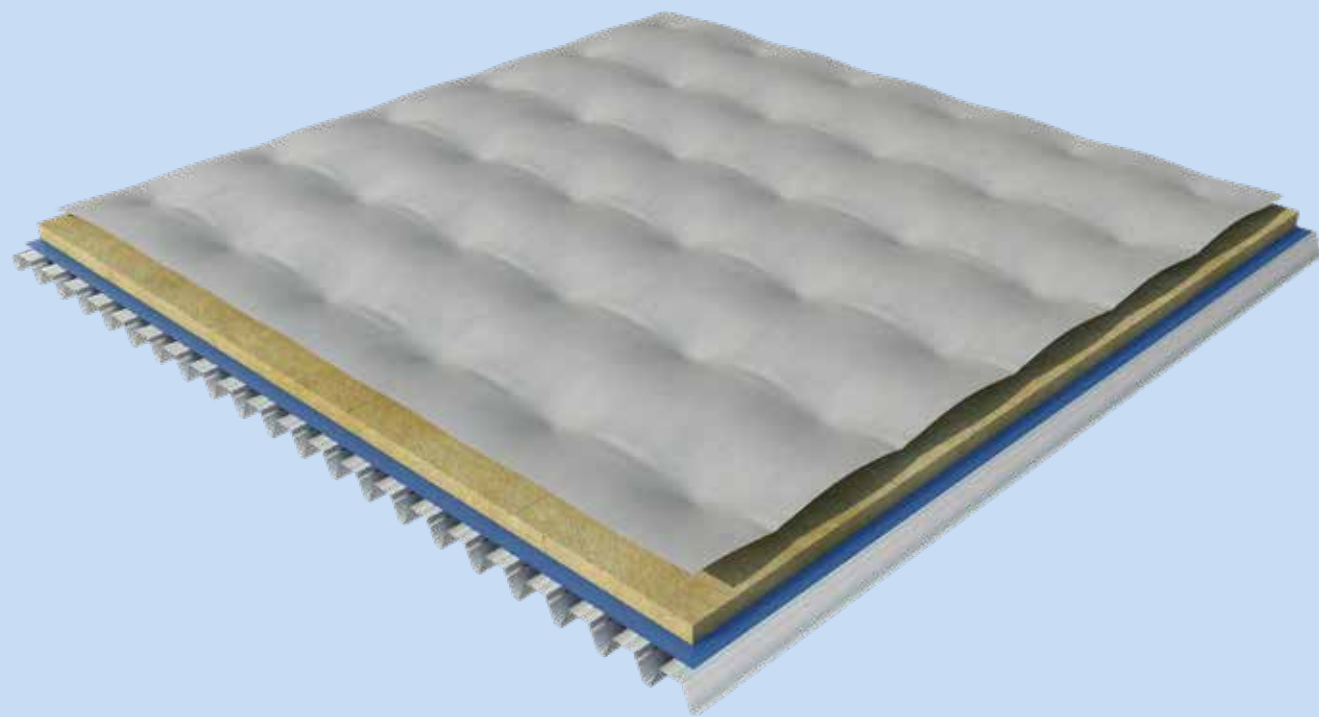

Steel decks

The deck must be galvanized steel with a minimum thickness of 0.63 mm, yield strength of minimum S280 according to EN 10147 or equal. The suitability of the deck must be verified by an architect, structural engineer or other qualified specialist. Orient rows of fasteners perpendicular to the direction of the deck ribbing. The fasteners are self-tapping in decks up to 1.25 mm thick. Thicker decks might require pilot holes. All fasteners must penetrate the top flange of the deck. All fasteners used must be approved by Sika Roofing.

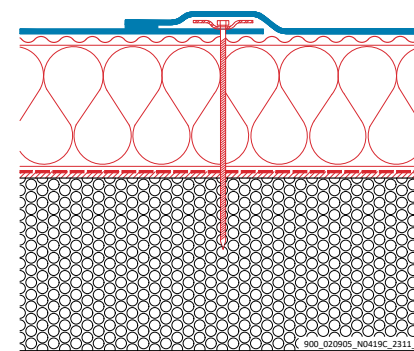

Aerated (cellular, gas) or lightweight concrete decks

All roofing applications over concrete decks require an on-site pullout test. Conduct the test immediately after setting the fastener in order to confirm fastener performance.

Heed the following:

- All fasteners used must be approved by Sika Roofing
- Do not alter the perforation of the bars
- Install fasteners using an electric dynamometric screw driver

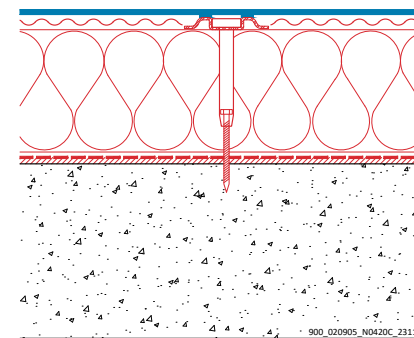

Reinforced, precast or pre-stressed concrete decks

Concrete quality must be at least C20/25.

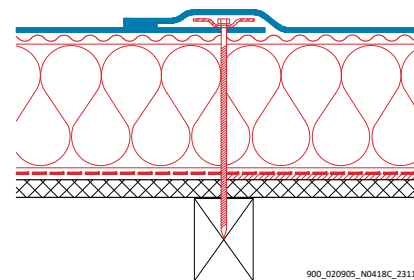

Wood decks

Approved fasteners must be used for fastening roofing to wood decks.

The selection of fastener depends on these factors:

- Quality and thickness of the wood
- Embedment depth and pullout strength
- Type of wood preservative used

Mechanical fastening on wood decks

Material mechanical minimum attachment thickness:

- Plywood / OSB ≥ 22 mm
- Wood planking ≥ 24 mm
- Chipboard not allowed

Plywood decks

Observe local codes and standards regarding application, fastening and fire protection.

Board decks

- Boards should be tongue and grooved
- Only wood treated with aqueous, salt-based preservative may be used
- Sika Roofing accepts no liability for damage to the roof waterproofing membrane caused by insect infestation

MECHANICALLY FASTENED ROOF SYSTEMS – GENERAL

Steel

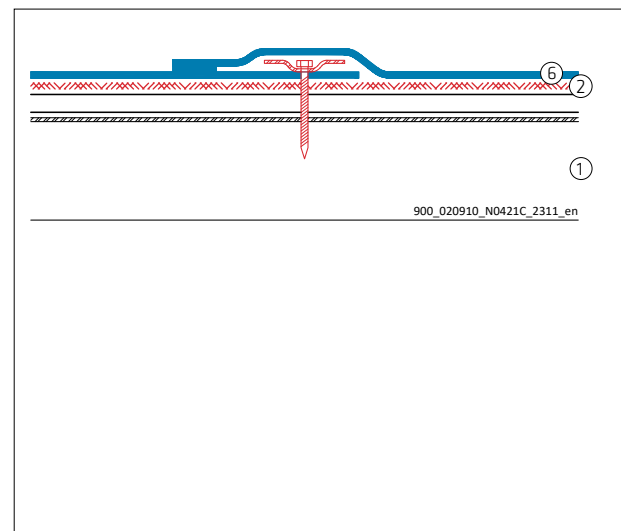
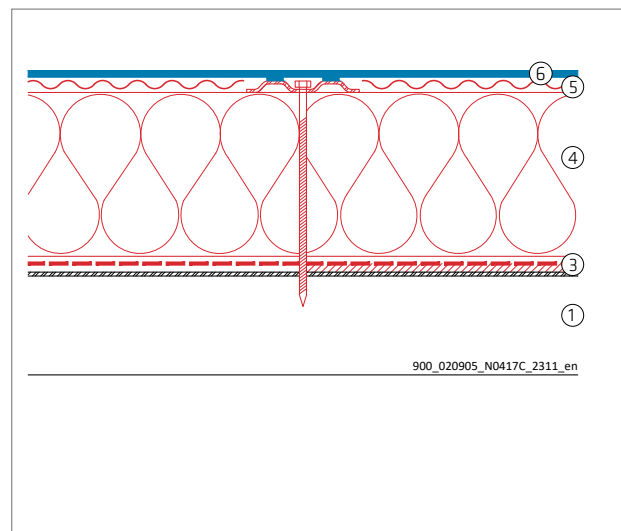

Reinforced concrete

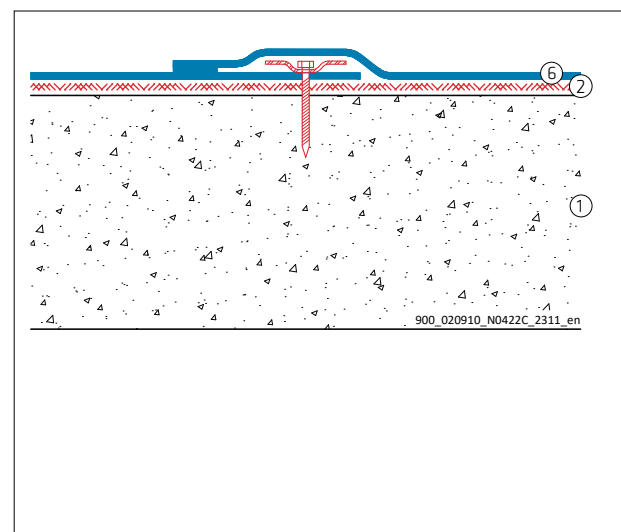
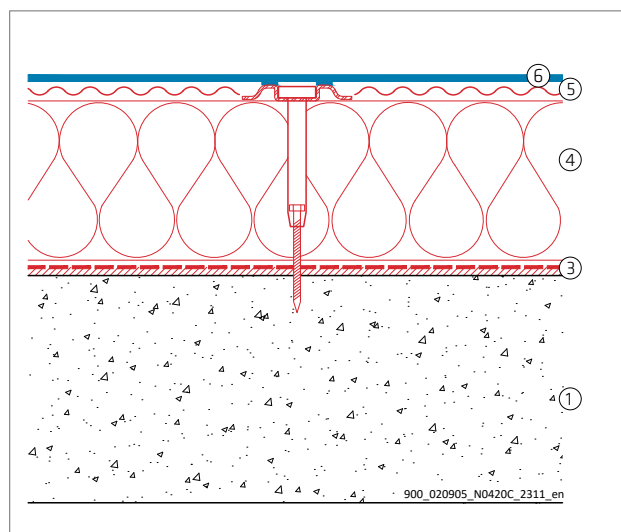

Aerated concrete

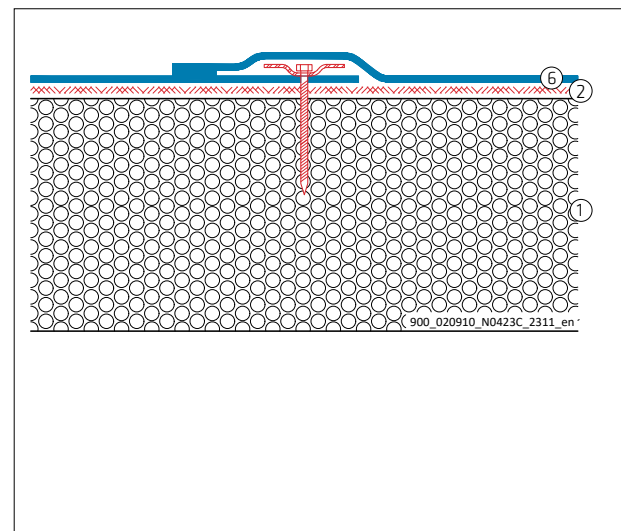
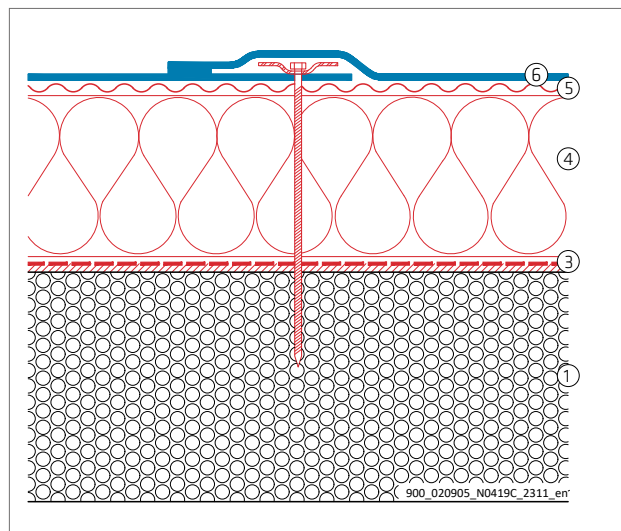

Wood

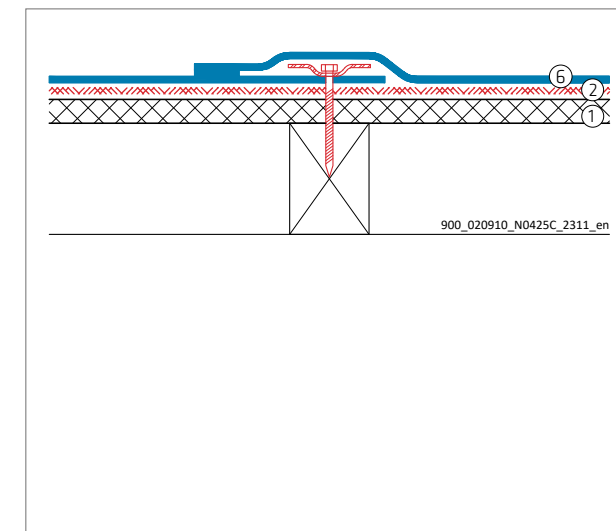
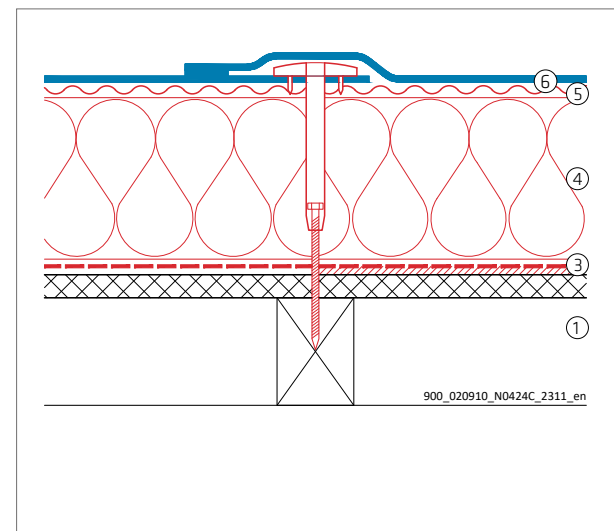

Layer No.	Function	Material	Attachment
1	Roof deck	Steel Reinforced concrete Aerated or lightweight concrete Wood	
2	Levelling- and protection layer (if required)	S-Felt A-300 Sikaplan® W Felt 500 PP S-Felt S-800 S-Felt T-300	Loose laid Loose laid Loose laid Loose laid
3	Vapour- control layer / barrier on steel and wood decks	Sarnavap®-1000 E Sarnavap®-2000 E Sarnavap®-5000 E SA FR Sarnavap®-5000 E SA Sikavap-5000 E SK AL SikaShield® VB E71 PE SA 3 kg/m²	Loose laid Loose laid Self adhered Self adhered Self adhered Self adhered
	Vapour barrier on reinforced and aerated concrete decks	SikaShield® VB E71 PE SA 3 kg/m² SikaShield® VB P41 S 3 mm SikaShield® VB P21 T 3 mm SikaShield® VB P42 S 3 mm	Self adhered Torch applied Torch applied Torch applied
4	Thermal insulation		Mechanically fastened
5	Separation- and fire protection layer (if required)	S-Glass Fleece 120	Loose laid
6	Roof waterproofing membrane	Sarnafil® TS 77	Mechanically fastened

GRAVEL BALLASTED ROOF SYSTEM

**SYSTEM DESCRIPTION**

In gravel ballasted roof systems, the Sarnafil® TG 66 roof waterproofing membrane is covered and ballasted against wind uplift and other exposures with a layer of gravel. Conventional gravel ballasted roofs have been established in most markets for many years and are suitable on most flat roofs and bearing structures.

CHARACTERISTICS / ADVANTAGES

- Fast and easy installation
- No penetration of the roof deck
- Easy to maintain, low maintenance costs
- Protection of the roof waterproofing membrane against environmental exposure and mechanical damage
- The noncombustible properties of the gravel contribute significantly to the fire resistance of the whole roof. The gravel also prevents flames from spreading across the roof surface

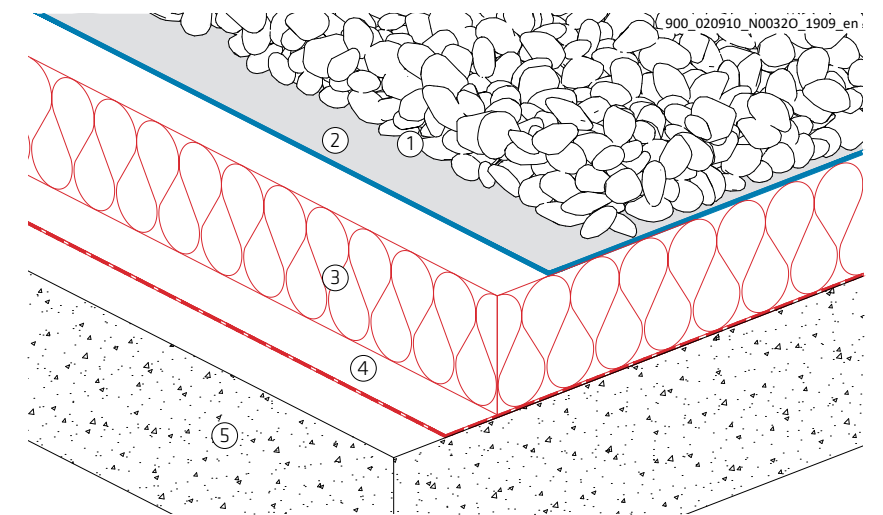

- | | |
|----------------------------|------------------|
| 1 Gravel ballast | 4 Vapour barrier |
| 2 Sarnafil® TG 66 membrane | 5 Roof deck |
| 3 Thermal insulation | |

SYSTEM DESCRIPTION

- The build-up is ballasted with well-rounded and washed gravel 16/32 mm of at least 50 mm and 80 kg/m², securing the roof waterproofing membrane against wind uplift
- If crushed gravel is used, a protection layer is required on top of the roof waterproofing membrane
- Sarnafil® TG 66 roof waterproofing membrane and other roof components, including thermal insulation, are loosely laid

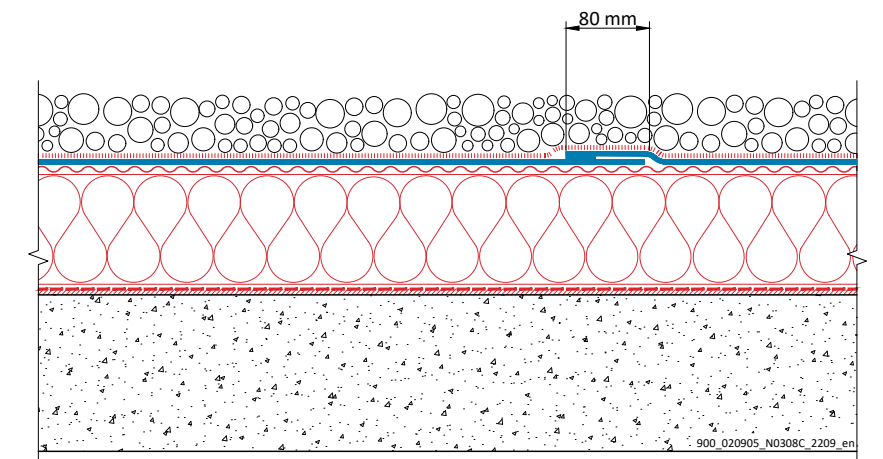

GRAVEL BALLASTED ROOF SYSTEM

Steel

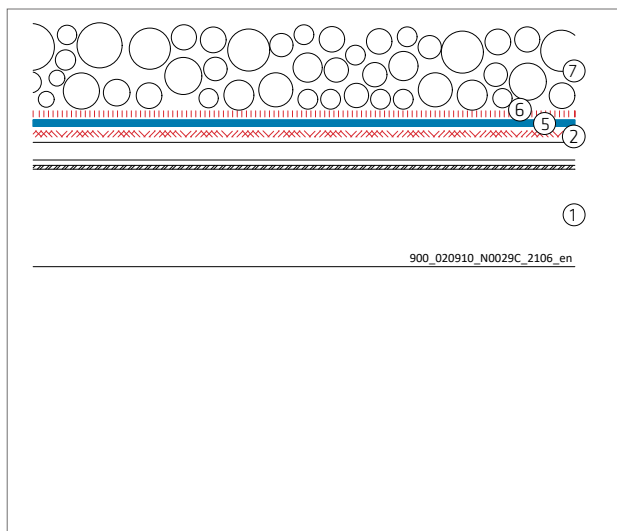
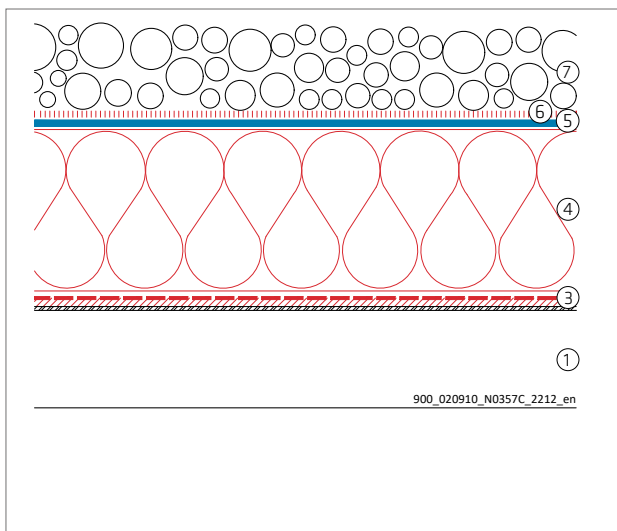

Reinforced concrete

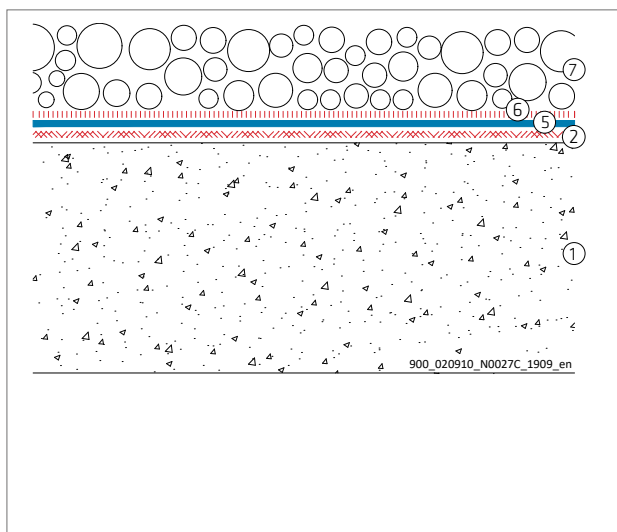
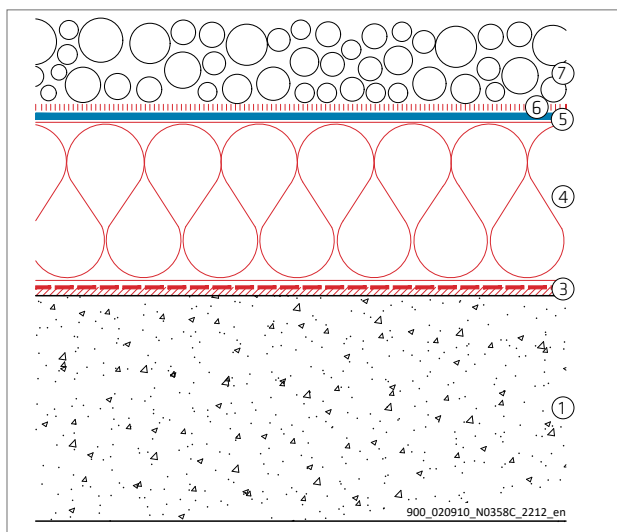

Wood

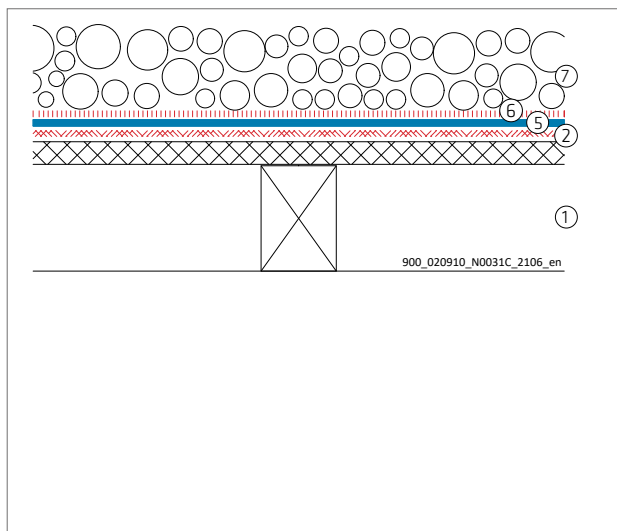
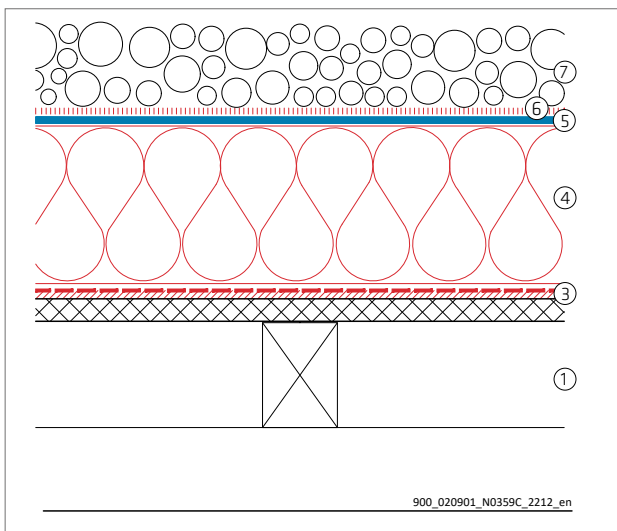

Layer No.	Function	Material	Attachment
1	Roof deck	Steel Reinforced concrete Wood	
2	Levelling- and protection layer (if required)	S-Felt A-300 Sikaplan® W Felt 500 PP S-Felt S-800 S-Felt T-300	Loose laid Loose laid Loose laid Loose laid
3	Vapour barrier on steel and wood decks	Sarnavap®-5000 E SA FR Sarnavap®-5000 E SA Sikavap-5000 E SK AL SikaShield® VB E71 PE SA 3 kg/m ²	Self adhered Self adhered Self adhered Self adhered
	Vapour barrier on reinforced concrete decks	SikaShield® VB E71 PE SA 3 kg/m ² SikaShield® VB P41 S 3 mm SikaShield® VB P21 T 3 mm SikaShield® VB P42 S 3 mm	Self adhered Torch applied Torch applied Torch applied
4	Thermal insulation		Loose laid
5	Roof waterproofing membrane	Sarnafil® TG 66	Loose laid
6	Protection layer (if required)	S-Felt A-300 Sikaplan® W Felt 500 PP S-Felt S-800 S-Felt T-300	Loose laid Loose laid Loose laid Loose laid
7	Ballast	Gravel	Loose laid

INVERTED ROOF SYSTEM

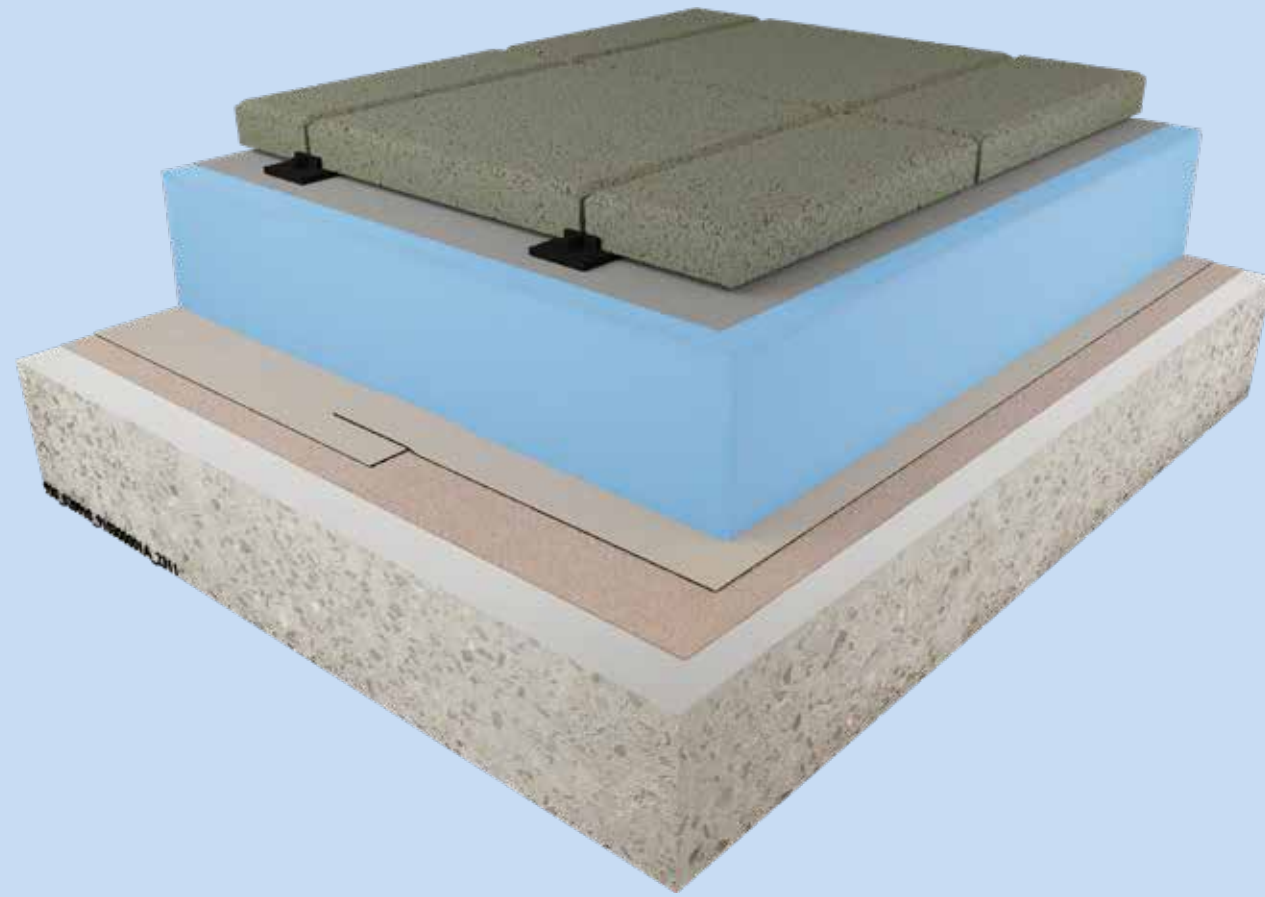

SYSTEM DESCRIPTION

In this type of construction the principal thermal insulation material is applied on top of the Sarnafil® TG 66 roof waterproofing membrane so that the complete roof construction including roof covering is kept at warm temperatures during the winter months and at moderate temperatures during the summer months; the system is also referred to as a “protected membrane”, or “upside down” roof.

CHARACTERISTICS / ADVANTAGES

- Fast and easy installation
- No penetration of the roof deck
- Additional protection of the roof waterproofing membrane
- High fire resistance

SYSTEM DESCRIPTION

- The build-up is ballasted with gravel, pavings or green roof securing the thermal insulation against wind uplift
- The filter layer prevents small particles from penetrating gaps and voids into thermal insulation
- Sarnafil® TG 66 roof waterproofing membrane and other roof components, including thermal insulation, are loosely laid

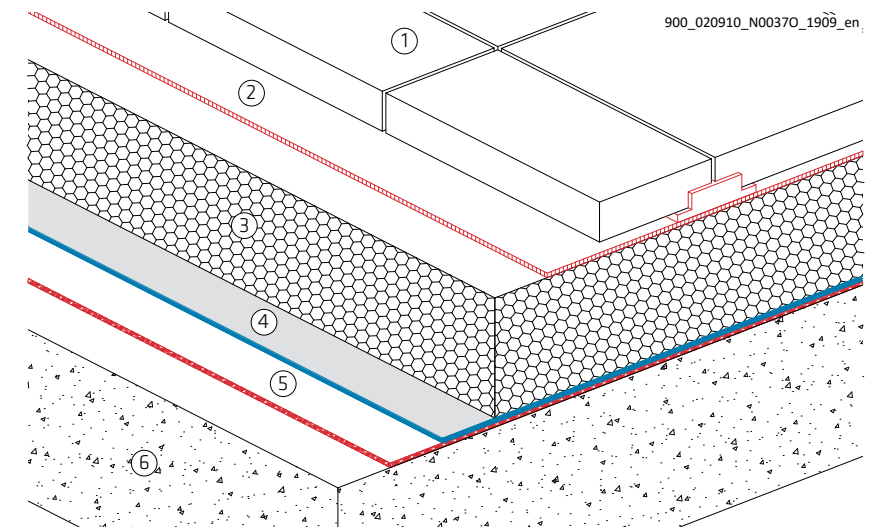

- | | |
|--------------------------|-----------------------------------|
| 1 Ballast | 4 Sarnafil® TG 66 membrane |
| 2 Filter layer | 5 Levelling- and protection layer |
| 3 Thermal insulation XPS | 6 Roof deck |

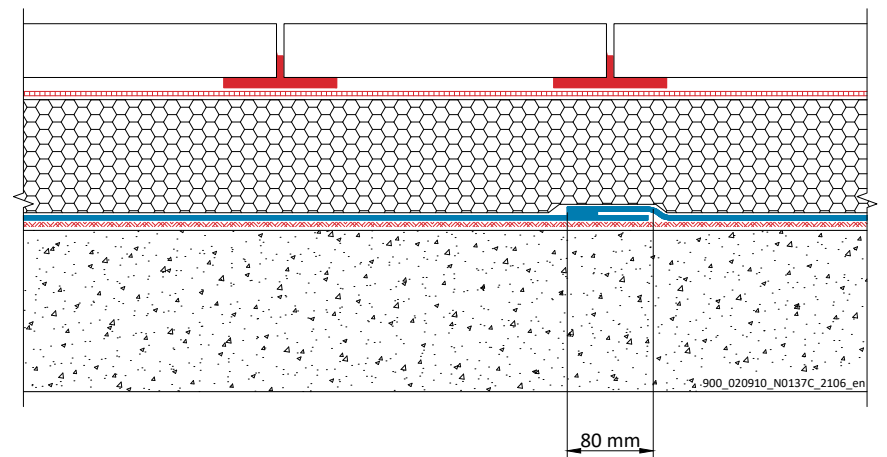

INVERTED ROOF SYSTEM

Reinforced concrete

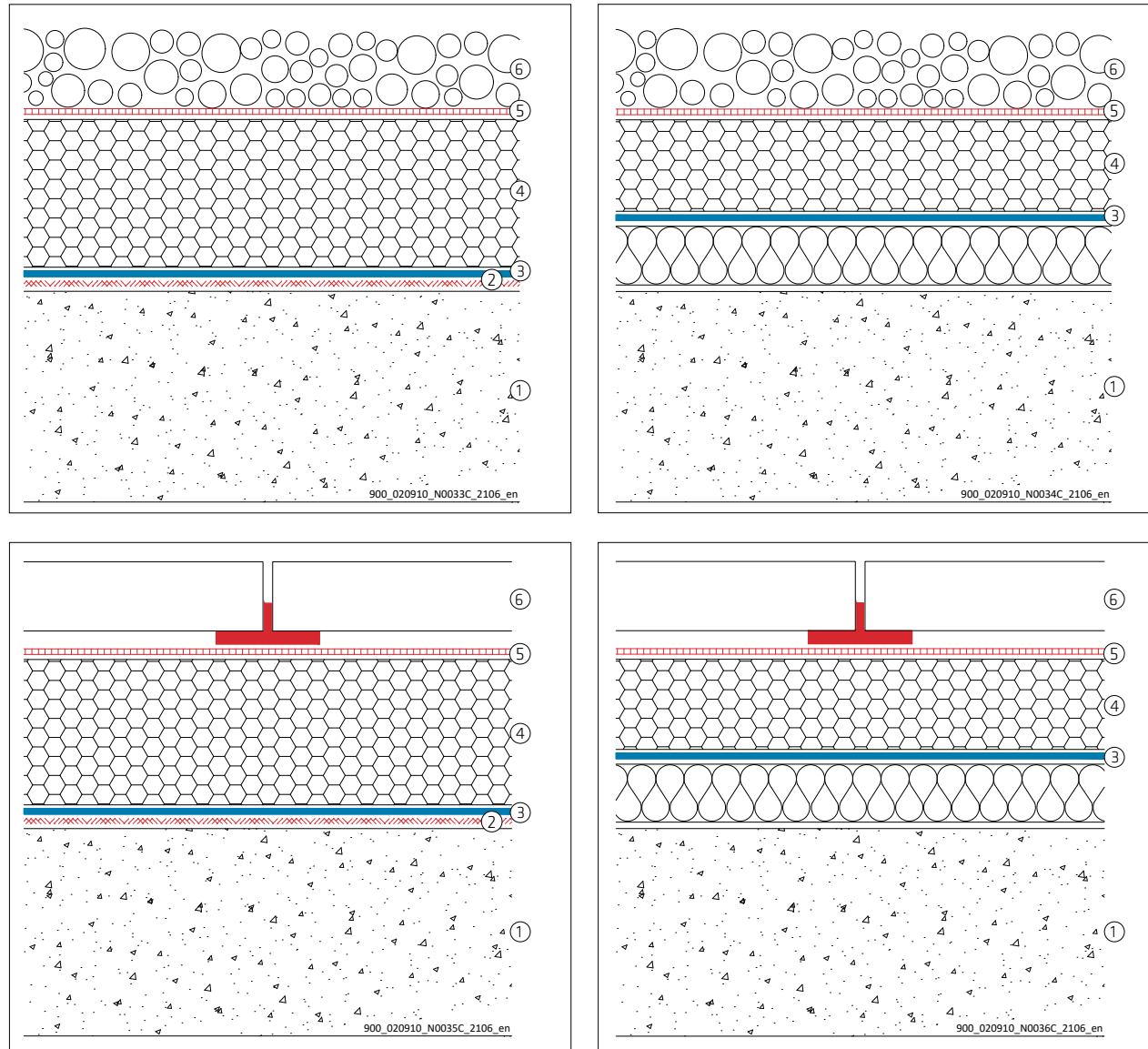

Layer No.	Function	Material	Attachment
1	Roof deck	Reinforced concrete	
2	Levelling- and protection layer (if required)	S-Felt A-300 Sikaplan® W Felt 500 PP S-Felt S-800 S-Felt T-300	Loose laid Loose laid Loose laid Loose laid
3	Roof waterproofing membrane	Sarnafil® TG 66	Loose laid
4	Thermal insulation	XPS	Loose laid
5	Filter layer	S-Felt VS-140	Loose laid
6	Ballast	Gravel Paving slabs	Loose laid Loose laid

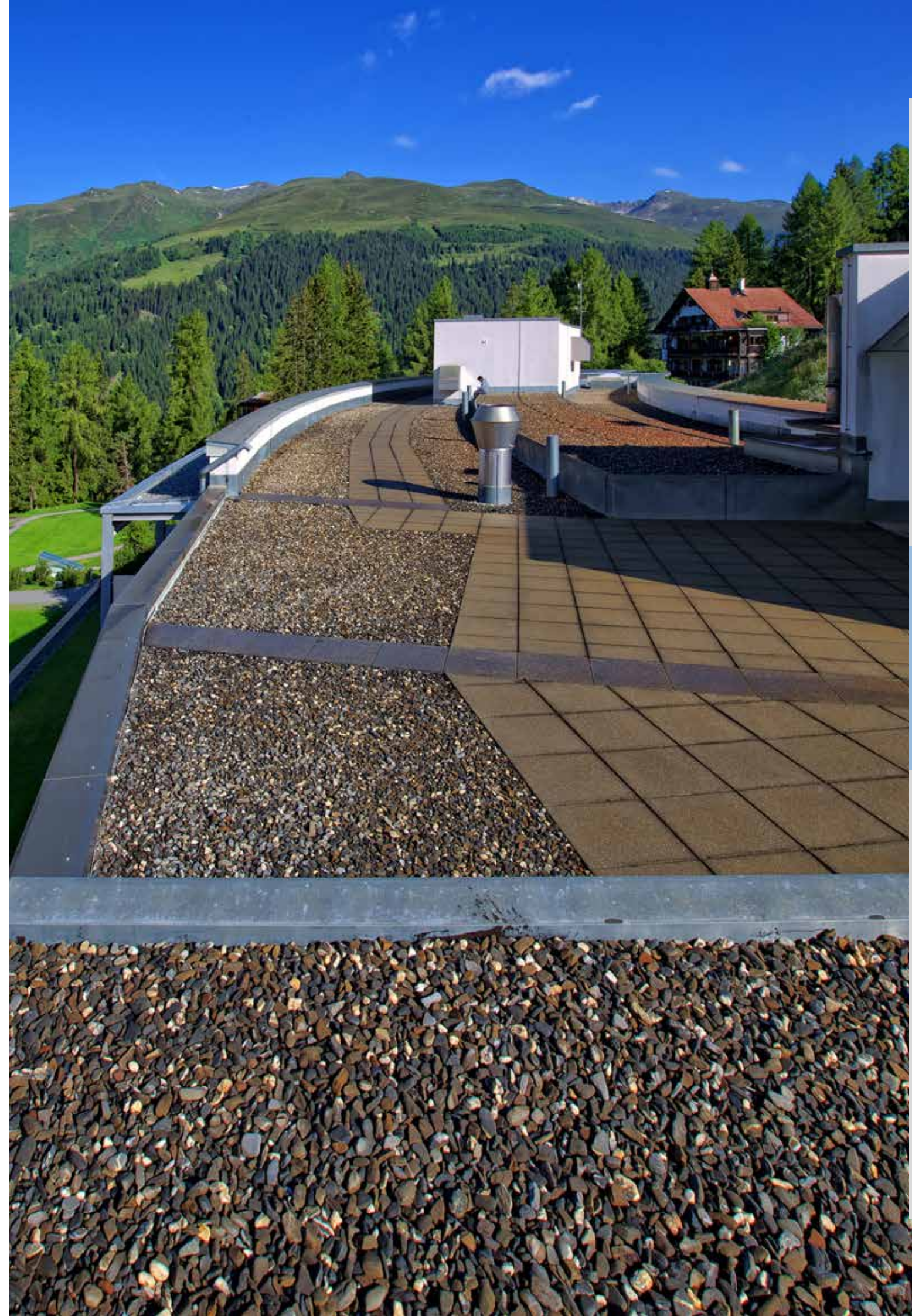

UTILITY ROOF SYSTEM

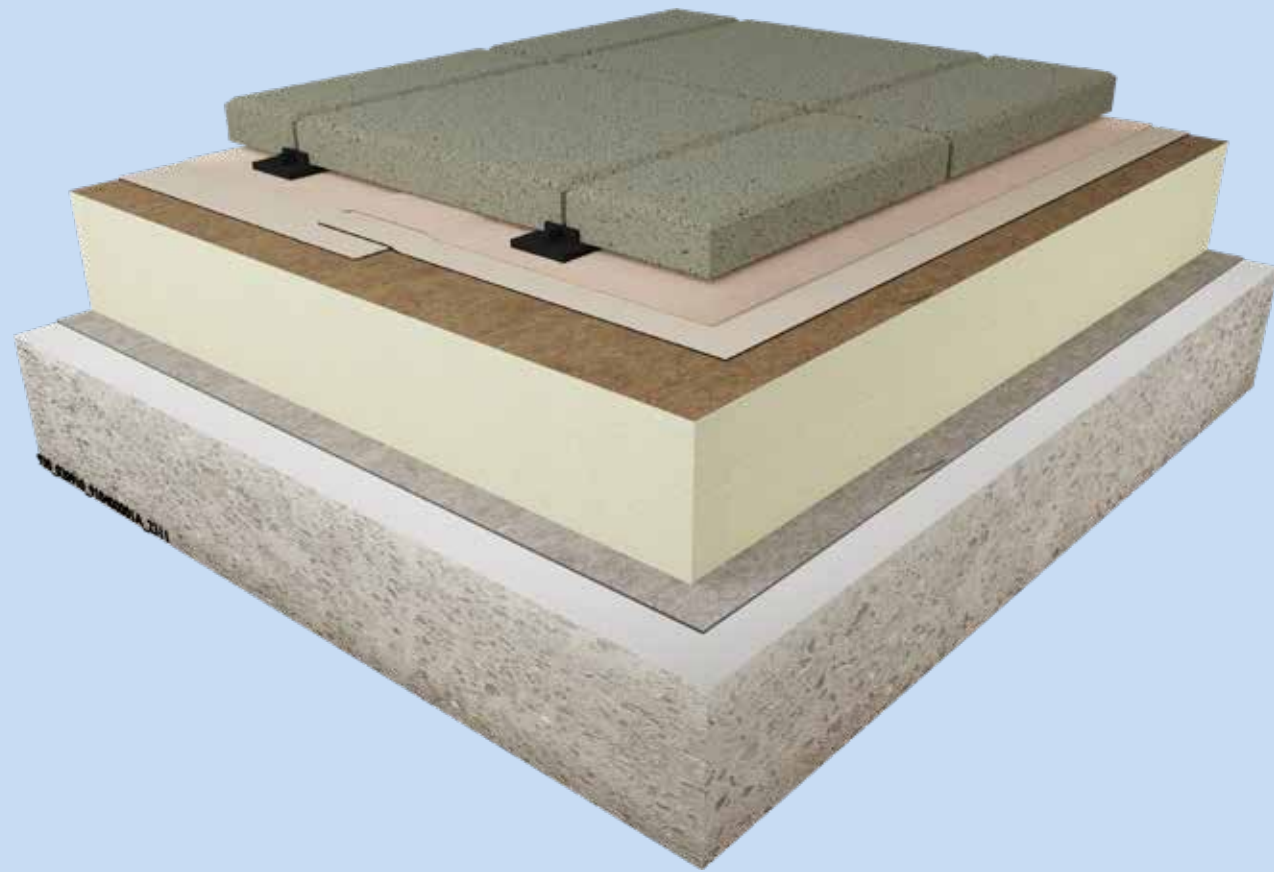

SYSTEM DESCRIPTION

Create more utilized space and bring additional value to the building. Further on that they generate an increased return on investment by using the roof for a car park, restaurant area or any other viable purpose or facility.

CHARACTERISTICS / ADVANTAGES

- The roof waterproofing membrane is protected against any aggressive environmental exposure and mechanical damage
- The natural non-combustible properties of the paved wearing surface contribute significantly to the fire resistance of the whole roof

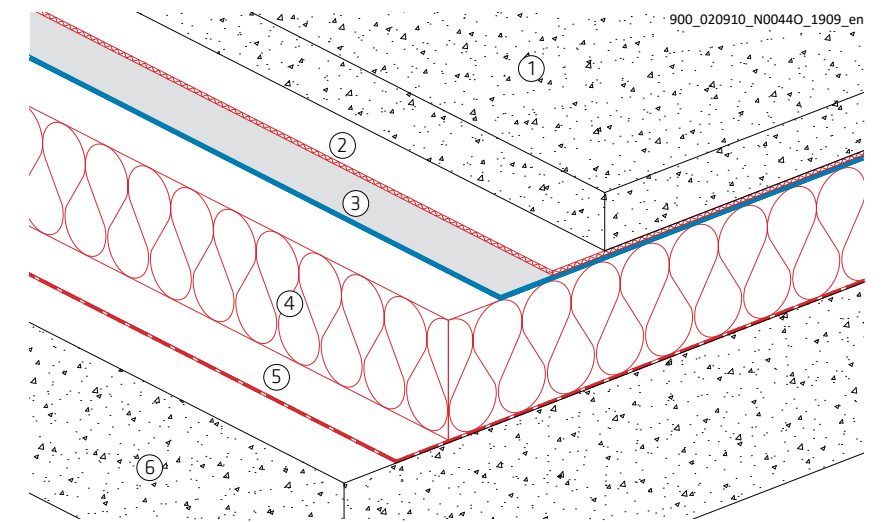

- | | |
|------------------------------|----------------------|
| 1 Paving slabs / concrete | 4 Thermal insulation |
| 2 Protection- and slip layer | 5 Vapour barrier |
| 3 Sarnafil® TG 66 membrane | 6 Roof deck |

SYSTEM DESCRIPTION

- The build-up is ballasted with pavings or concrete slab securing the thermal insulation against wind uplift
- Slip- and protection layer to be laid above roof waterproofing membrane in case of concrete slab on top
- Sarnafil® TG 66 roof waterproofing membrane and other roof components, including thermal insulation, are loosely laid

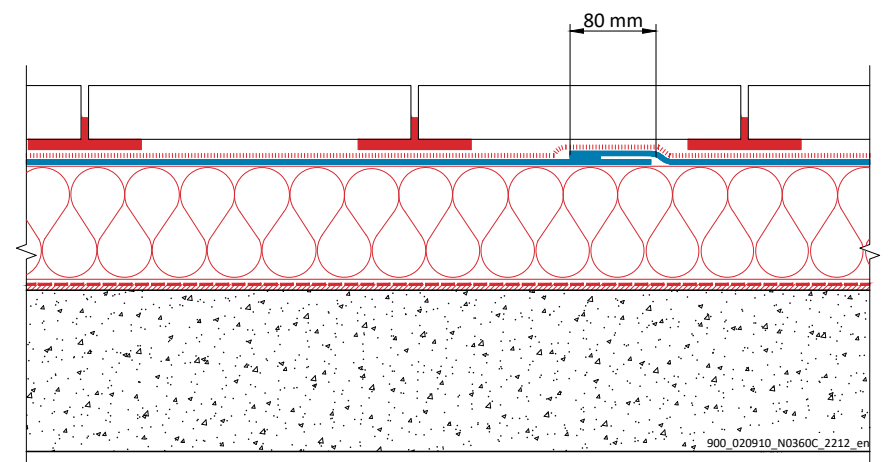

UTILITY ROOF SYSTEM

Reinforced concrete

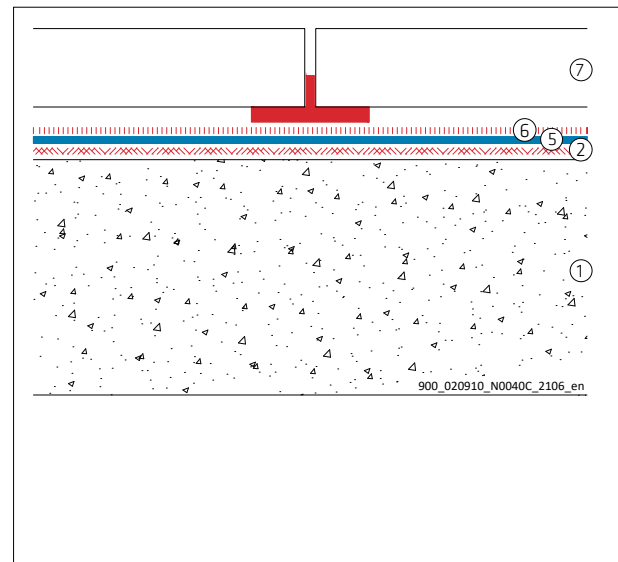
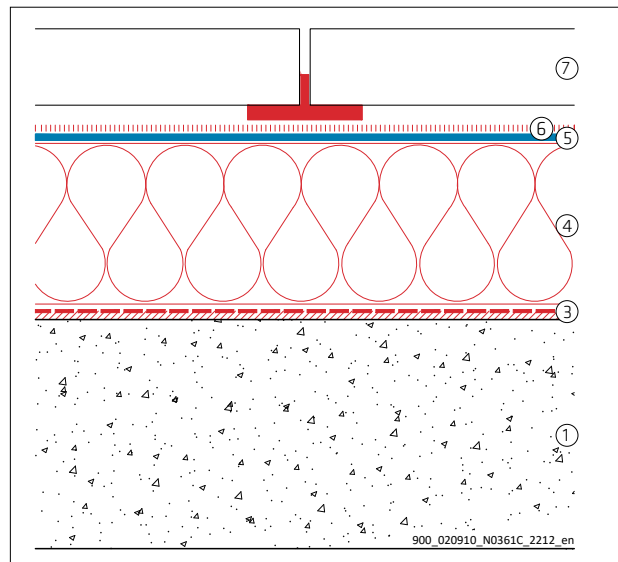
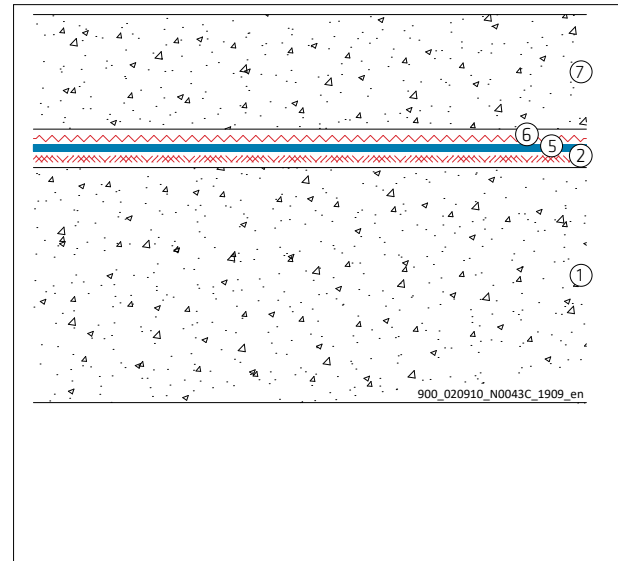
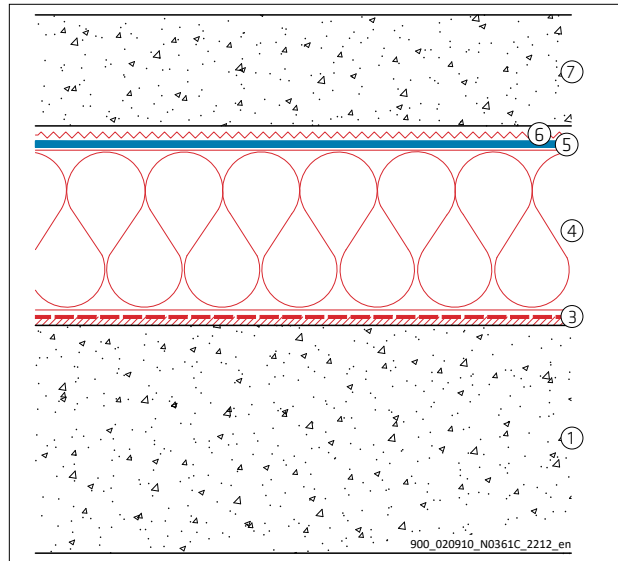

Layer No.	Function	Material	Attachment
1	Roof deck	Reinforced concrete	
2	Levelling- and protection layer (if required)	S-Felt A-300 Sikaplan® W Felt 500 PP S-Felt S-800 S-Felt T-300	Loose laid Loose laid Loose laid Loose laid
3	Vapour barrier	SikaShield® VB E71 PE SA 3 kg/m ² SikaShield® VB P41 S 3 mm SikaShield® VB P21 T 3 mm SikaShield® VB P42 S 3 mm	Self adhered Torch applied Torch applied Torch applied
4	Thermal insulation		Loose laid
5	Roof waterproofing membrane	Sarnafil® TG 66	Loose laid
6	Protection- and slip layer in case of concrete deck above	S-Felt GK-400	Loose laid
	Protection layer (if required) in case of paving slabs above	S-Felt A-300 Sikaplan® W Felt 500 PP S-Felt S-800 S-Felt T-300	Loose laid Loose laid Loose laid Loose laid
7	Ballast	Concrete Paving slabs	Loose laid

GREEN ROOF SYSTEM



SYSTEM DESCRIPTION

In so called "Green Roofs" soil, or a suitable plant growing medium, is built-up and planted with selected vegetation over the roof waterproofing membrane. Green roofs can therefore make a significant contribution and present practical solutions in the quest for sustainability, increased biodiversity and quality of life.

CHARACTERISTICS / ADVANTAGES

- Reducing heat - island effect in cities
- Enhancing the aesthetics of the building
- Improved thermal performance of the building
- A natural environment on the roof with natural CO₂ absorption

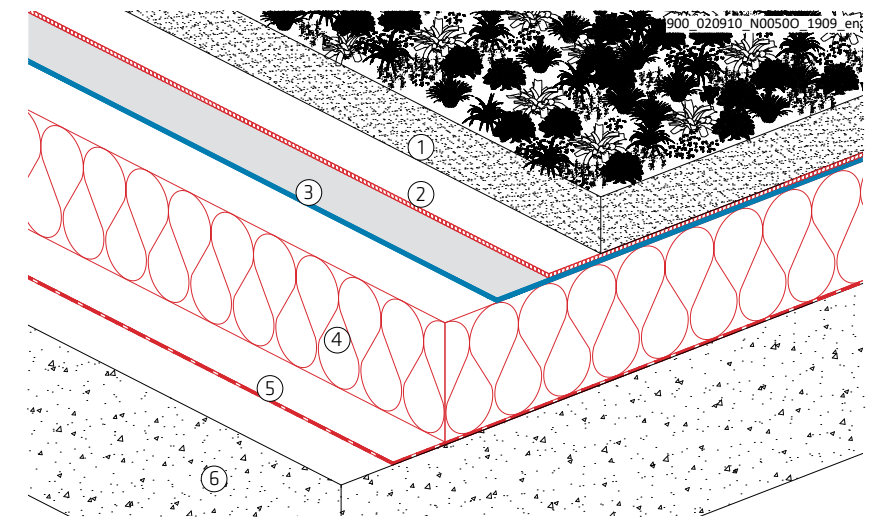

- | | |
|---|----------------------|
| 1 Green roof | 4 Thermal insulation |
| 2 Drainage-, filter- and protection layer | 5 Vapour barrier |
| 3 Sarnafil® TG 66 membrane | 6 Roof deck |

SYSTEM DESCRIPTION

Green roof systems are classified as:

Extensive

Have a shallow growing medium with small plants and require low maintenance. Soil with plants 50 - 150 mm thick and 50 - 170 kg/m². Minimum slope of 1.50%.

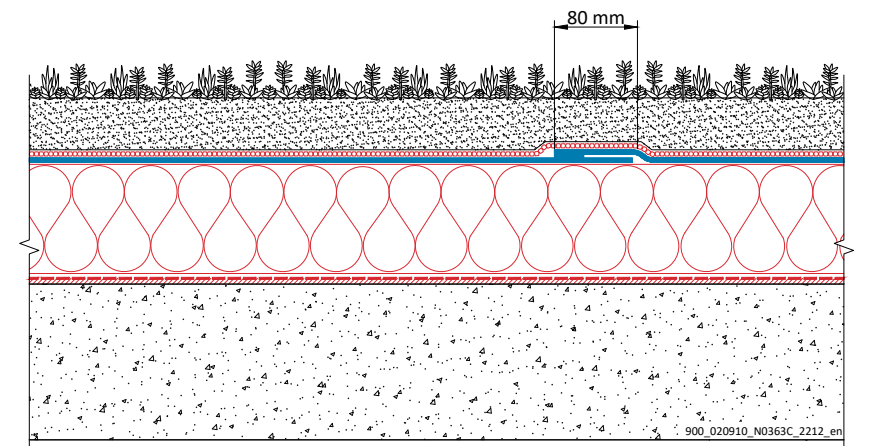

Intensive

Have a thicker soil layer with additional drainage for planting larger plants, bushes and small trees, thus creating roof gardens. Soil with plants minimum 150 mm thick and 170 kg/m. Suitable for roof systems without slope.

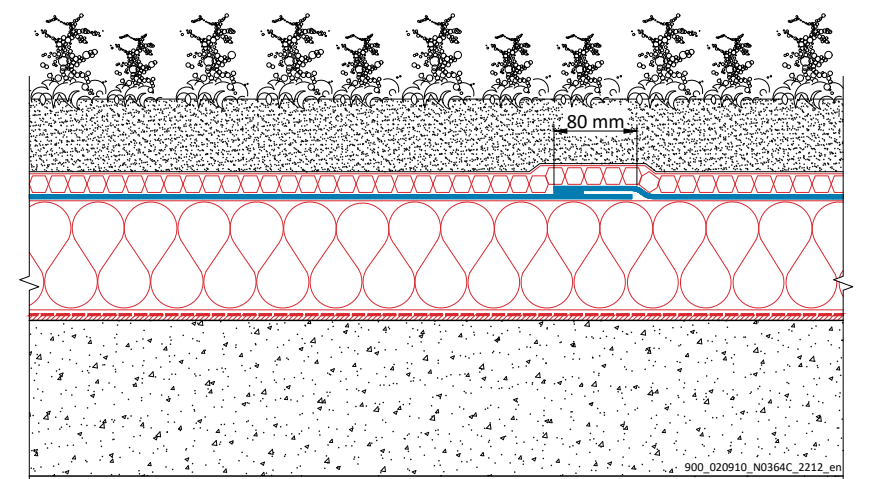

GREEN ROOF SYSTEM

Reinforced concrete

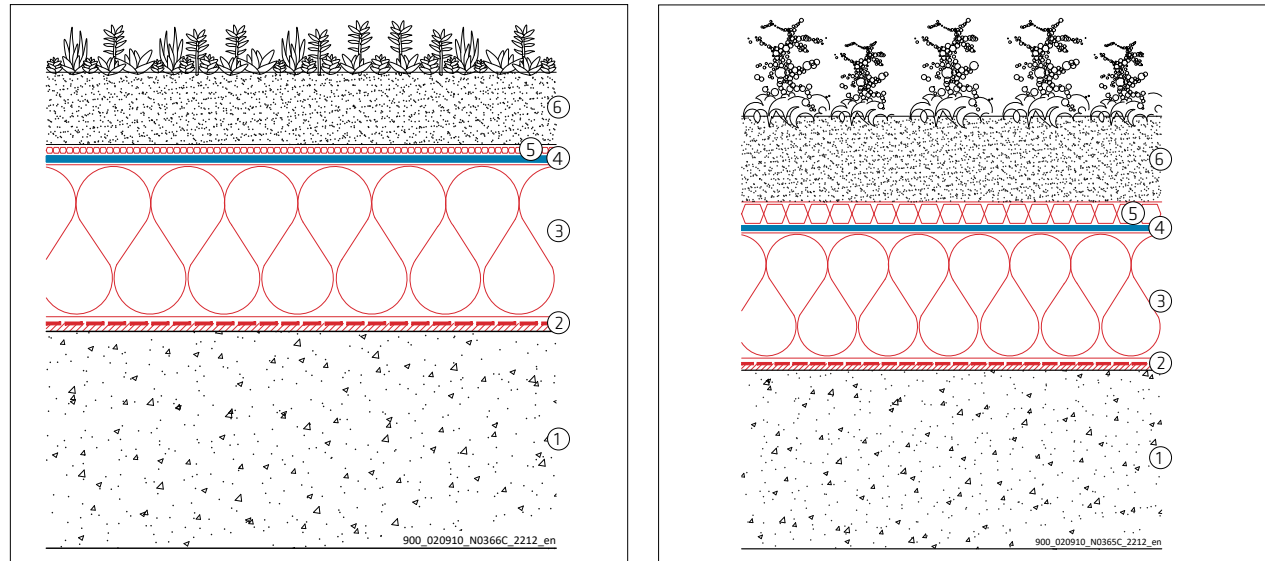

Layer No.	Function	Material	Attachment
1	Roof deck	Reinforced concrete	
2	Vapour barrier	SikaShield® VB E71 PE SA 3 kg/m ² SikaShield® VB P41 S 3 mm SikaShield® VB P21 T 3 mm SikaShield® VB P42 S 3 mm	Self adhered Torch applied Torch applied Torch applied
3	Thermal insulation		Loose laid
4	Roof waterproofing membrane	Sarnafil® TG 66	Loose laid
5	Protection-, drainage- and filter layer Extensive green roof system	Aquadrain 550	Loose laid
	Protection-, drainage- and filter layer Intensive green roof system	SikaRoof® Drainage Layer 20L2F	Loose laid
6	Ballast	Extensive or intensive	Loose laid



ADHERED ROOF SYSTEM

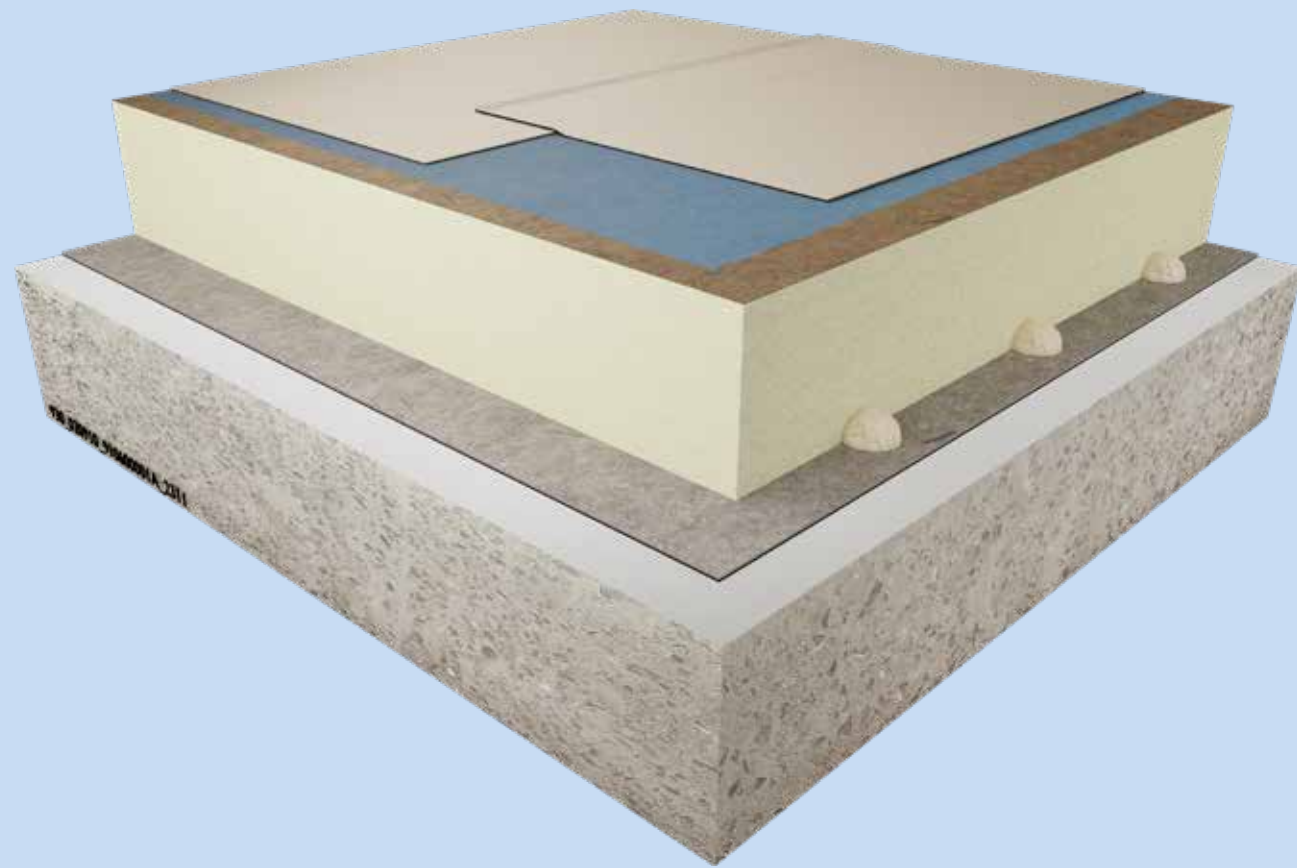

SYSTEM DESCRIPTION

This system is designed to fulfil the highest aesthetic requirements! The membranes can be adhered to flat, curved or sloped roof of practically any shape and configuration.

CHARACTERISTICS / ADVANTAGES

- No penetrations of the roof deck are required
- Very low noise emissions during installation
- Easy refurbishment of existing bitumen roofs

SYSTEM DESCRIPTION

Build-up fully adhered

Roof waterproofing membrane adhered with adhesive or self adhered membrane to the substrate underneath. All other layers to be adhered to each other.

Build-up adhered roof waterproofing membrane combined with mechanically fastened system

Vapour control layer loose laid or vapour barrier self adhered or hot applied and mechanically fastened of thermal insulation onto roof deck.

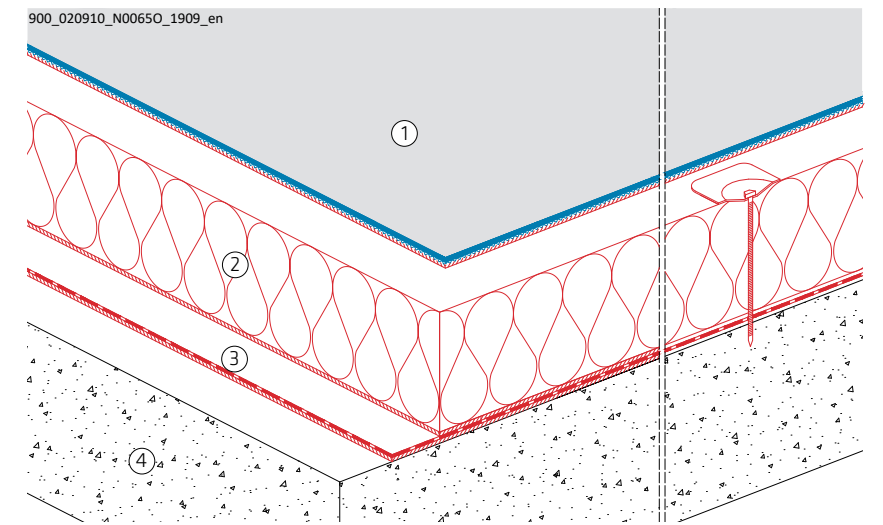

- 1 Sarnafil® TG 76 membrane, adhered
- 2 Thermal insulation, adhered or mechanically fastened
- 3 Vapour barrier (fully adhered system) or vapour control layer (adhered roof waterproofing membrane combined with mechanically fastened system)
- 4 Roof deck

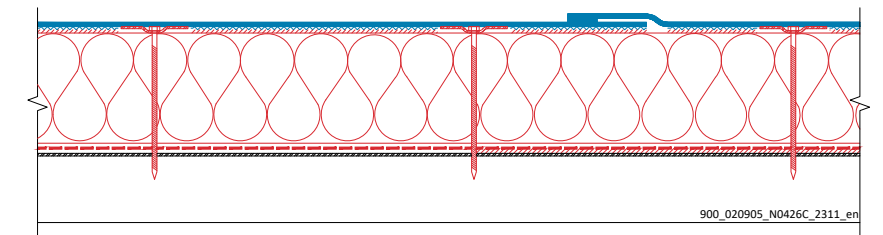
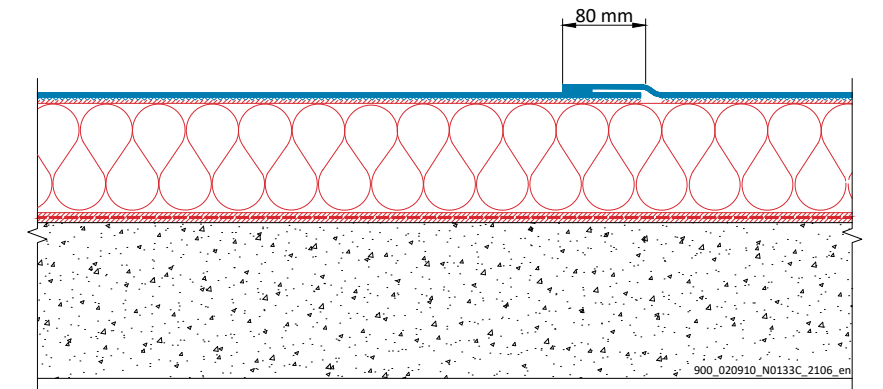

ADHERED ROOF SYSTEM

Steel

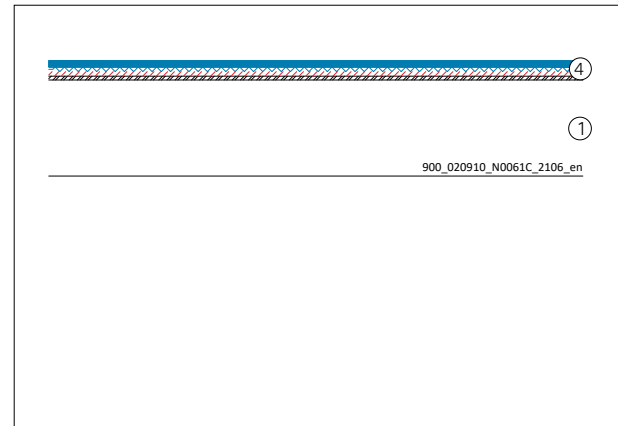
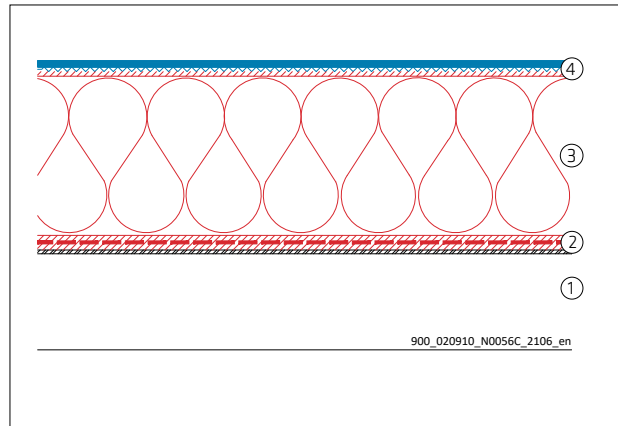

Reinforced concrete

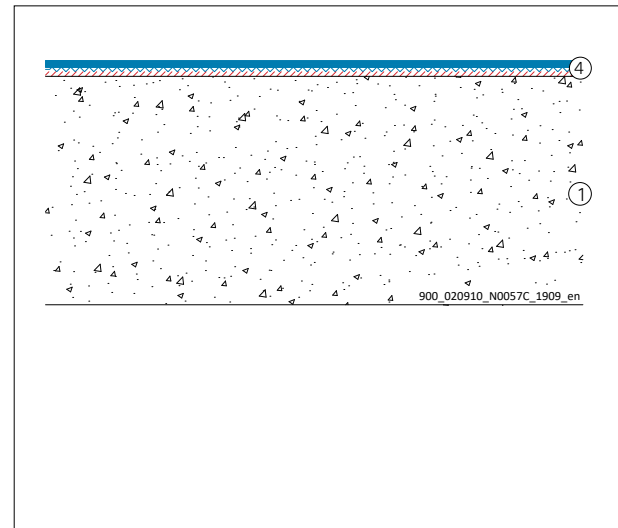
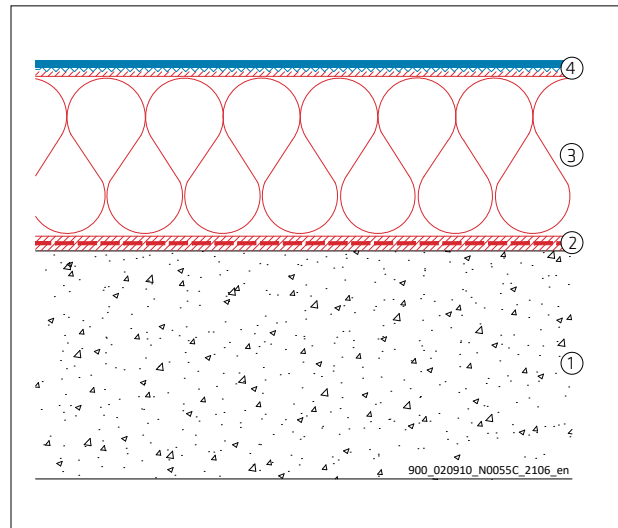

Adhered concrete

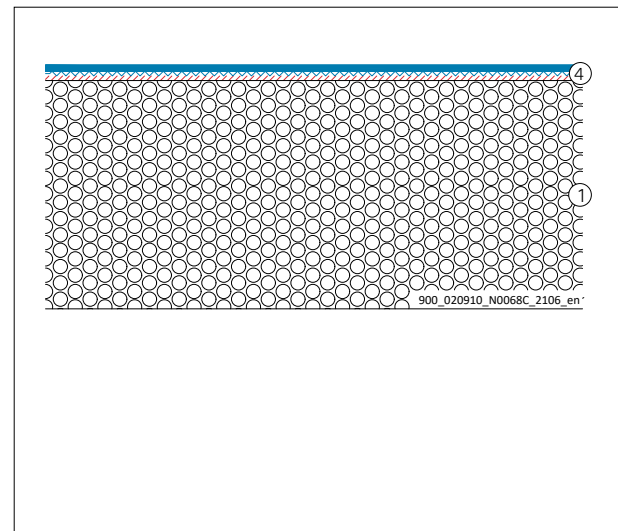
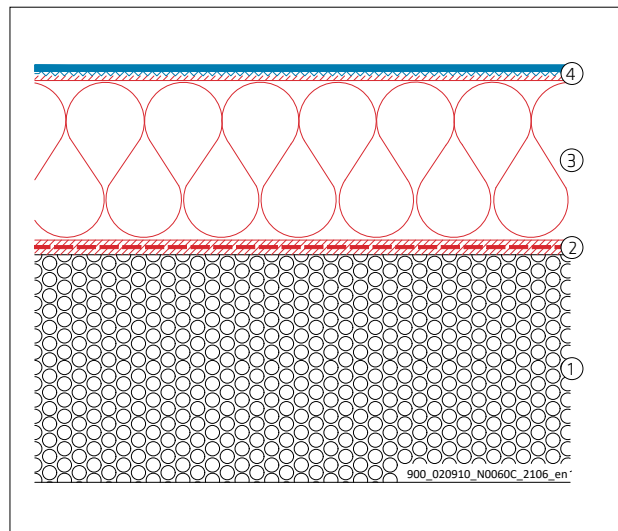

Wood

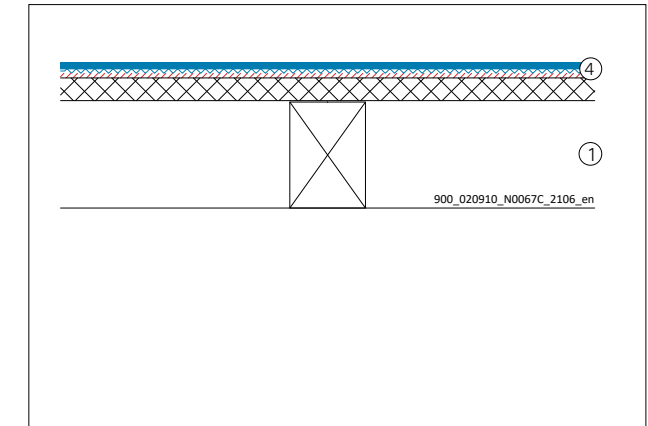
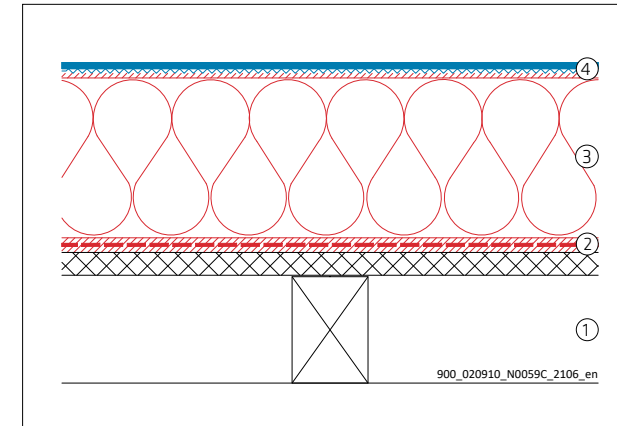

Steel

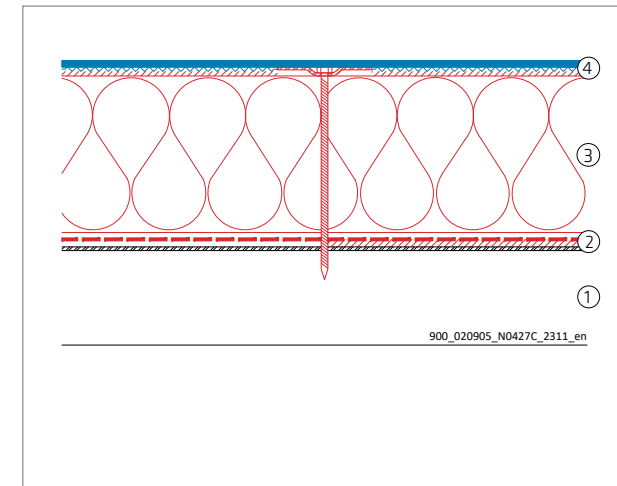

Reinforced concrete

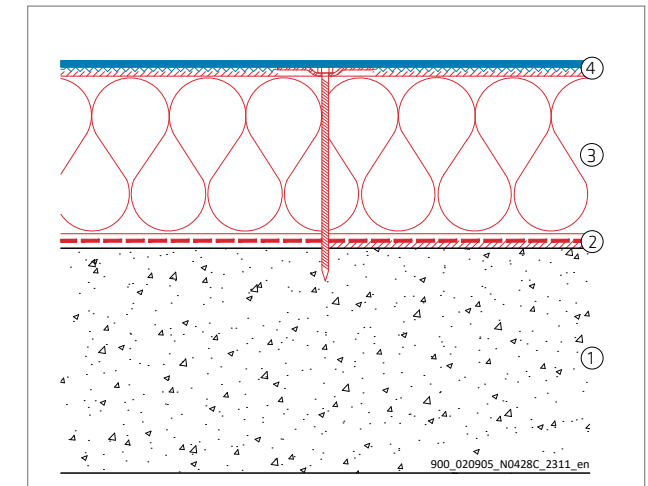

Layer No.	Function	Material	Attachment
1	Roof deck	Steel Reinforced concrete Aerated or lightweight concrete Wood Metal Composite Panel	
2	Vapour- control layer / barrier on steel and wood decks	Sarnavap®-1000 E* Sarnavap®-2000 E* Sarnavap®-5000 E SA FR* Sarnavap®-5000 E SA Sikavap-5000 E SK AL* SikaShield® VB E71 PE SA 3 kg/m ² *	Loose laid Loose laid Self adhered Self adhered Self adhered Self adhered
	Vapour barrier on reinforced, aerated or lightweight concrete decks	SikaShield® VB E71 PE SA 3 kg/m ² * SikaShield® VB P41 S 3 mm SikaShield® VB P21 T 3 mm SikaShield® VB P42 S 3 mm*	Self adhered Torch applied Torch applied Torch applied
3	Thermal insulation		Adhered Mechanically fastened
4	Roof waterproofing membrane	Sarnafil® TG 76 Felt PS Sarnafil® TG 76 E Felt PS Sarnafil® TG 76 FSA	Adhered Adhered Self adhered

* Not approved for fully bonded systems

ADHERED ROOF SYSTEM

		Sarnacol®-2142 S	Sarnacol®-2142 V	Sarnacol® T-660	Sarnafil® TG 76 Felt PS	Sarnafil® TG 76 E Felt PS	Sarnafil® TG 76 FSA	SikaRoof® Board Adhesive
Membranes	Sarnafil® TG 66			●				
	Sarnafil® TG 76 Felt PS / Sarnafil® TG 76 E Felt PS	●	●					
Application	Fully Adhered	●	●	●	●	●		
	Self adhered						●	
	Insulation Adhesive							●
Area	Flat				●	●	●	●
	Sloped	● ¹⁾	● ¹⁾			●	●	●
	Detailing / Upstands			●				
Substrates	Concrete	●	●	●	●	●	● ¹⁾	●
	Metal / Steel	●	●	●	●	●	● ¹⁾	●
	Wood (e.g. OSB, Plywood)	●	●	●	●	●	● ^{1)/2)}	●
	Metal Composite Panel ³⁾	●	●		●	●	●	●
	Bitumen – slated or sanded	●	●	●	●	●	● ¹⁾	●
	Polyester, hard and soft PVC			●				
	EPS / XPS	●	●		●	●	●	●
	Coverboards	●	●	●	●	●	●	●
	Mineralwool	●	●	●	●	●	● ^{1)/2)}	●
	PIR – with glass tissue facer	●	●	●	●	●	● ^{1)/2)}	●
PIR – with aluminium composite facer	●	●	●	●	●	●	●	
VOC Free			●				●	

● Approved

¹⁾ Slope > 10°, additional mechanical securement is required till adhesive has set

¹⁾ Primer-600

²⁾ Primer-780

³⁾ Product specific approval on request

ROOF REFURBISHMENT



SYSTEM DESCRIPTION

Roofs have limited lifespan. Old or inadequate roofs should be refurbished before the building suffers deterioration or damage.

Sika Roofing Systems are ideally suited for refurbishment work.

Your local sales organisation can provide all the necessary technical support.

APPLICATION INSTRUCTIONS

ROOF REFURBISHMENT

Refurbishment of existing roof constructions becoming more and more common and Sika has various systems for all kind of substrates.

- Bitumen Roofs
- Metal Roofs
- Singly-ply Synthetic Roofs EPDM, PVC, FPO

For the selection of the right refurbishment system, a specific project survey and assessment has to be undertaken. Please contact the Technical Services Department of your local Sika company for assistance. All roof build-up's shall be reviewed by a building physics specialist / engineer.

OVERLAYING OR REPLACING EXISTING SYNTHETIC OR BITUMINOUS ROOFING WITHOUT THERMAL INSULATION UPGRADE

MECHANICALLY FASTENED ROOF SYSTEM

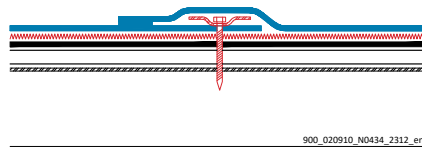

- Sarnafil® TS 77 membrane, mechanically fastened
- S-Felt T-300, separation layer
- Existing synthetic or bituminous roofing

GRAVEL BALLASTED ROOF SYSTEM

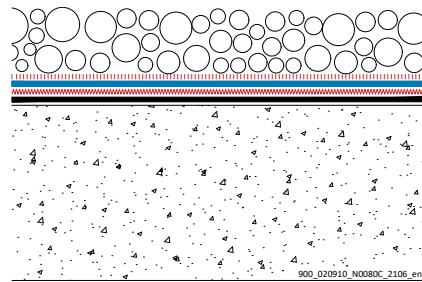

- Gravel ballast
- S-Felt A-300 or Sikaplan® W Felt 500 PP or S-Felt S-800 or S-Felt T-300, protection layer (if required)
- Sarnafil® TG 66 membrane, loose laid
- S-Felt T-300, separation layer
- Existing synthetic or bituminous roofing

UTILITY ROOF SYSTEM

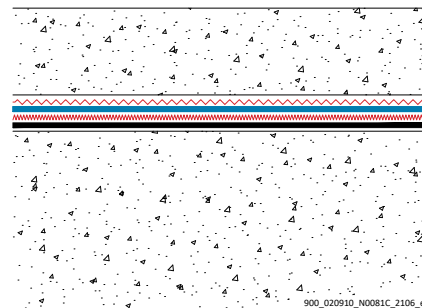

- Concrete slab
- S-Felt GK-400, slip- and protection layer
- Sarnafil® TG 66 membrane, loose laid
- S-Felt T-300 separation layer
- Existing synthetic or bituminous roofing

GREEN ROOF SYSTEM

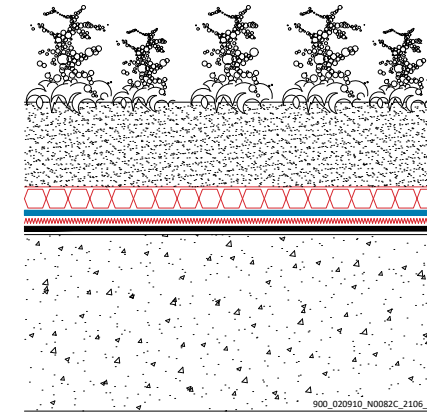

- Green roof (extensive or intensive)
- Aquadrain-550 (extensive) or SikaRoof® Drainage Layer 20L2F (intensive), drainage, filter- and protection layer
- Sarnafil® TG 66 membrane, loose laid
- S-Felt T-300, separation layer
- Existing synthetic or bituminous roofing

ADHERED ROOF SYSTEM

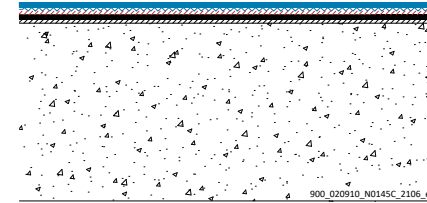

- System A**
 - Sarnafil® TG 76 FSA, self-adhered
 - Primer 600, primer
 - Bituminous roofing
- System B**
 - Sarnafil® TG 76 Felt PS or Sarnafil® TG 76 E Felt PS, adhered
 - Sarnacol®-2142, adhesive
 - Bituminous roofing

Above synthetic roofing membrane specific project approval by Sika Technical Department needed.

Note: In general, it is recommended to remove the existing synthetic or bituminous roofing before installing a new membrane.

ROOF REFURBISHMENT

OVERLAYING OR REPLACING EXISTING SYNTHETIC OR BITUMINOUS ROOFING WITH THERMAL INSULATION UPGRADE

MECHANICALLY FASTENED ROOF SYSTEM

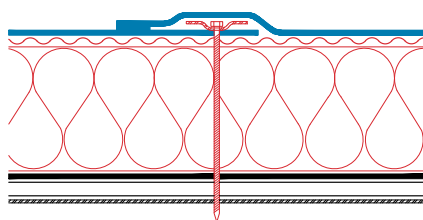

900_020910_N0429C_2311_en

- Sarnafil® TS 77 membrane, mechanically fastened
- S-Glass Fleece-120, separation- and fire protection layer (if required)
- New thermal Insulation, mechanically fastened
- Existing synthetic or bituminous roofing

GRAVEL BALLASTED ROOF SYSTEM

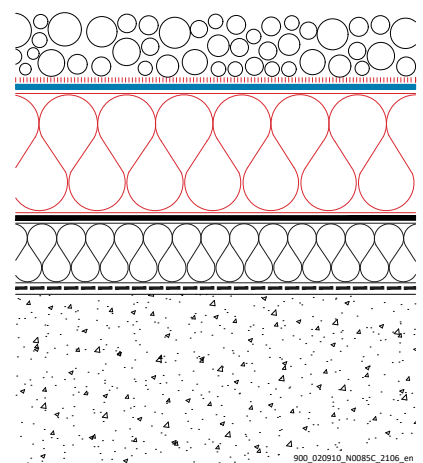

900_020910_N0085C_2106_en

- Gravel ballast
- S-Felt A-300 or Sikaplan® W Felt 500 PP or S-Felt S-800 or S-Felt T-300, protection layer (if required)
- Sarnafil® TG 66 membrane, loose laid
- New / additional thermal Insulation, loose laid
- Existing synthetic or bituminous roofing

UTILITY ROOF SYSTEM

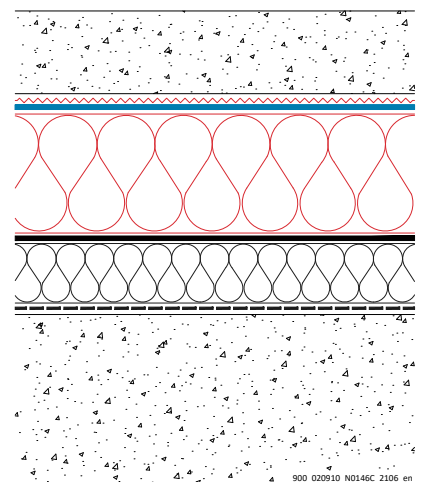

900_020910_N0146C_2106_en

- Concrete Slab
- S-Felt GK-400, slip- and protection layer
- Sarnafil® TG 66 membrane, loose laid
- New / additional thermal Insulation, loose laid
- Existing synthetic or bituminous roofing

GREEN ROOF SYSTEM

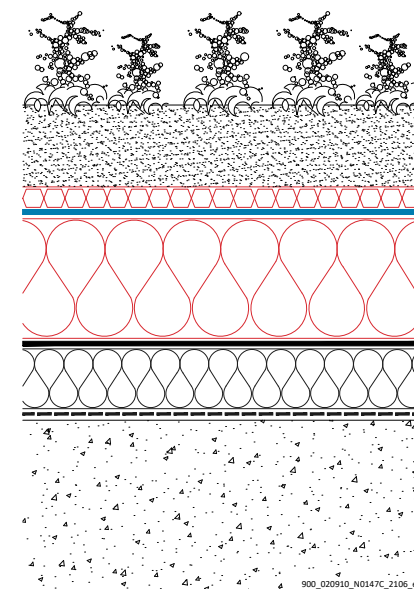

900_020910_N0147C_2106_en

- Green Roof (extensive or intensive)
- Aquadrain-550 (extensive) or SikaRoof® Drainage Layer 20L2F (intensive), drainage, filter- and protection layer
- Sarnafil® TG 66 membrane, loose laid
- New / additional thermal Insulation, loose laid
- Existing synthetic or bituminous roofing

ADHERED ROOF SYSTEM - EXISTING BITUMINOUS ROOFING

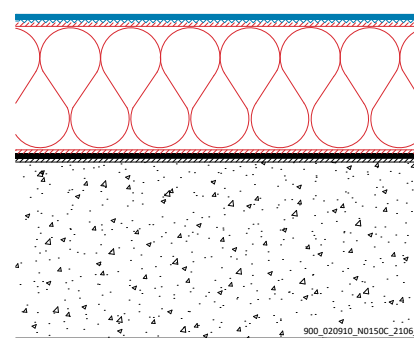

900_020910_N0150C_2106_en

- Sarnafil® TG 76 FSA, self-adhered
- Primer 600 / 780 (if required)
- New thermal Insulation, adhered
- SikaRoof® Board Adhesive, adhesive
- Existing bituminous roofing

ADHERED ROOF SYSTEM - EXISTING SYNTHETIC ROOFING

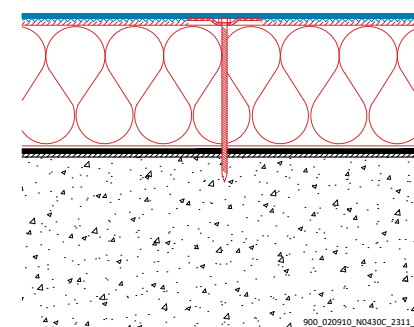

900_020910_N0430C_2311_en

- **System A**
- Sarnafil® TG 76 FSA, self-adhered
- Primer 600 / 780 (if required)
- New thermal Insulation, mechanically fastened
- Existing synthetic roofing
- **System B**
- Sarnafil® TG 76 Felt PS or Sarnafil® TG 76 E Felt PS, adhered
- Sarnacol®-2142 S, Adhesive
- New thermal Insulation, mechanically fastened
- Existing synthetic roofing

Note: In general, it is recommended to remove the existing synthetic or bituminous roofing before installing a new membrane.

ROOF REFURBISHMENT

SYNTHETIC / BITUMINOUS ROOFING SYSTEMS

Direct contact between Sarnafil® T roof waterproofing membranes and other roofing systems must be avoided.

Area dividers

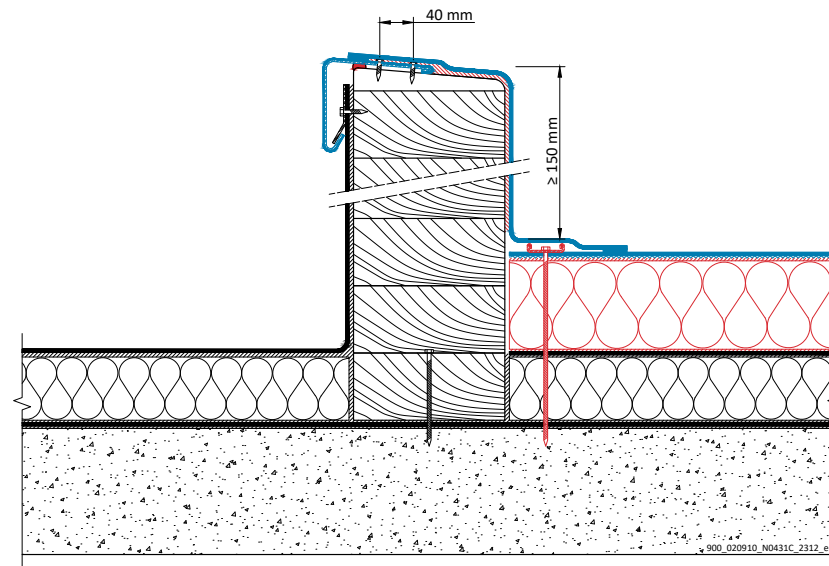

SikaRoof® Multitape for the sealing, joining, covering and temporary repair of single ply, bituminous and metal roofs since it bonds to the most common roofing materials in a short application time with a strong initial tack.

Connection Solution

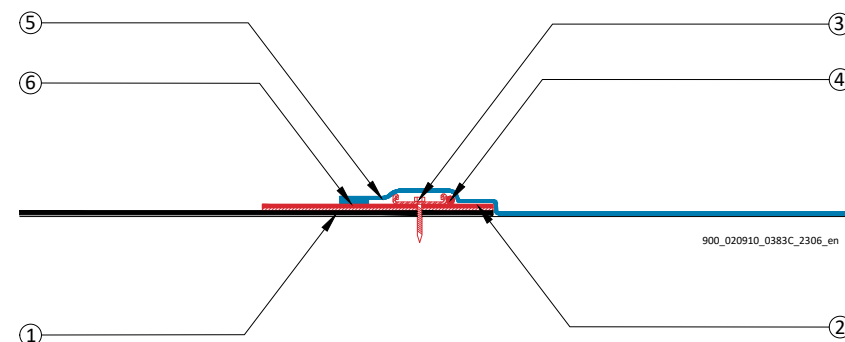

- | | |
|---|--|
| 1 Existing synthetic or bituminous roofing SikaRoof® Multitape, adhered proper mechanically fastened or adhered | 4 Sarnafil® T Welding Cord |
| 2 SikaRoof® Multitape, adhered | 5 Sarnafil® T membrane proper mechanically fastened or adhered |
| 3 Sarnabar® fastening profile with Sarnafast® fasteners | 6 Hot-air weld |

BITUMINOUS ROOFING SYSTEMS

Transition to bituminous roofs should be achieved using construction such as raised kerbs or area dividers.

If such details are not possible, a Sarnafil® T strip can be used for the transition between Sarnafil® T roof waterproofing membranes and the bituminous roof. Roof waterproofing membranes in the transition area must be mechanically fastened. This will prevent any damage or water infiltration that might occur in the old roof area from affecting the new area.

Transition to bituminous roofing system

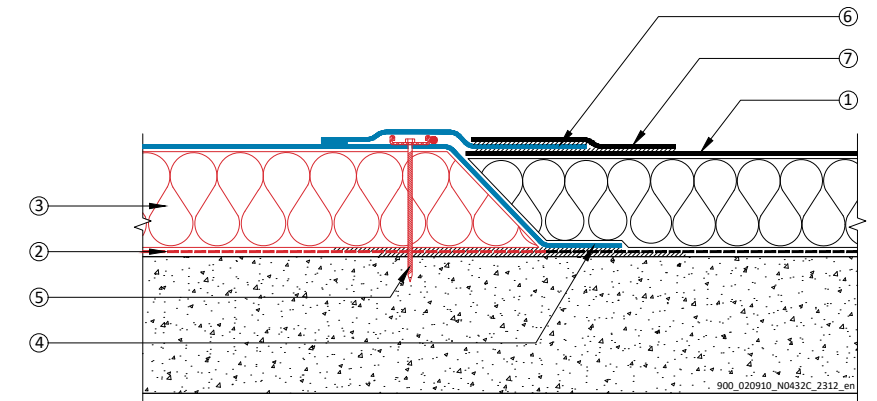

- | | |
|---|--|
| 1 Old bituminous roof | 6 Sarnafil® T (minimum thickness 1.50 mm or two layers) adhered with hot bitumen to old bituminous roof and hot-air welded to new Sarnafil® T membrane |
| 2 New vapour- control layer / barrier (bituminous membrane), adhered in the transition area | 7 Bituminous cover strip adhered to the Sarnafil® T and the old bituminous layer |
| 3 New thermal insulation | |
| 4 Sarnafil® T fully adhered to the bituminous vapour- control layer / barrier | |
| 5 Sarnabar® fastening profile with Sarnafast® fasteners and Sarnafil® T Welding Cord | |



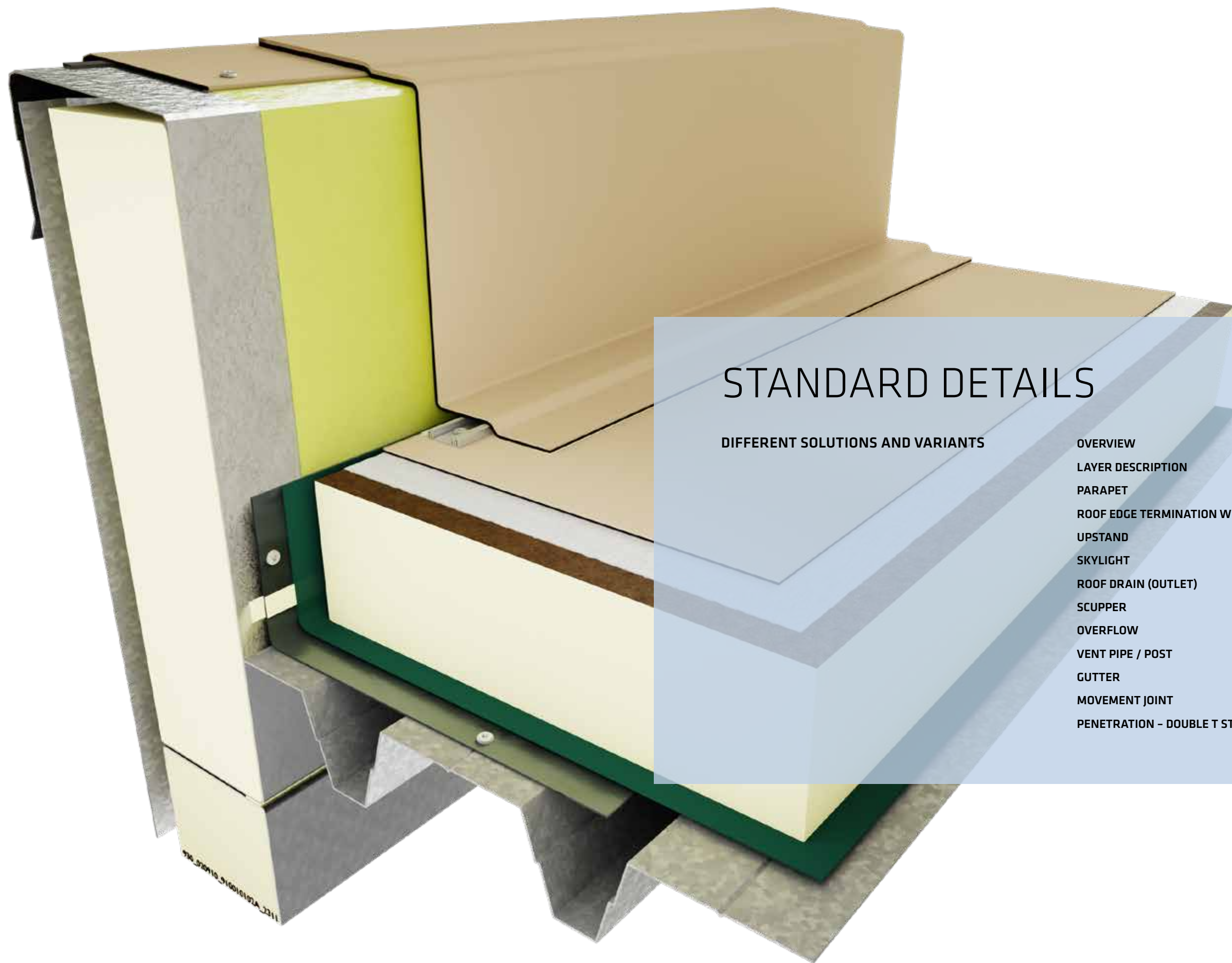

STANDARD DETAILS

DIFFERENT SOLUTIONS AND VARIANTS

OVERVIEW	190
LAYER DESCRIPTION	192
PARAPET	194
ROOF EDGE TERMINATION WITH GUTTER	198
UPSTAND	202
SKYLIGHT	206
ROOF DRAIN (OUTLET)	210
SCUPPER	214
OVERFLOW	218
VENT PIPE / POST	222
GUTTER	226
MOVEMENT JOINT	228
PENETRATION - DOUBLE T STEEL BEAM	232

STANDARD DETAILS OVERVIEW

PARAPET



Mechanically Fastened Roof System
Gravel Ballasted Roof System
Inverted Roof System
Utility Roof System
Green Roof System (Extensive / Intensive)
Adhered Roof System

ROOF EDGE TERMINATION WITH GUTTER



Mechanically Fastened Roof System
Gravel Ballasted Roof System
Inverted Roof System
Utility Roof System
Green Roof System (Extensive / Intensive)
Adhered Roof System

UPSTAND



Mechanically Fastened Roof System
Gravel Ballasted Roof System
Inverted Roof System
Utility Roof System
Green Roof System (Extensive / Intensive)
Adhered Roof System

SKYLIGHT



Mechanically Fastened Roof System
Gravel Ballasted Roof System
Inverted Roof System
Utility Roof System
Green Roof System (Extensive / Intensive)
Adhered Roof System

ROOF DRAIN (OUTLET)

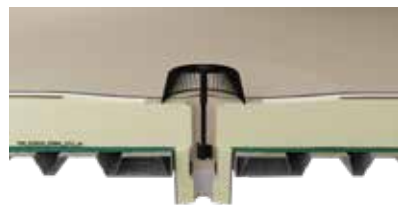

Mechanically Fastened Roof System
Gravel Ballasted Roof System
Inverted Roof System
Utility Roof System
Green Roof System (Extensive / Intensive)
Adhered Roof System



SCUPPER



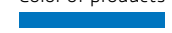

Mechanically Fastened Roof System
Gravel Ballasted Roof System
Inverted Roof System
Utility Roof System
Green Roof System (Extensive / Intensive)
Adhered Roof System

Legend

Color of products

 Roof waterproofing products
 Accessory products
 Other construction products

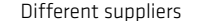
 Sika delivery program
 Sika delivery program
 Different suppliers

OVERFLOW



Mechanically Fastened Roof System
Gravel Ballasted Roof System
Inverted Roof System
Utility Roof System
Green Roof System (Extensive / Intensive)
Adhered Roof System

VENT PIPE / POST



Mechanically Fastened Roof System
Gravel Ballasted Roof System
Inverted Roof System
Utility Roof System
Green Roof System (Extensive / Intensive)
Adhered Roof System

GUTTER



Mechanically Fastened Roof System
Adhered Roof System

MOVEMENT JOINT



Mechanically Fastened Roof System
Gravel Ballasted Roof System
Inverted Roof System
Adhered Roof System

PENETRATION - DOUBLE T STEEL BEAM

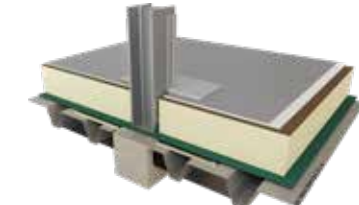

Mechanically Fastened Roof System
Gravel Ballasted Roof System
Inverted Roof System
Utility Roof System
Green Roof System (Extensive / Intensive)
Adhered Roof System

DRAWING MUST ALWAYS BE REVIEWED BY A DESIGN SPECIALIST AND IF NECESSARY MODIFIED TO ENSURE SUITABILITY FOR THE SPECIFIC APPLICATION

The information contained herein and any other advice are given in good faith based on Sika's current knowledge and experience of the products when properly stored, handled and applied under normal conditions in accordance with Sika's recommendations. The information only applies to the application(s) and product(s) expressly referred to herein and is based on laboratory tests which do not replace practical tests. In case of changes in the parameters of the application, such as changes in substrates etc., or in case of a different application, consult Sika's Technical Service prior to using Sika products. The information contained herein does not relieve the user of the products from testing them for the intended application and purpose. All orders are accepted subject to our current terms of sale and delivery. Users must always refer to the most recent issue of the local Product Data Sheet for the product concerned, copies of which will be supplied on request.

LAYER DESCRIPTION

SUBSTRATES

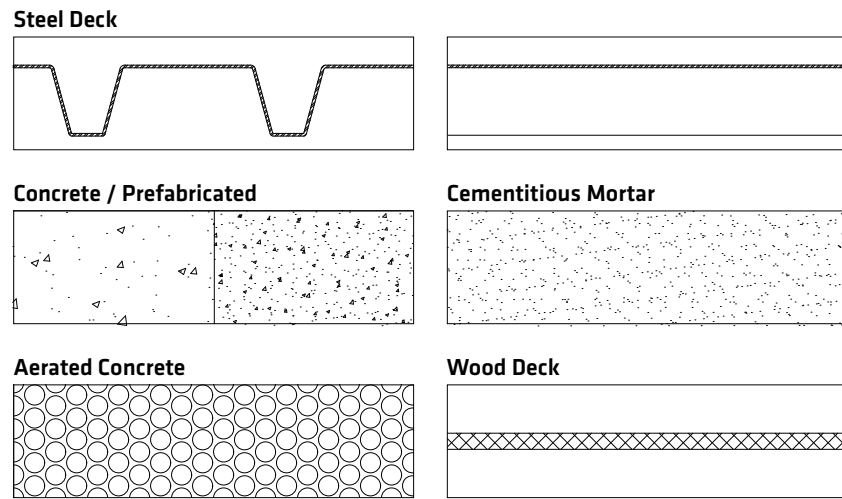

VAPOUR- CONTROL LAYER / BARRIER

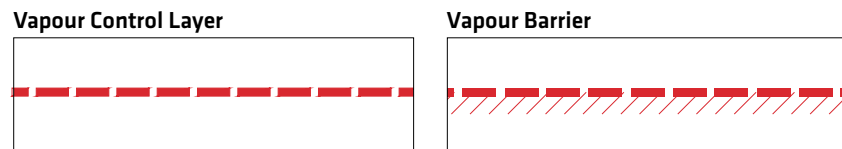

ADHESIVE

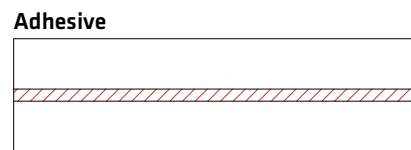

THERMAL INSULATION

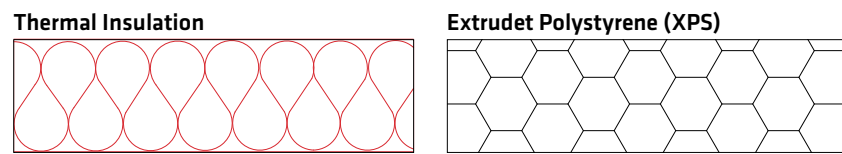

INTERMEDIATE LAYERS

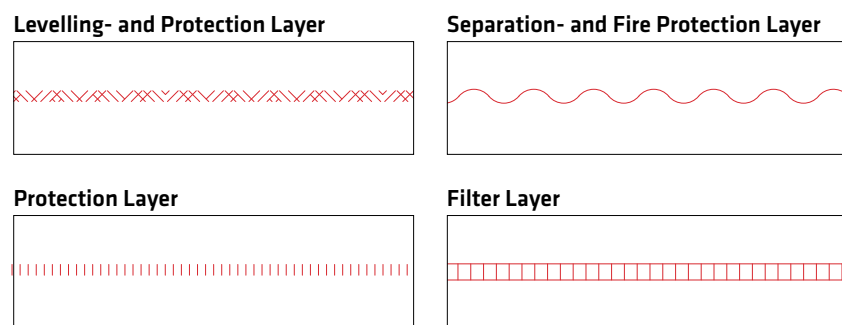

INTERMEDIATE LAYERS

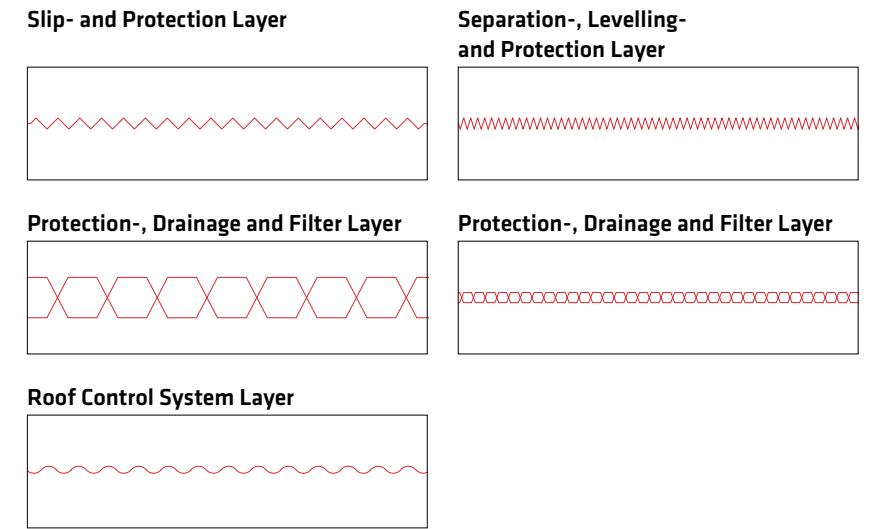

ROOF WATERPROOFING

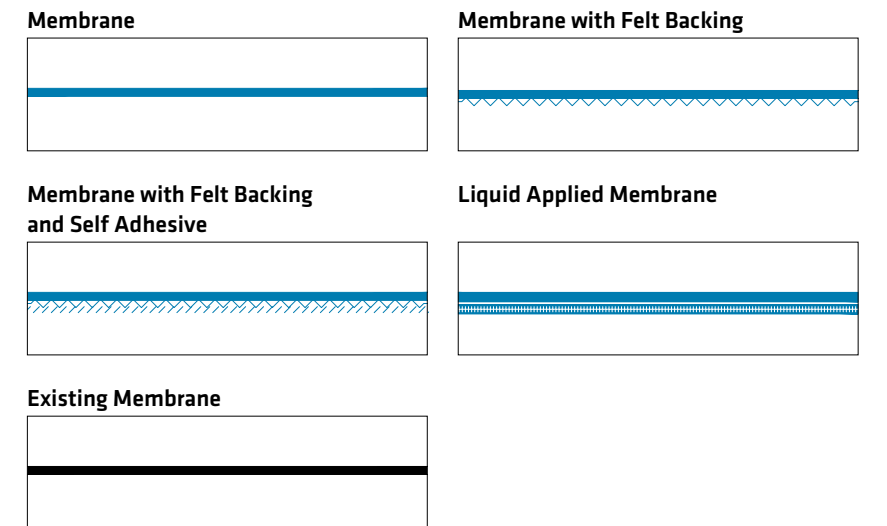

BALLAST

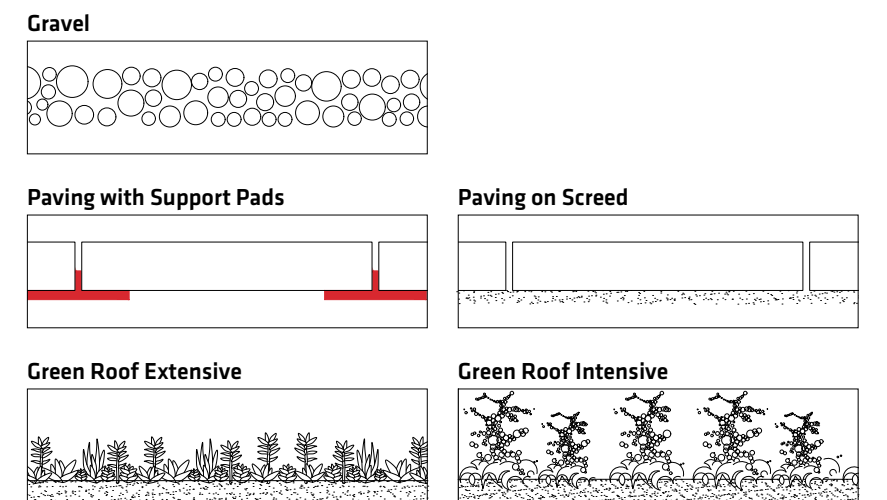

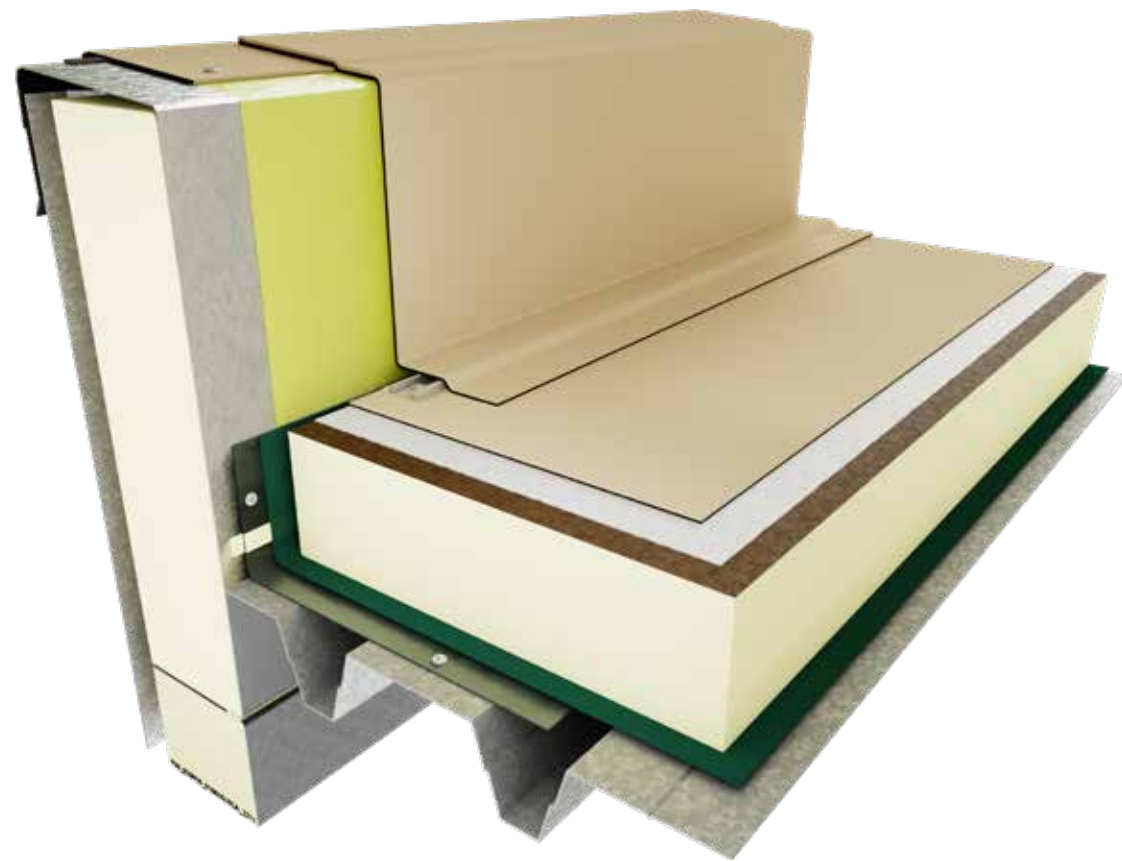

PLANNING INFORMATION

Perimeter flashings are formed using strips of Sarnafil® T membrane. The flashing strips are to be fully adhered with Sarnacol® T-660 adhesive to the substrate and welded to the field sheet. The substrate must be free of ridges, and the flashing must be attached with a good adhesive bond.

The fully adhered flashing strips can be either hot welded to mechanically fastened Sarnafil® T Metal Sheet or to be covered with mechanically fastened metal clip and metal capping.

A counter flashing should be installed on utility roof systems to protect the membrane.

At all upstands and penetrations wider than 50 cm Sarnafil® T membrane must be secured with Sarnabar® fastening profile either to the horizontal or vertical surface.

001.01.02 – Sarnafil® T Metal Sheet – Adhered on Metal Parapet Element – Mechanically Fastened Roof System

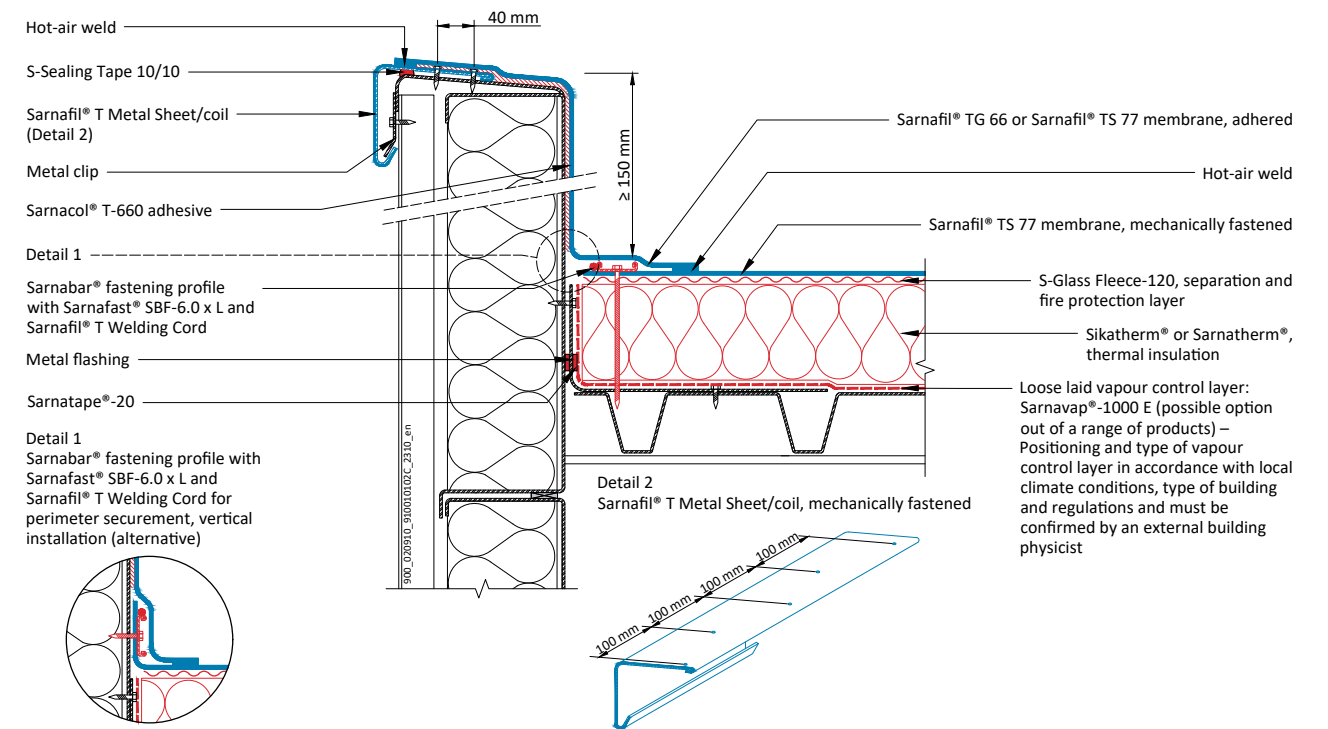

020.01.02 – Sarnafil® T Metal Sheet – Adhered on Concrete Parapet – Gravel Ballasted Roof System

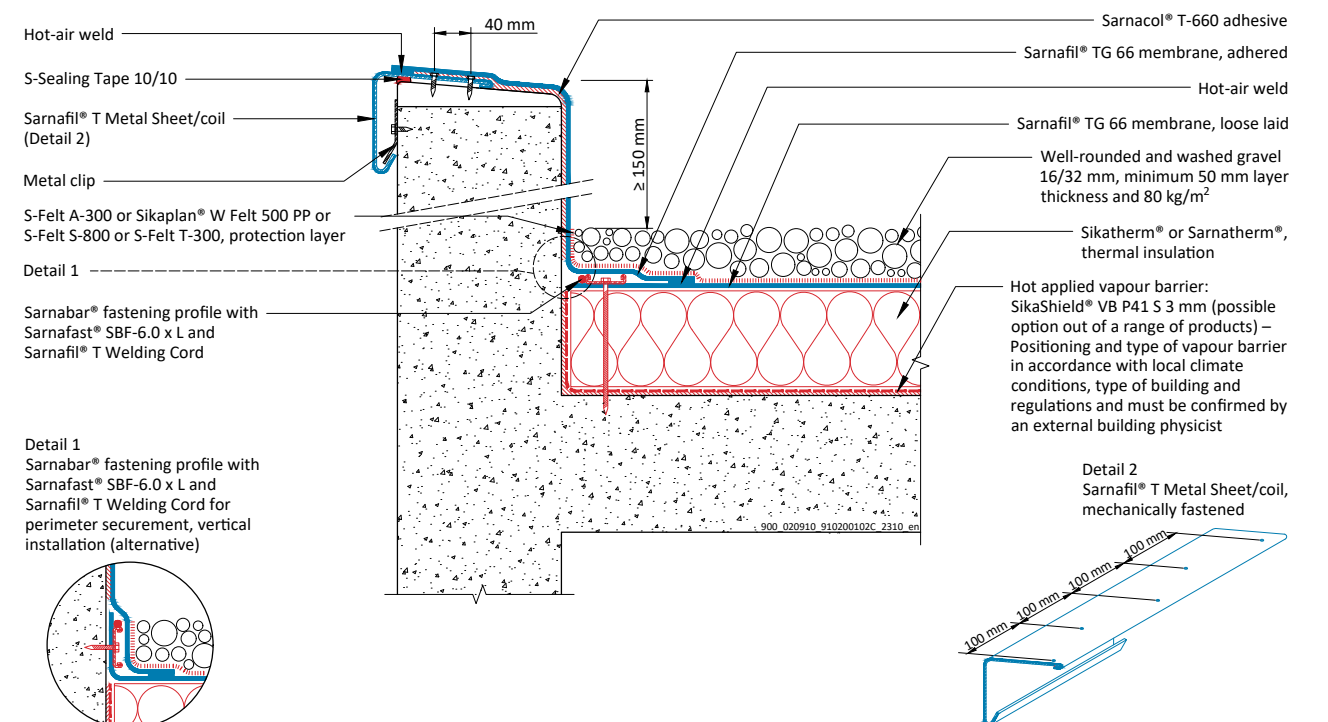

STANDARD DETAILS

PARAPET

030.01.04 – Metal Capping – Adhered on Concrete Parapet – Inverted Roof System

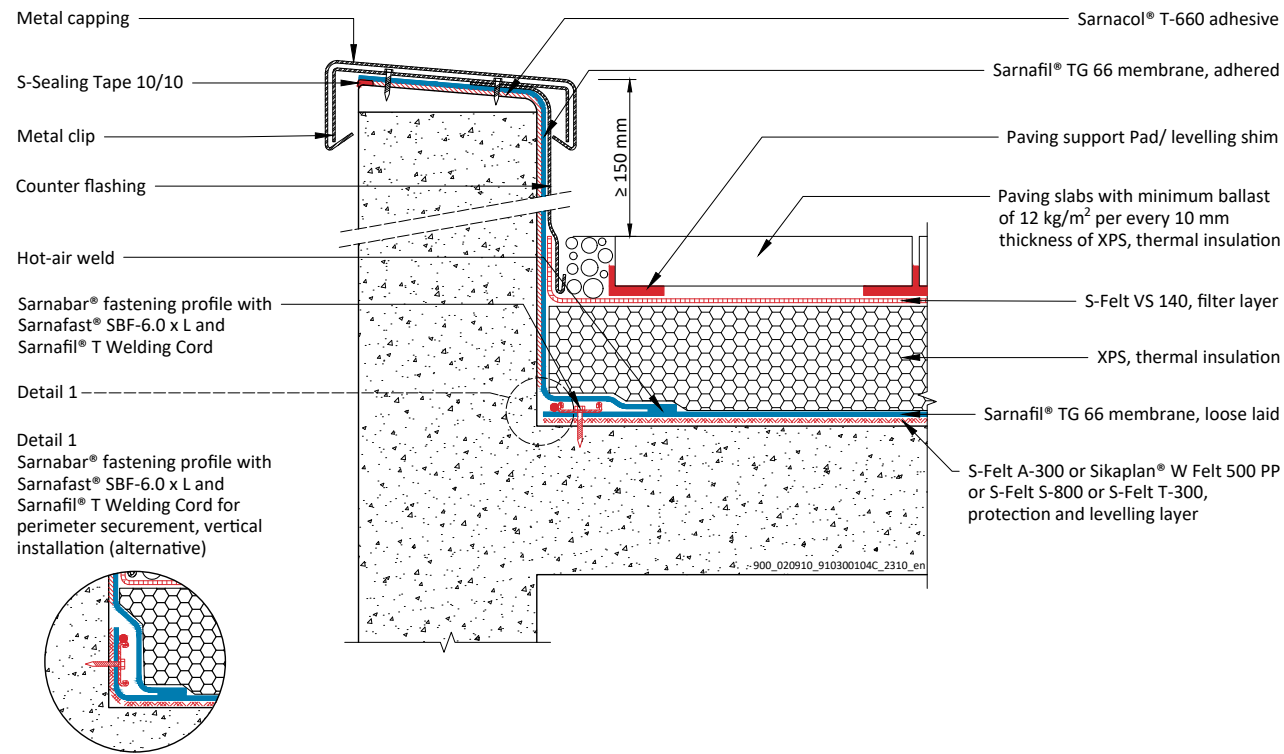

050.01.04 – Metal Capping – Adhered on Concrete Parapet – Green Roof System (Extensive / Intensive)

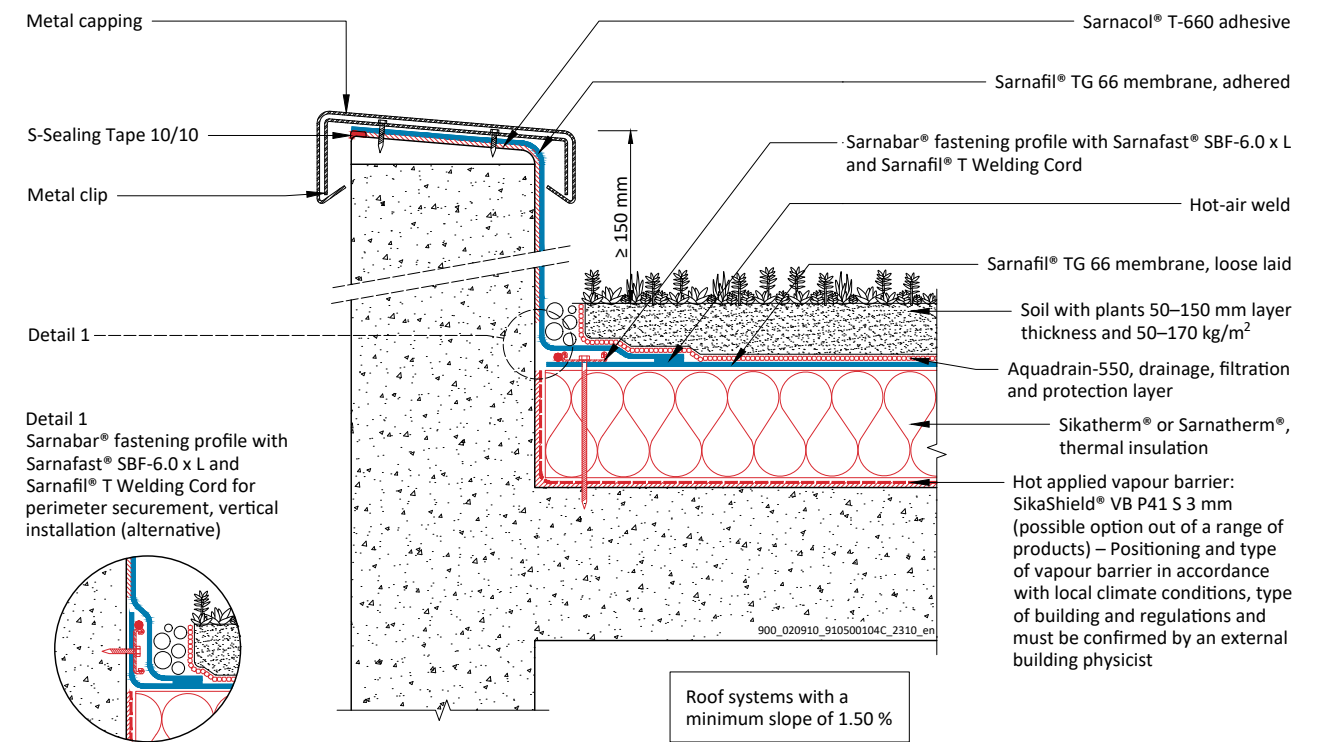

040.01.02 – Metal Capping – Adhered on Concrete Parapet – Utility Roof System

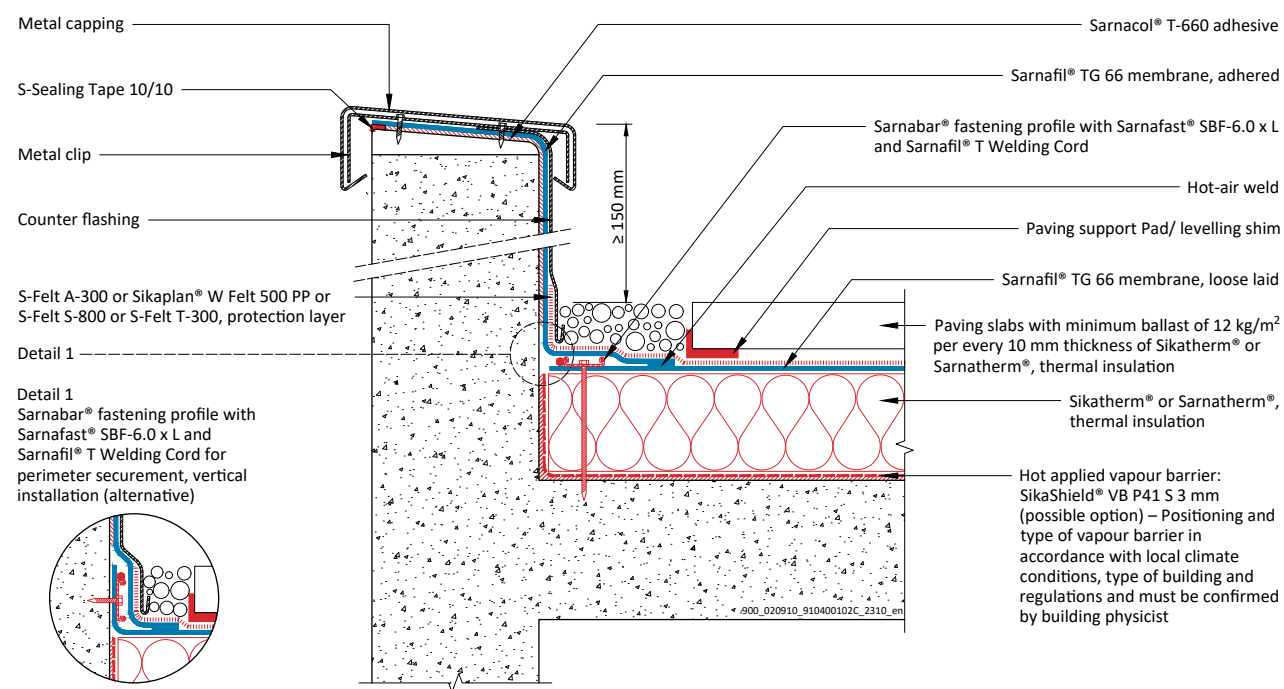

060.01.01 – Sarnafil® T Metal Sheet – Adhered on Concrete Parapet – Adhered Roof System

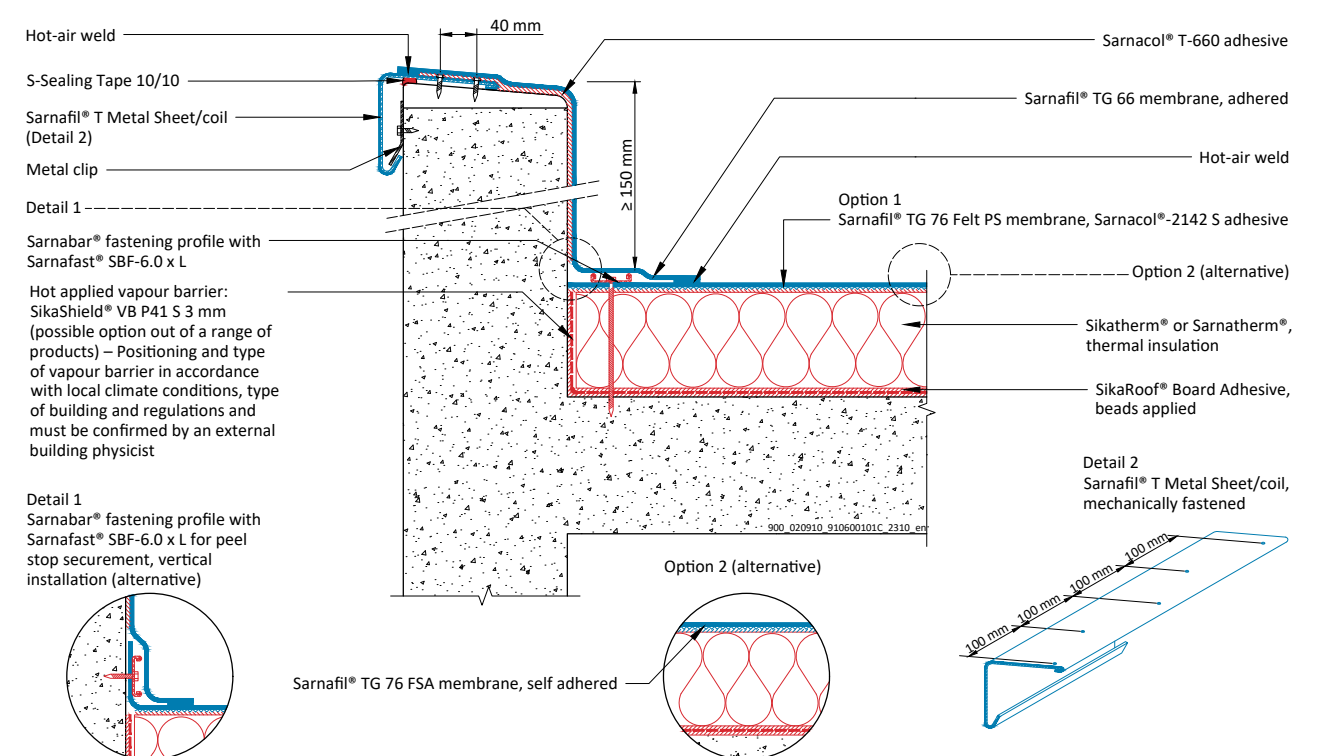

ROOF EDGE TERMINATION WITH GUTTER



PLANNING INFORMATION

Mechanically fastened, loosely laid or adhered Sarnafil® T roof waterproofing membrane hot welded to mechanically fastened Sarnafil® T Metal Sheet.

Sarnafil® T Gravel stop bracket and S-Gravelstop Profile to be installed in combination with ballasted roof systems.

001.02.01 – Mechanically Fastened Roof System

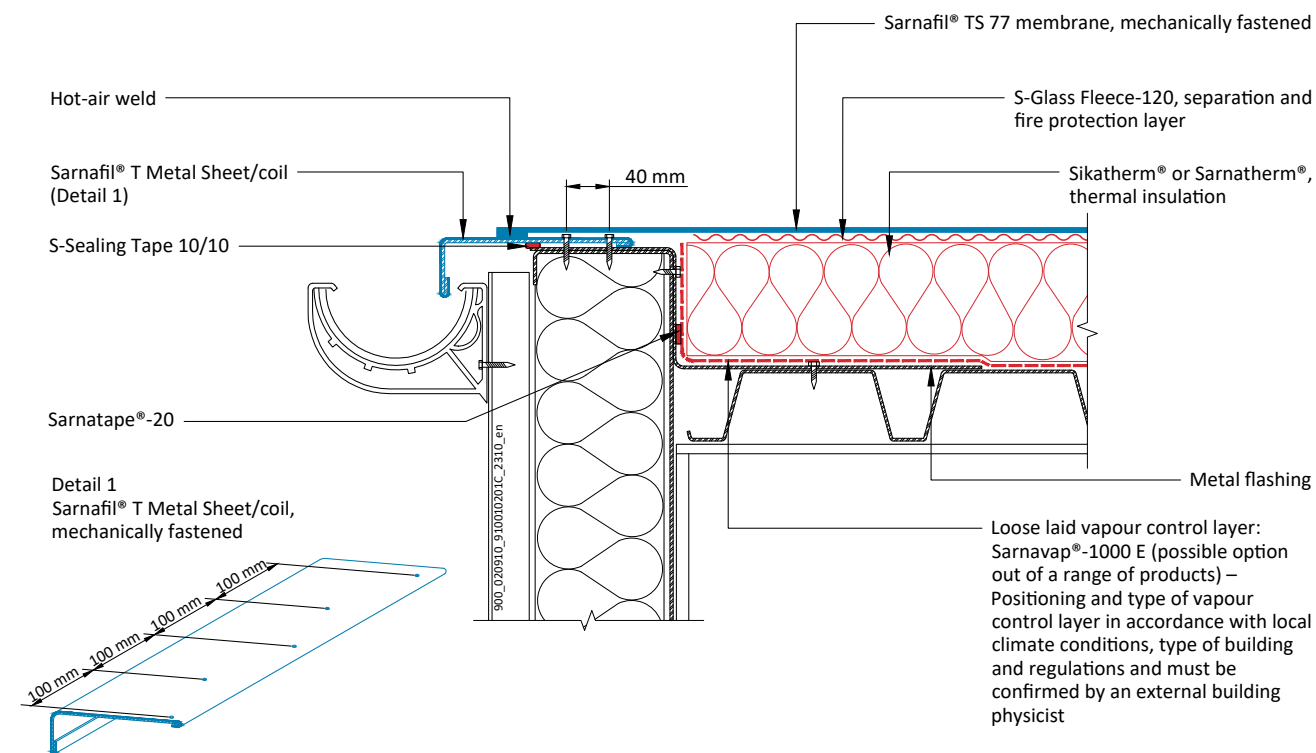

020.02.01 – Gravel Ballasted Roof System

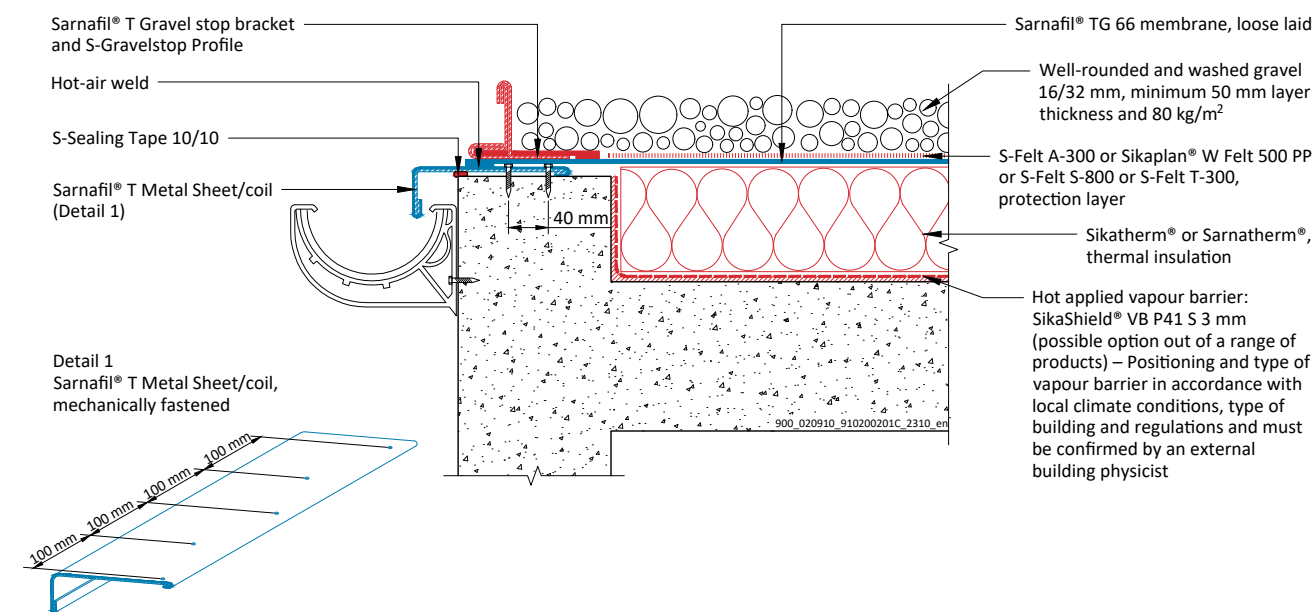

ROOF EDGE TERMINATION WITH GUTTER

030.02.01 – Inverted Roof System

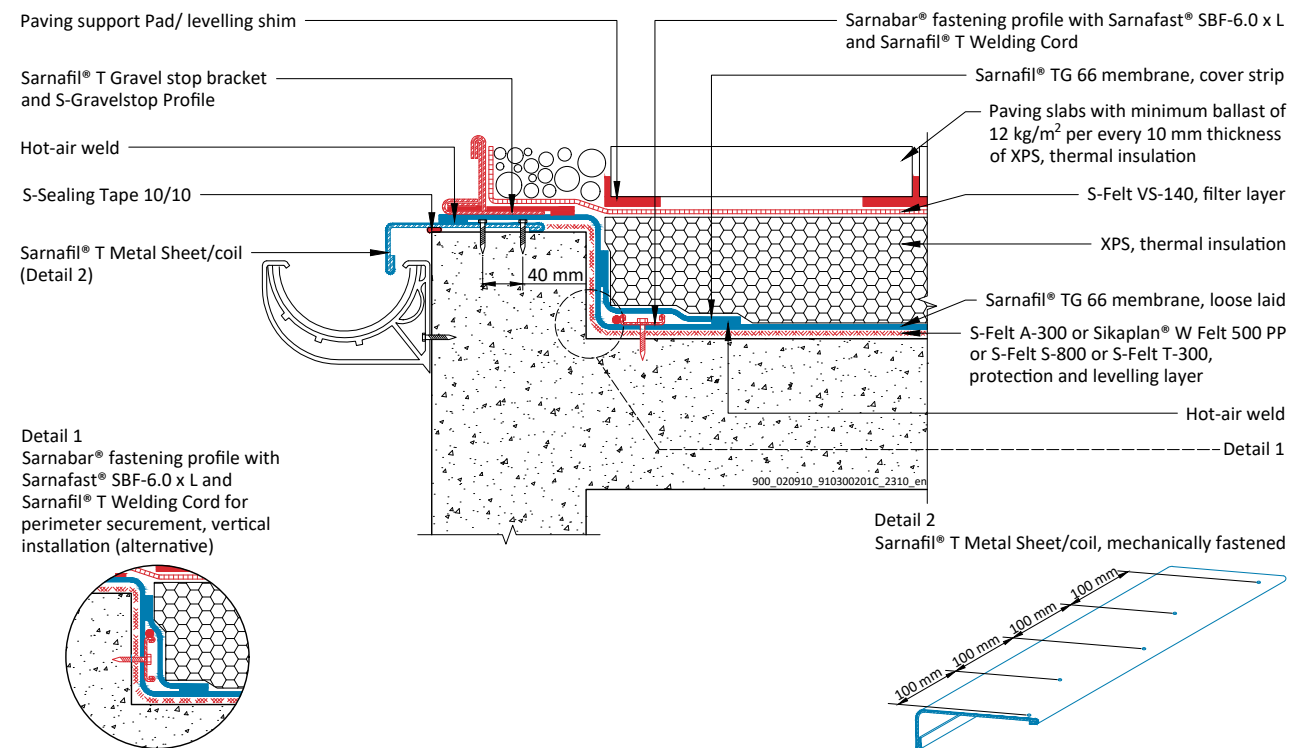

050.02.01 – Green Roof System (Extensive / Intensive)

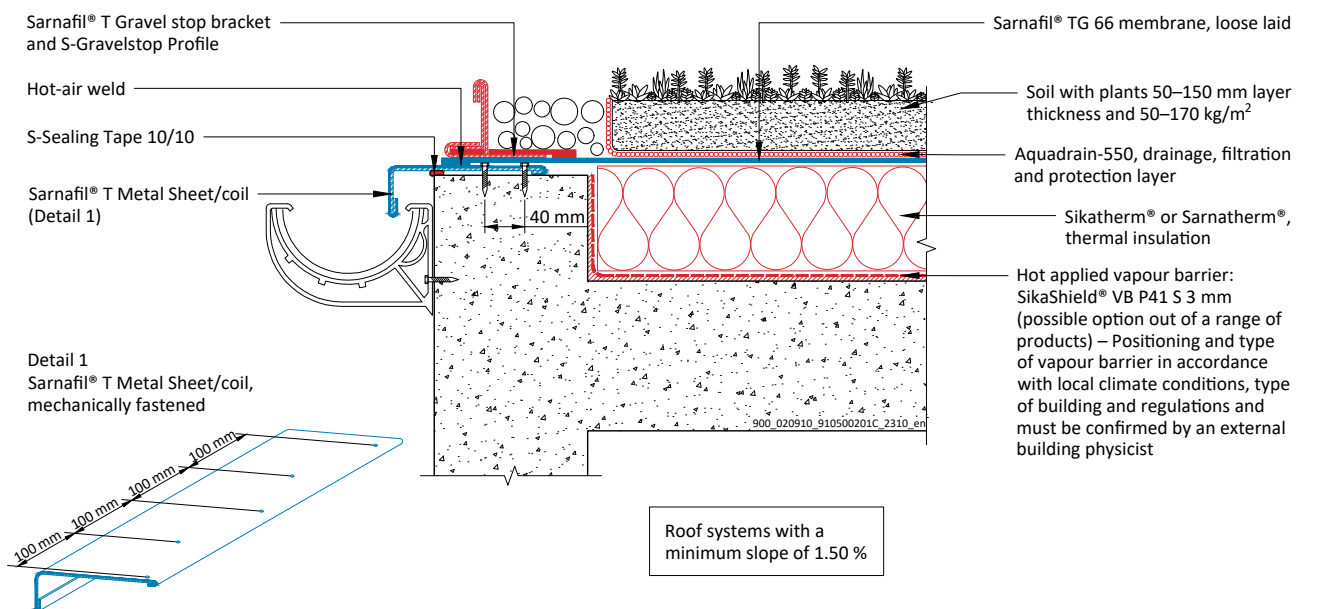

040.02.01 – Utility Roof System

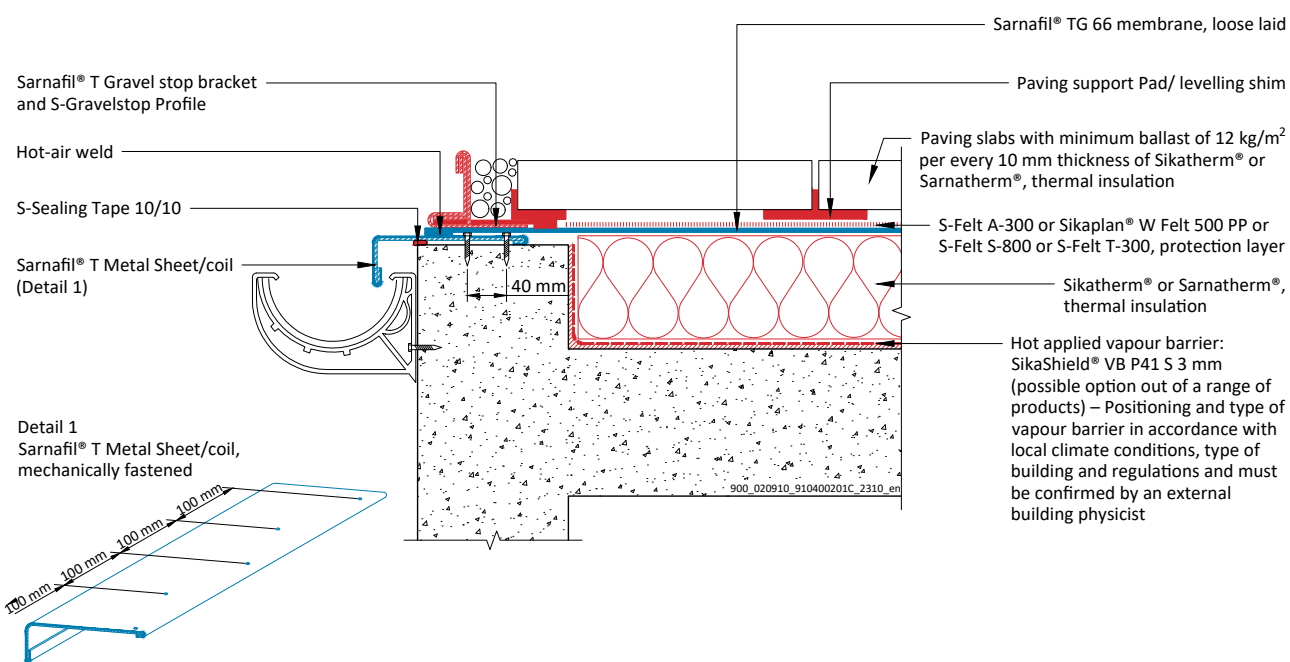

060.02.01 – Adhered Roof System

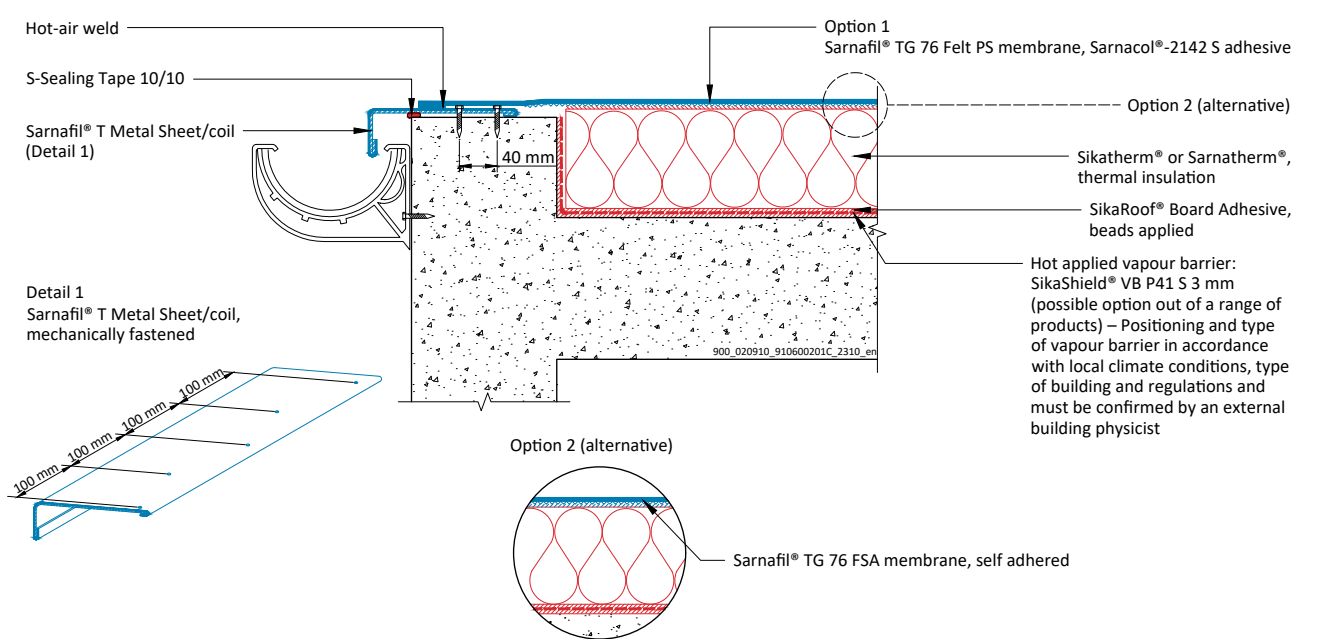

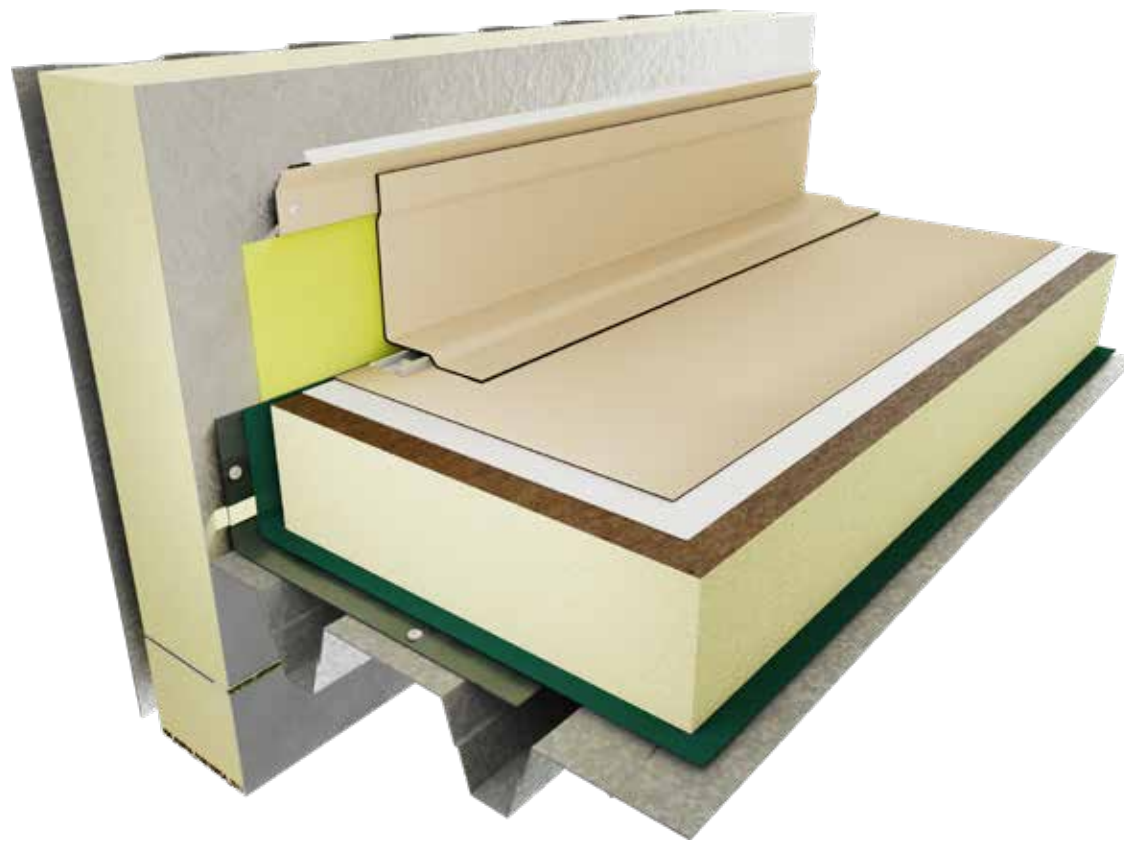

PLANNING INFORMATION

Perimeter flashings are formed using strips of Sarnafil® T membrane. The flashing strips are to be fully adhered with Sarnacol® T-660 adhesive to the substrate and welded to the field sheet. The substrate must be free of ridges, and the flashing must be attached with a good adhesive bond.

The fully adhered flashing strips can be either hot welded to mechanically fastened Sarnafil® T Metal Sheet or to be covered with mechanically fastened counter flashing. Top end of Sarnafil® T Metal Sheet or counter flashing to be sealed, using Sarnaplast®-2235 or Sikaflex®-11 FC Purform®.

A counter flashing should be installed on utility roof systems to protect the membrane.

At all upstands and penetrations wider than 50 cm Sarnafil® T membrane must be secured with Sarnabar® fastening profile either to the horizontal or vertical surface.

001.03.02 – Sarnafil® T Metal Sheet – Adhered on Metal Wall Element – Mechanically Fastened Roof System

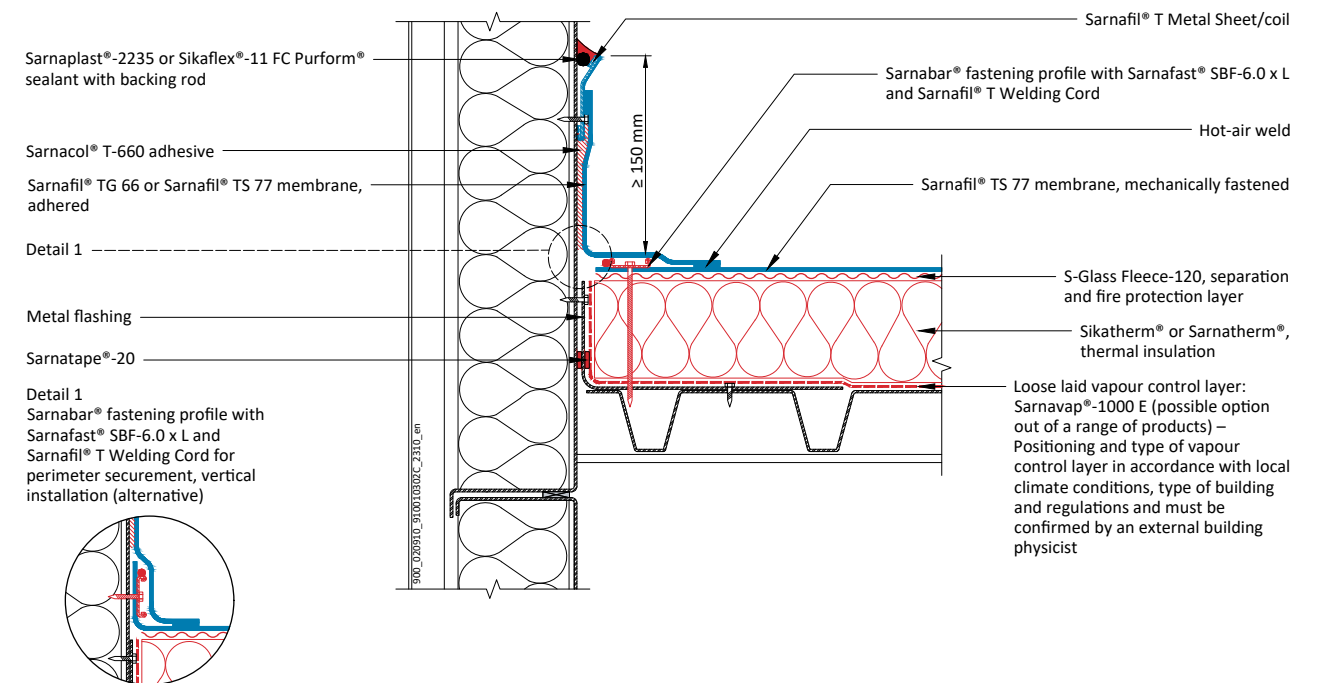

020.03.02 – Sarnafil® T Metal Sheet – Adhered on Concrete Wall – Gravel Ballasted Roof System

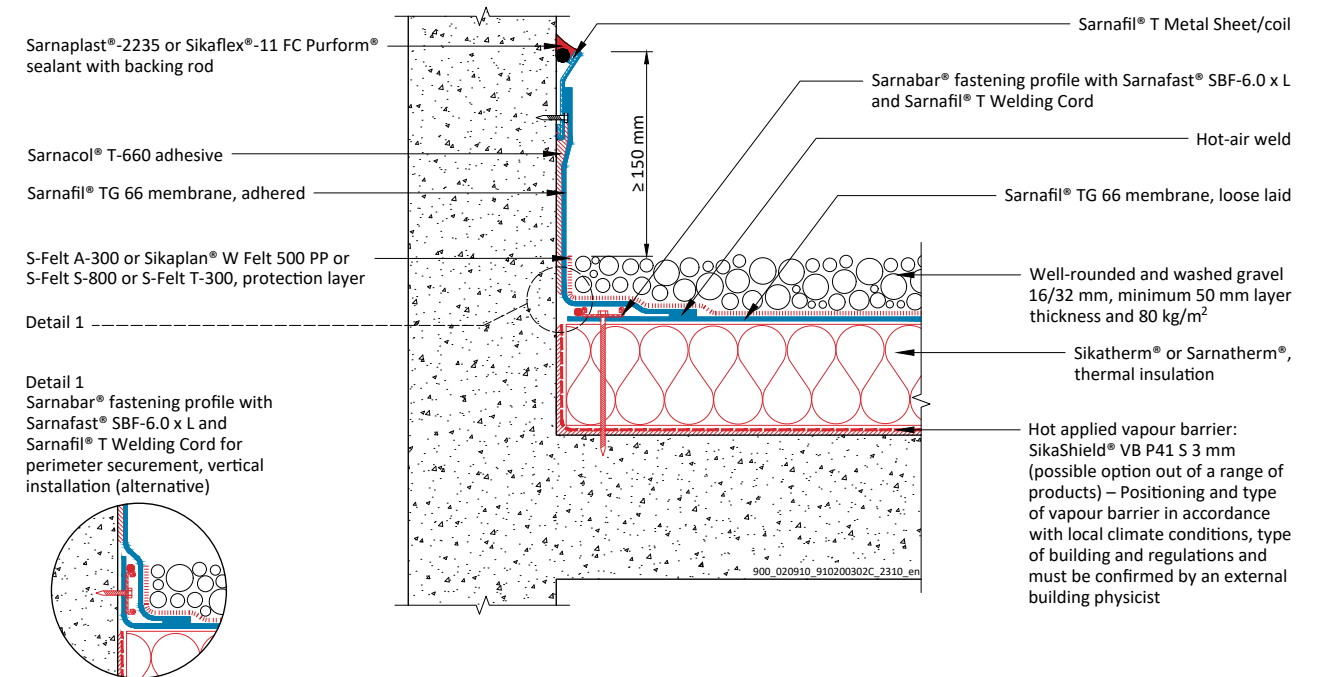

STANDARD DETAILS

UPSTAND

030.03.03 – Counter Flashing – Adhered on Concrete Wall – Inverted Roof System

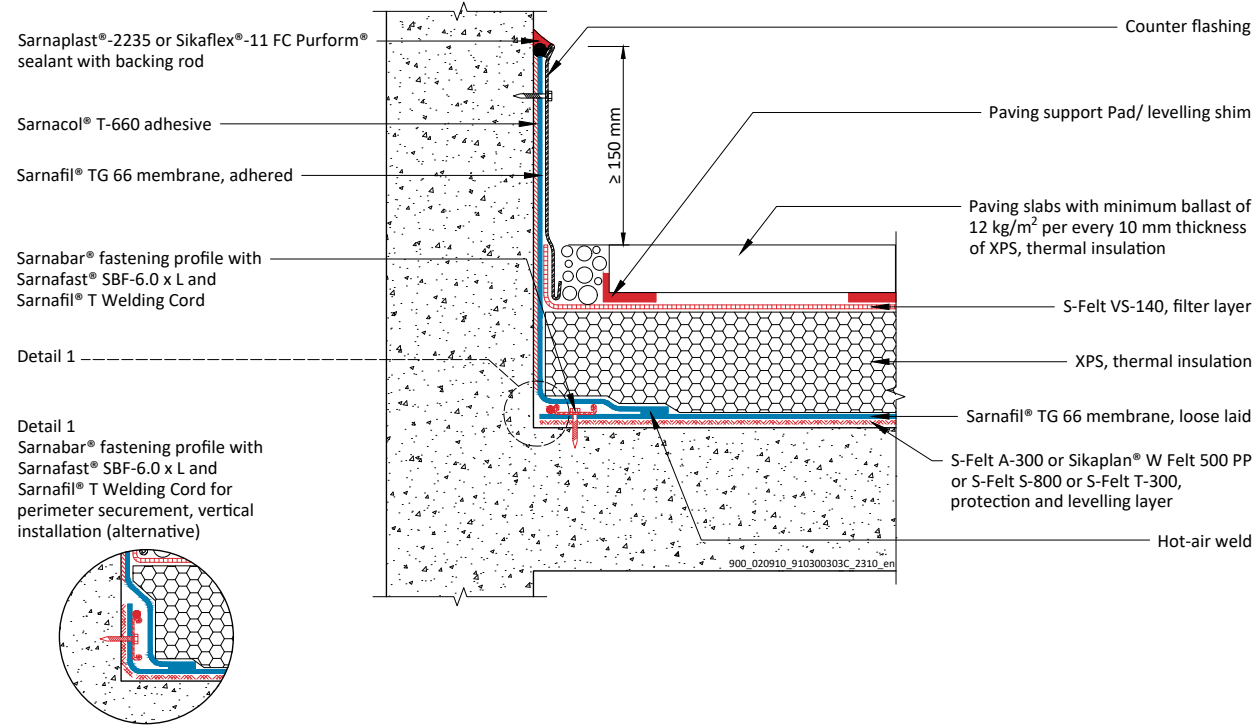

050.03.03 – Counter Flashing – Adhered on Concrete Wall – Green Roof System (Extensive / Intensive)

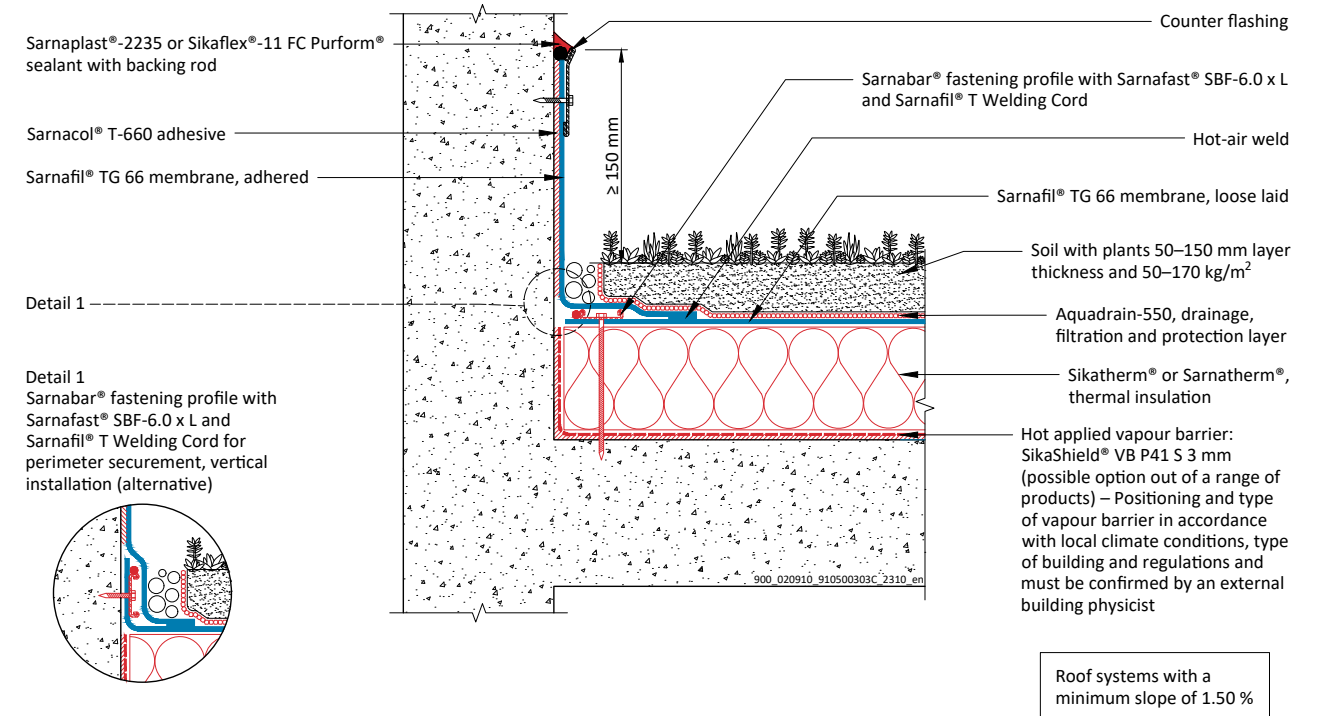

040.03.01 – Counter Flashing – Adhered on Concrete Wall – Utility Roof System

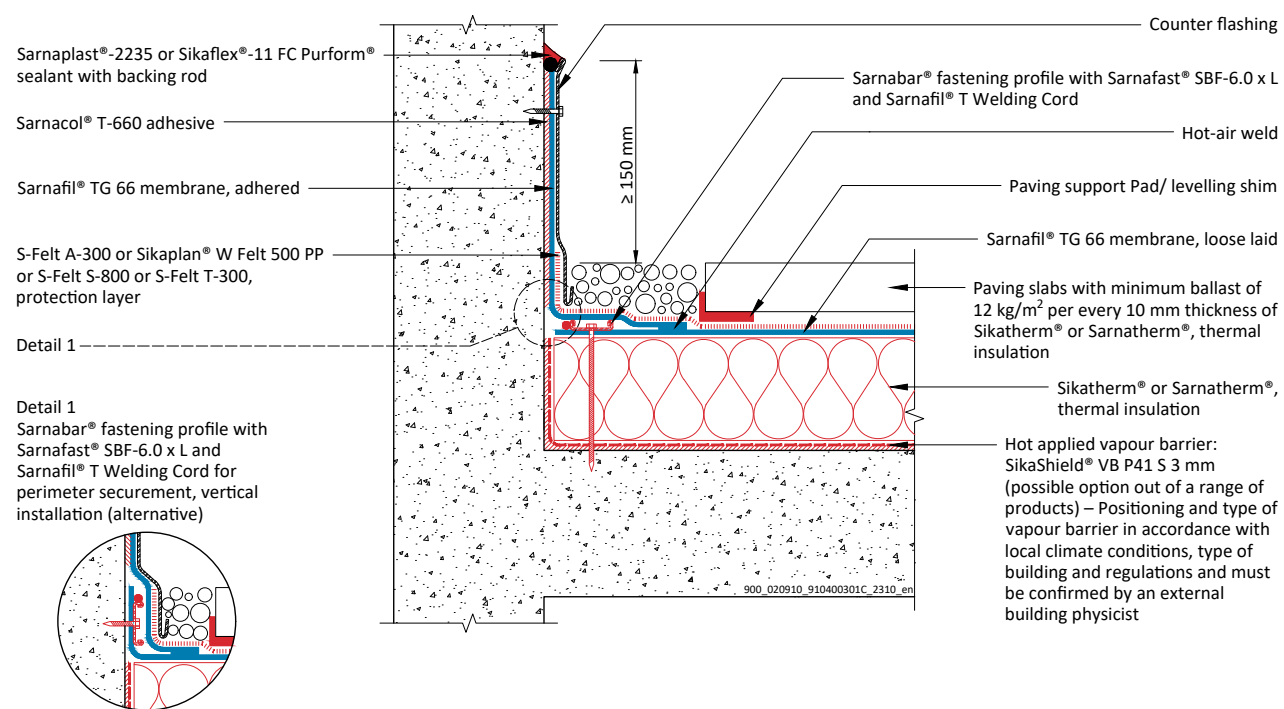

060.03.01 – Sarnafil® T Metal Sheet – Adhered on Concrete Wall – Adhered Roof System

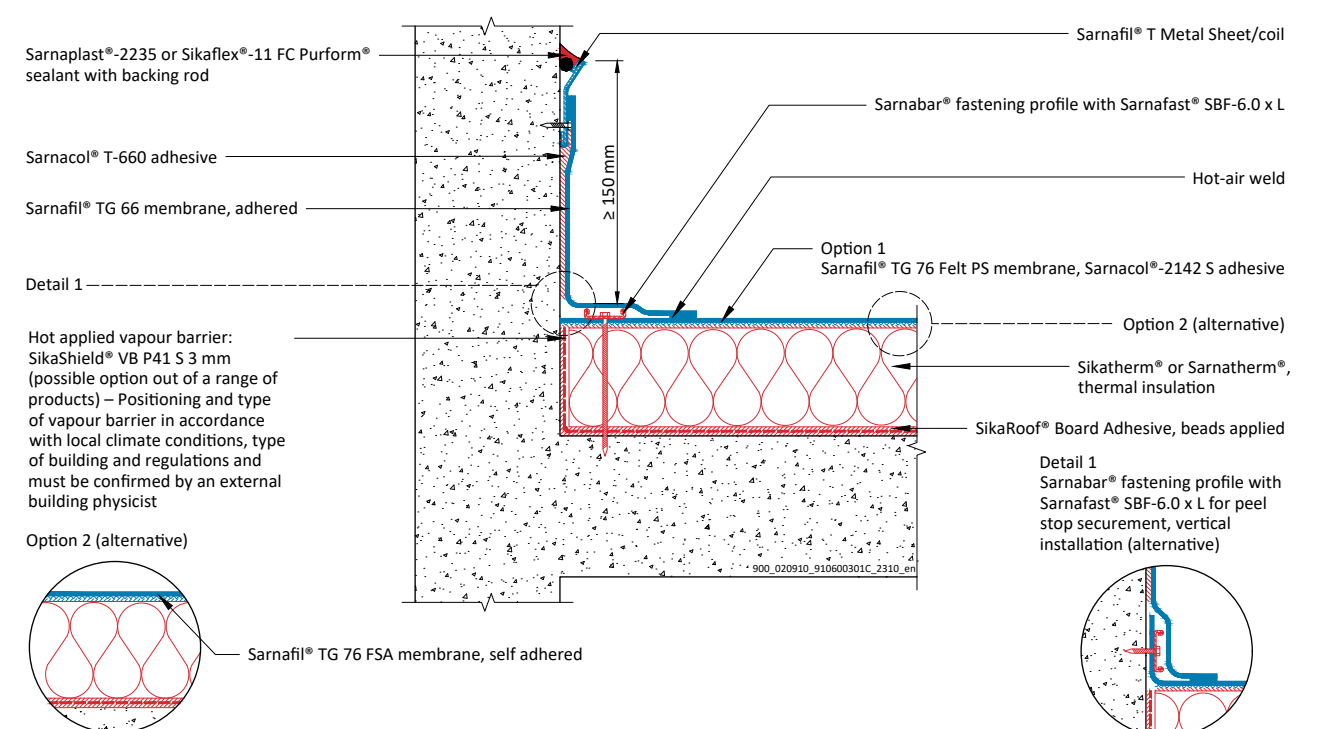

STANDARD DETAILS

SKYLIGHT

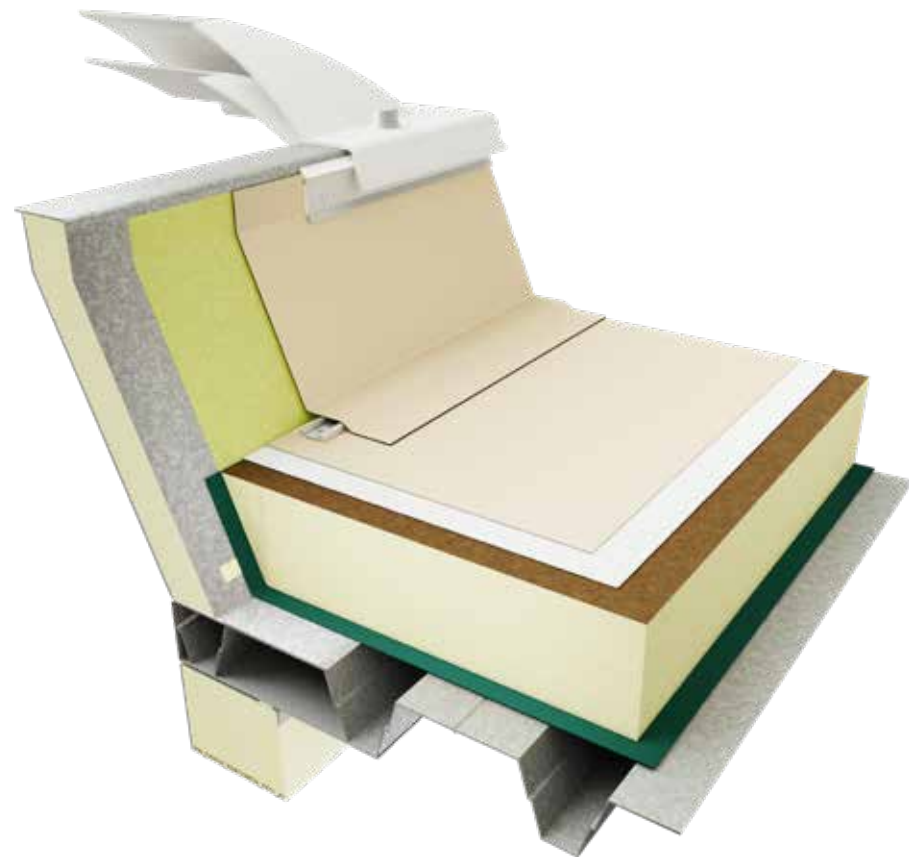

PLANNING INFORMATION

Skylight flashings are formed using strips of Sarnafil® T membrane. The flashing strips are to be fully adhered with Sarnacol® T-660 adhesive to the substrate and welded to the field sheet. The substrate must be free of ridges, and the flashing must be attached with a good adhesive bond.

The fully adhered flashing strips to be covered with mechanically fastened metal termination profile. Top end of profile to be sealed, using Sarnaplast®-2235 or Sikaflex®-11 FC Purform®.

A counter flashing should be installed on utility roof systems to protect the membrane.

At all upstands and penetrations wider than 50 cm Sarnafil® T membrane must be secured with Sarnabar® fastening profile either to the horizontal or vertical surface.

001.04.02 – Sealed – Adhered on Skylight System – Mechanically Fastened Roof System

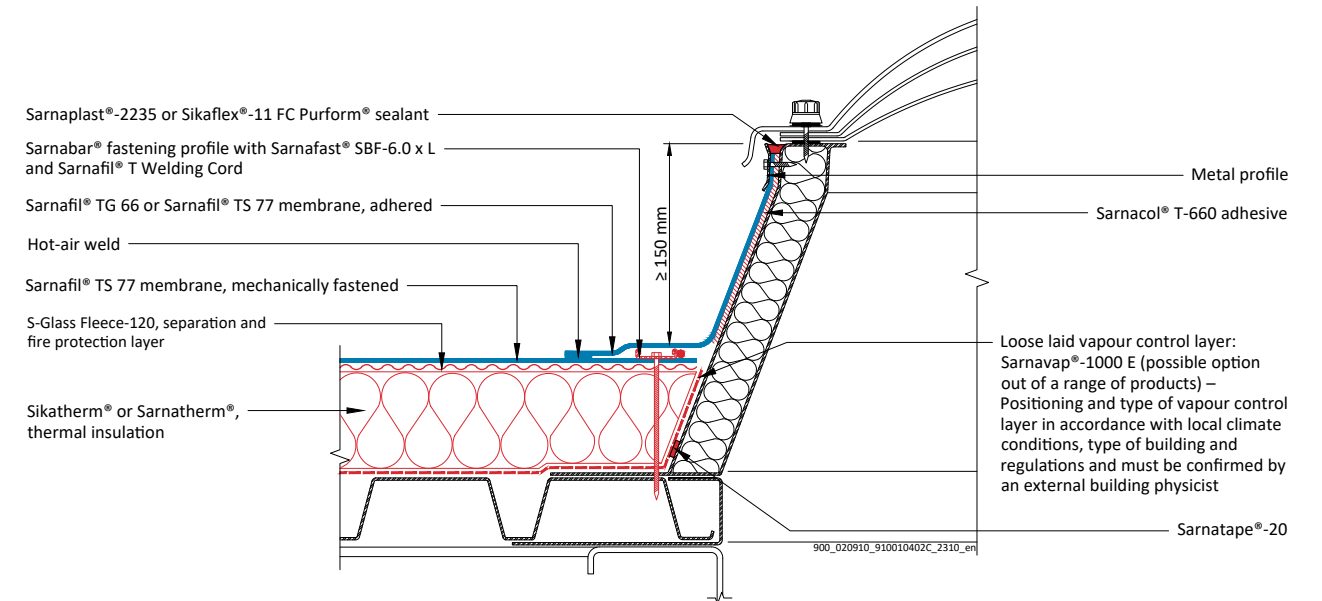

020.04.02 – Sealed – Adhered on Skylight System – Gravel Ballasted Roof System

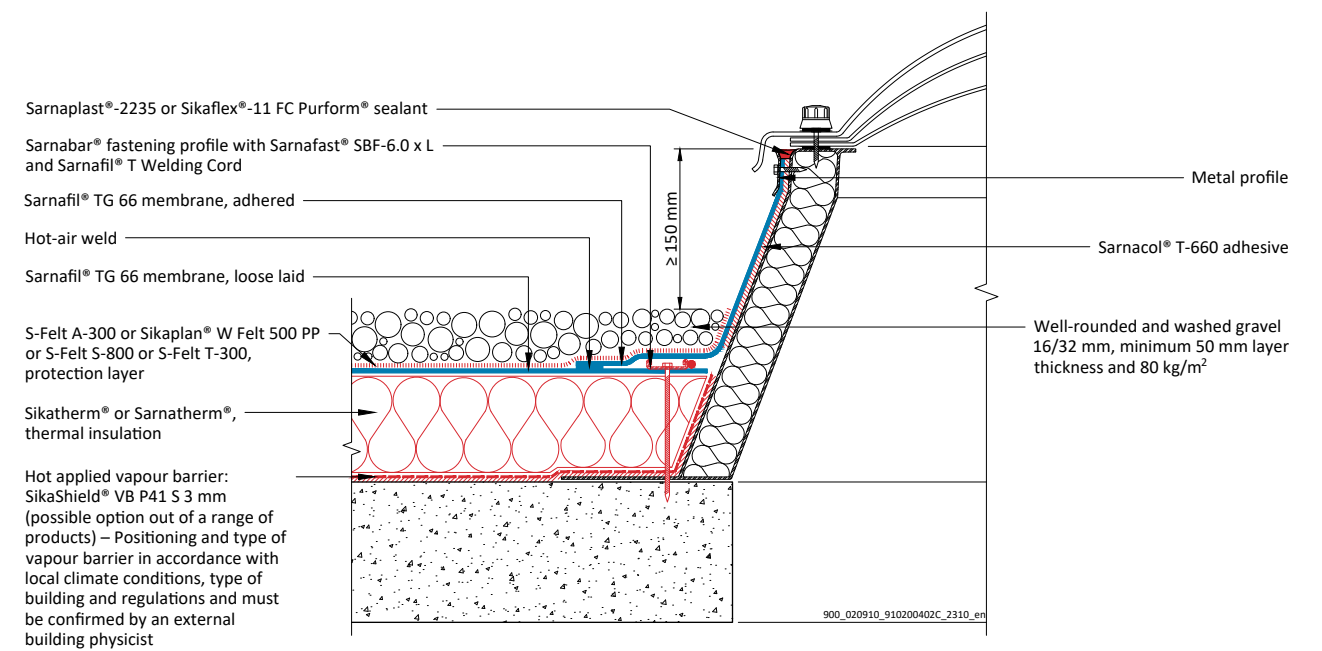

STANDARD DETAILS

SKYLIGHT

030.04.02 – Sealed – Adhered on Skylight System – Inverted Roof System

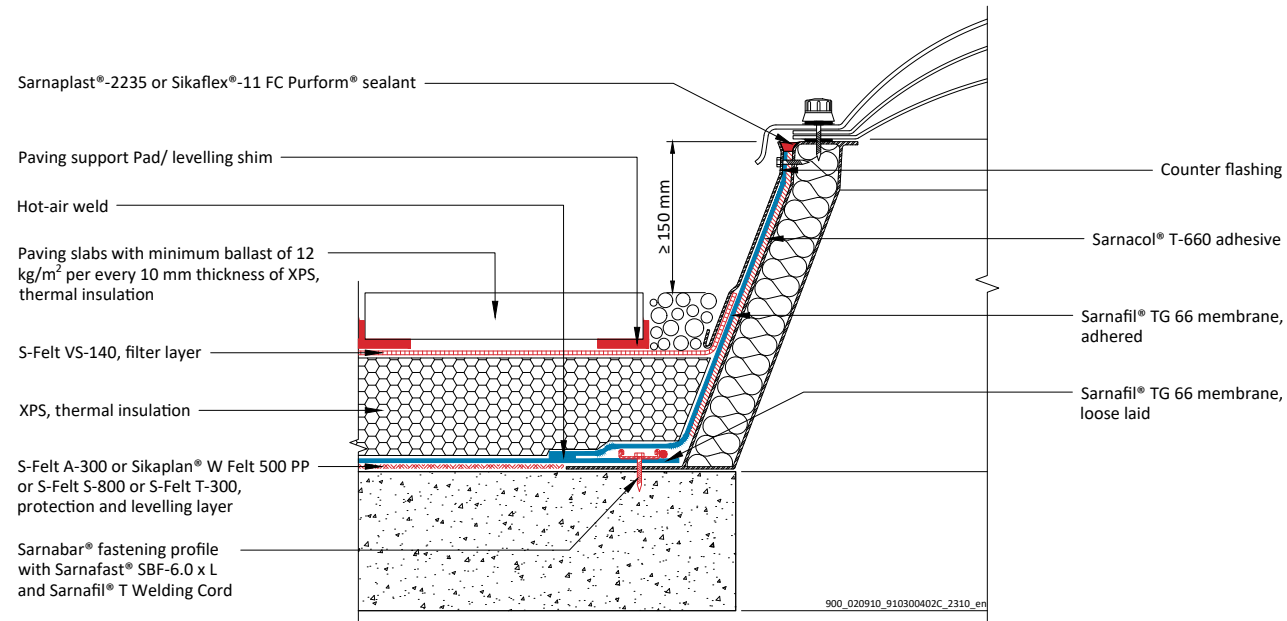

050.04.02 – Sealed – Adhered on Skylight System – Green Roof System (Extensive / Intensive)

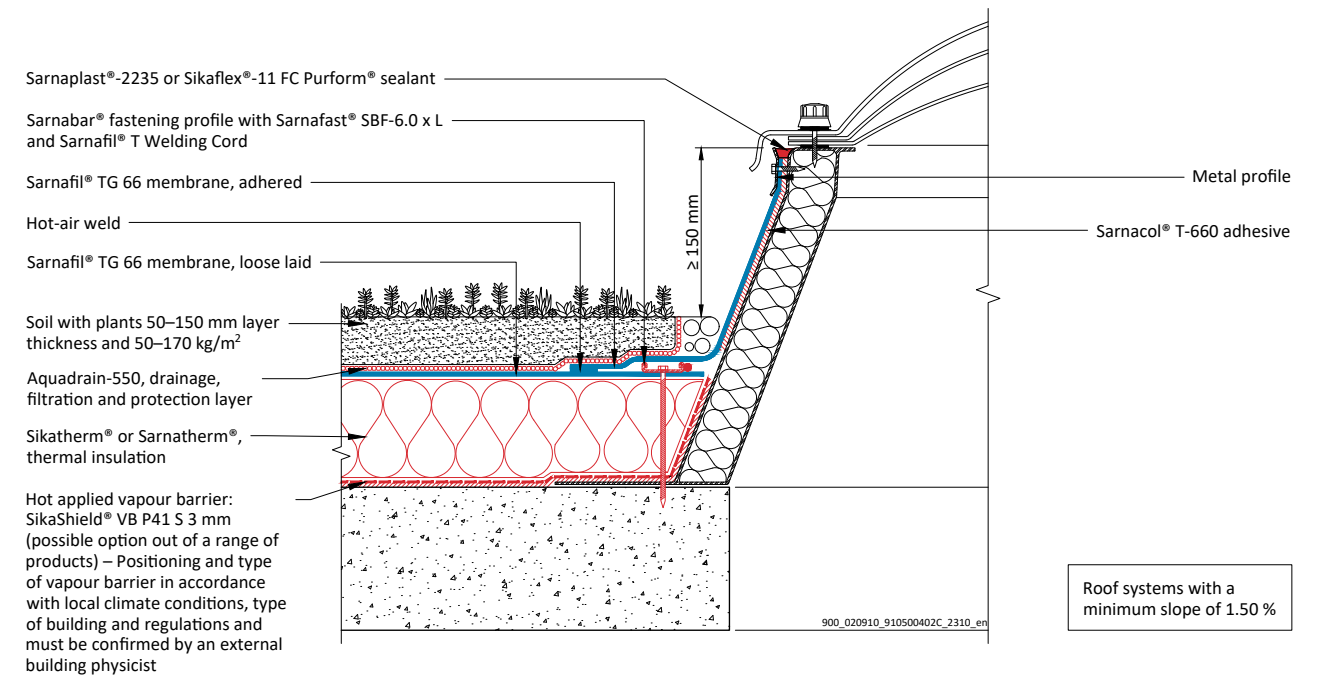

040.04.02 – Sealed – Adhered on Skylight System – Utility Roof System

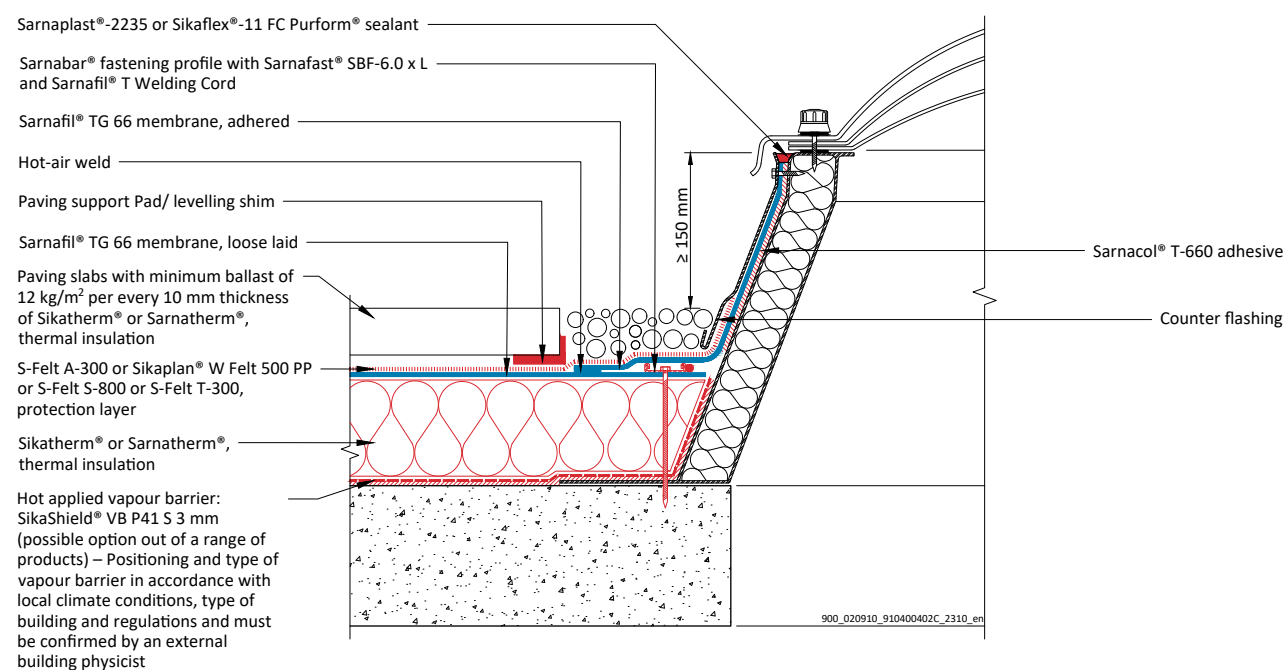

060.04.01 – Sealed – Adhered on Skylight System – Adhered Roof System

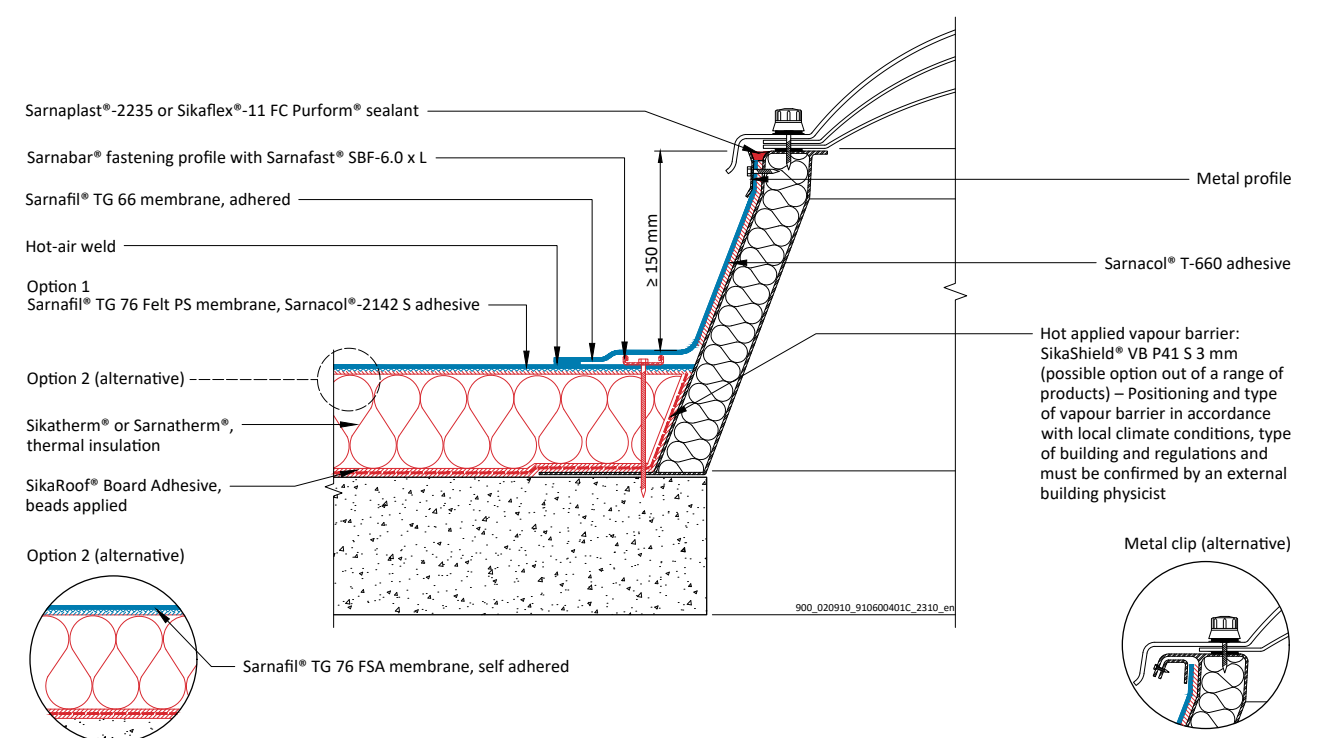

ROOF DRAIN (OUTLET)

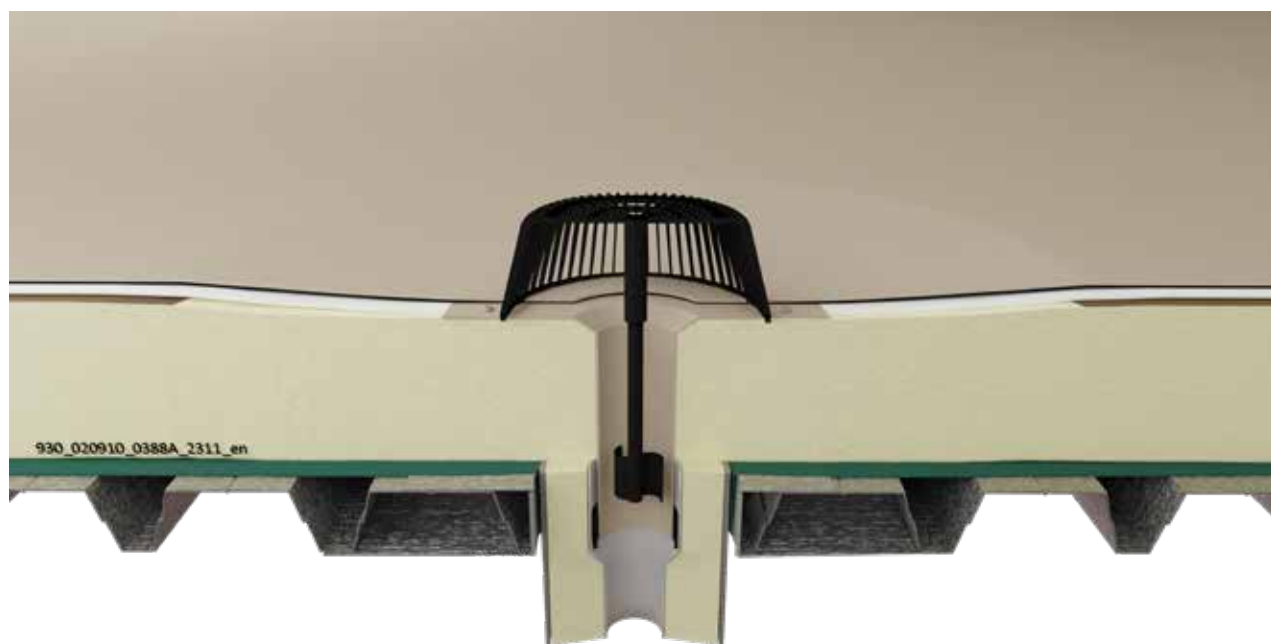

PLANNING INFORMATION

Prefabricated Sarnafil® T Drain to be mechanically fastened to surface.
Mechanically fastened, loosely laid or adhered Sarnafil® T roof waterproofing membrane hot welded to Sarnafil® T Drain.

The S-Leafguard and Gravel Frame with adjustable put on frame and perforated strainer serves as protection against infiltration of gravel and leaves into the Sarnafil® T Drain.

001.05.01 – Mechanically Fastened Roof System

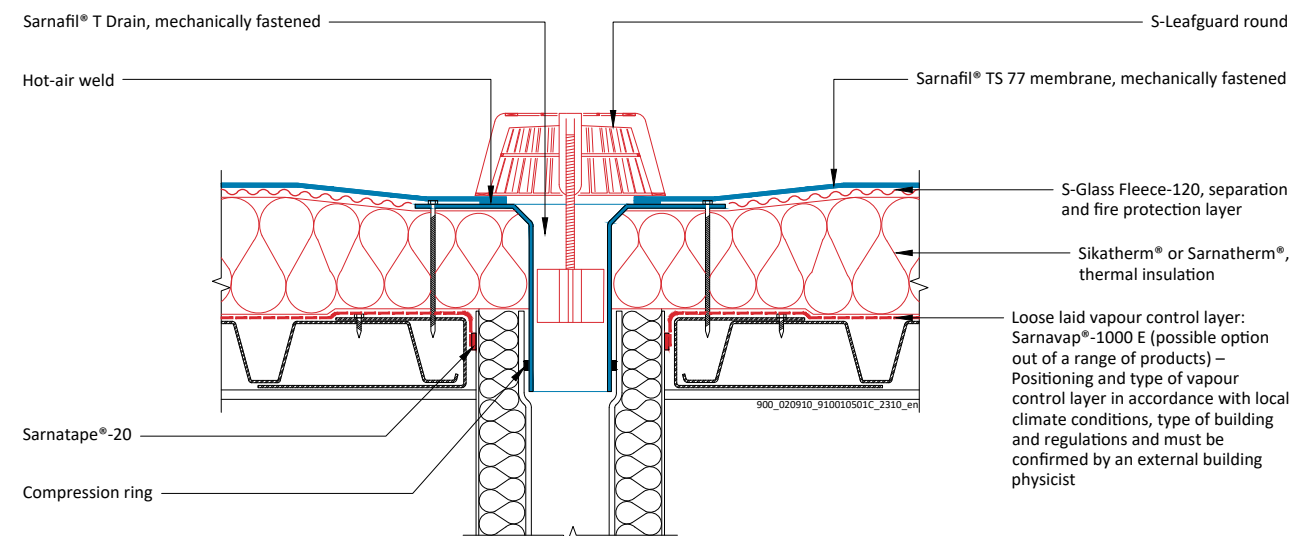

020.05.01 – Gravel Ballasted Roof System

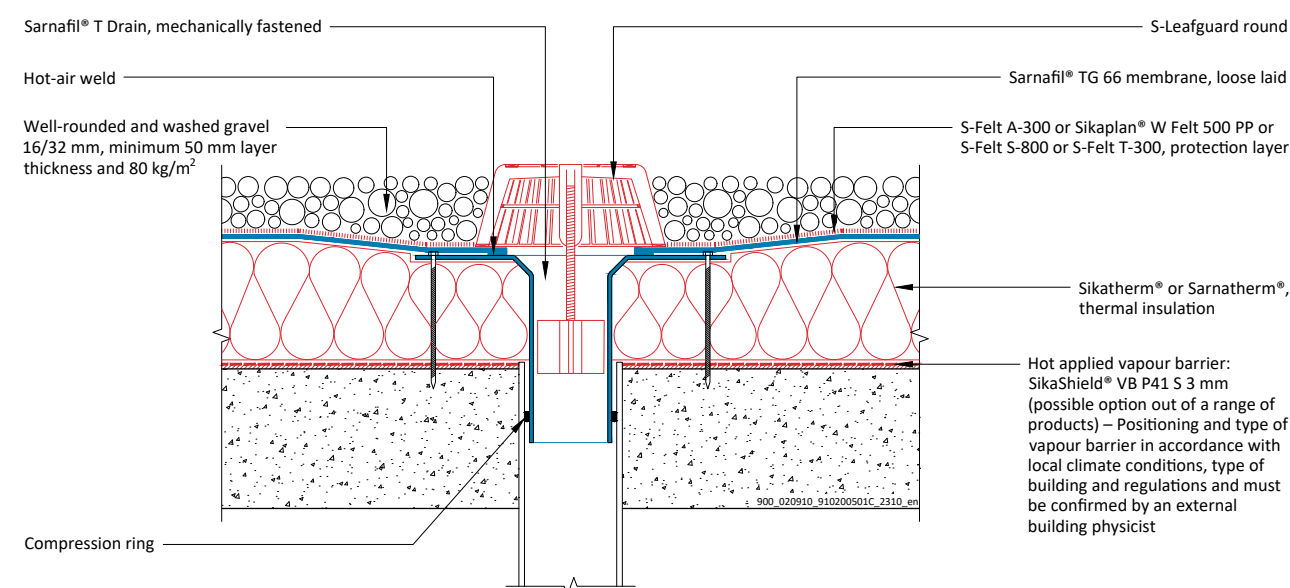

ROOF DRAIN (OUTLET)

030.05.01 – Inverted Roof System

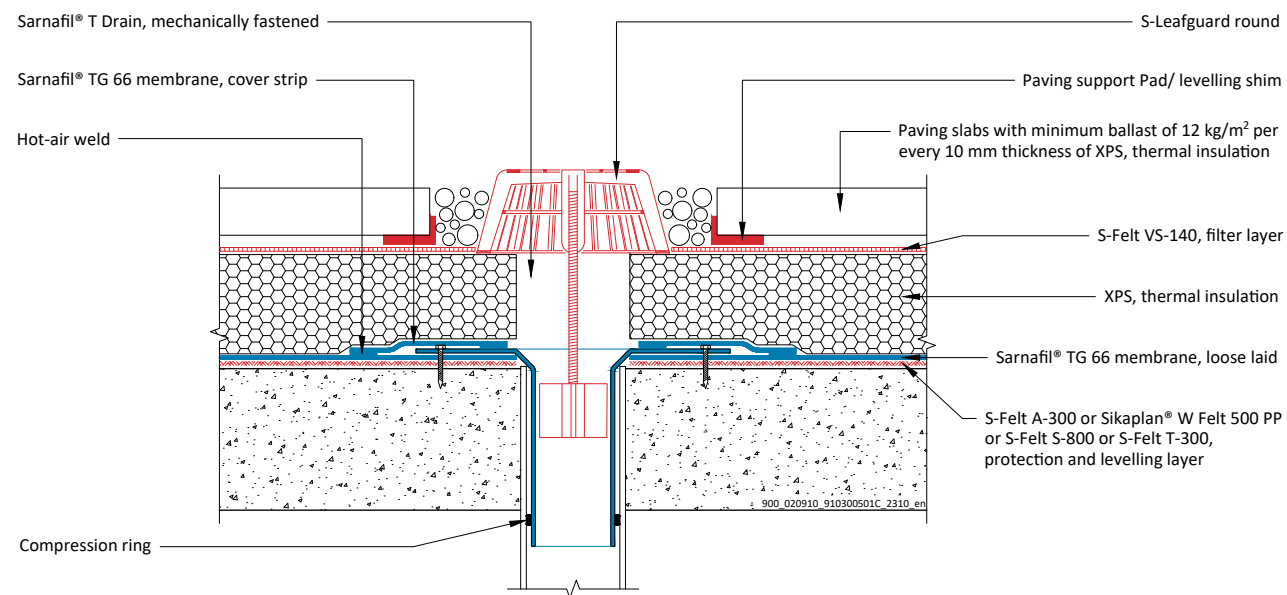

050.05.01 – Green Roof System (Extensive / Intensive)

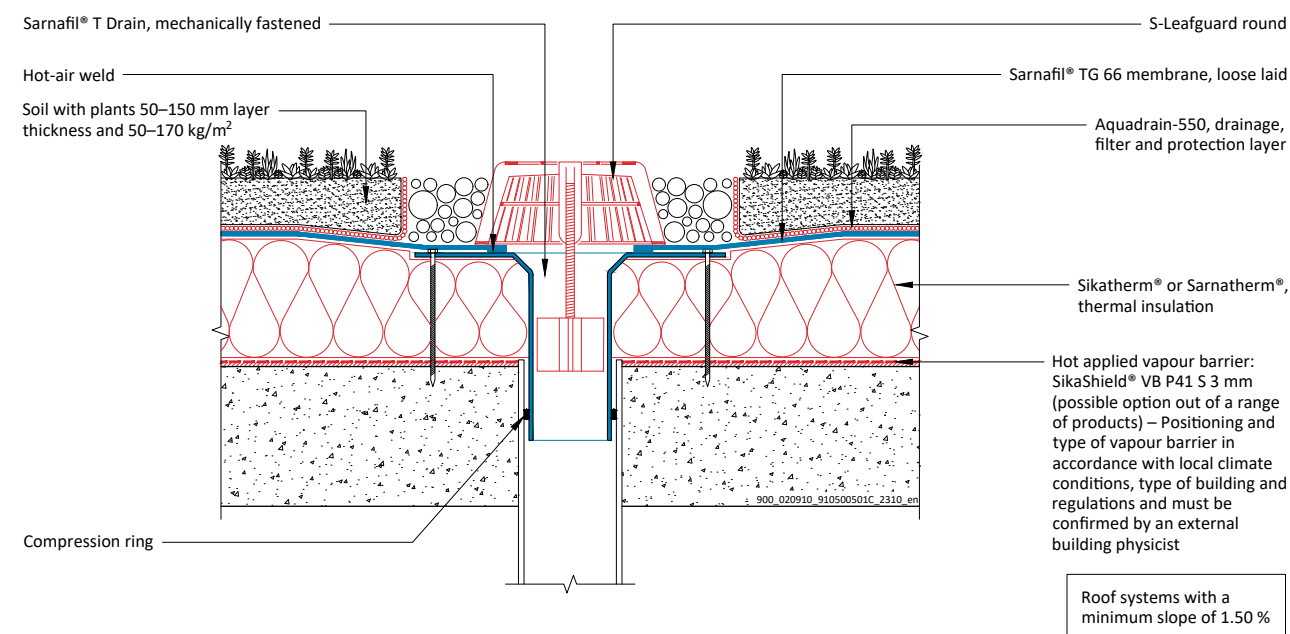

040.05.01 – Utility Roof System

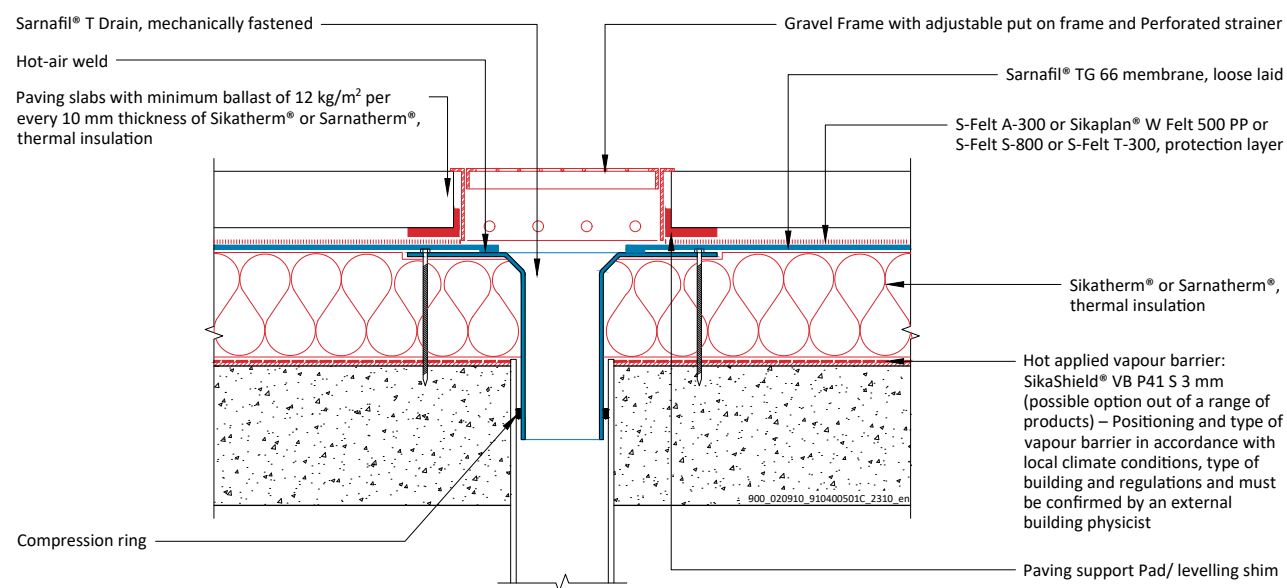

060.05.01 – Adhered Roof System

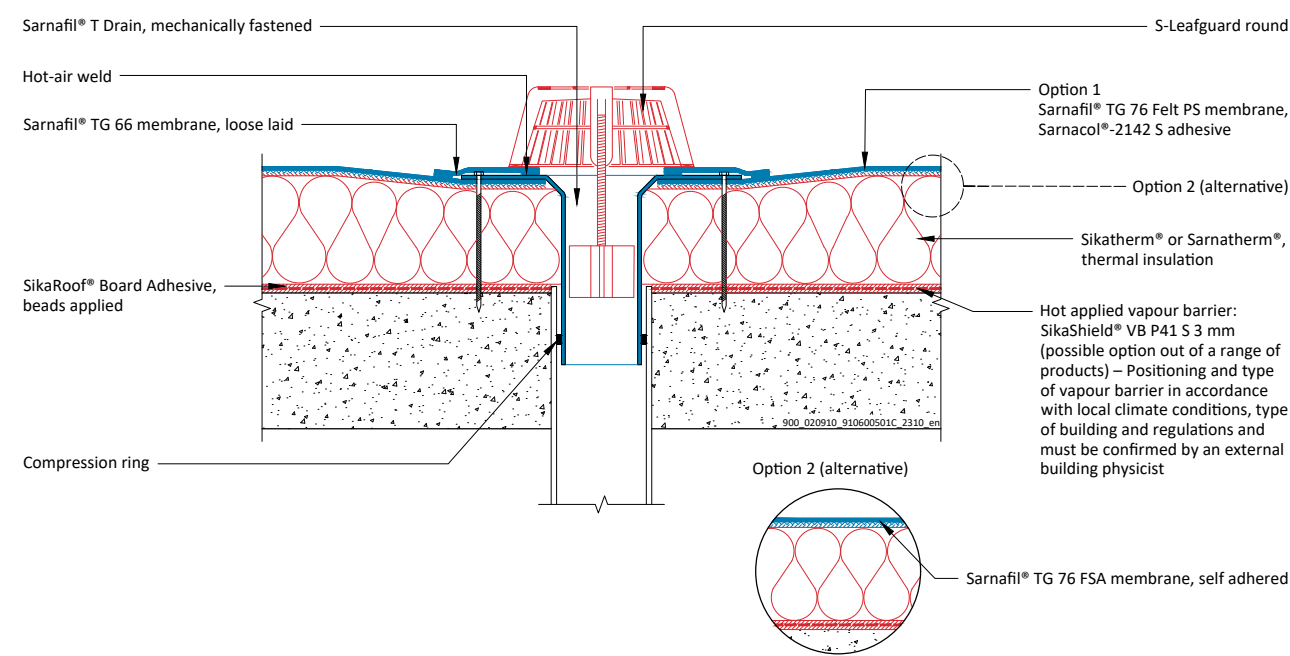

STANDARD DETAILS

SCUPPER

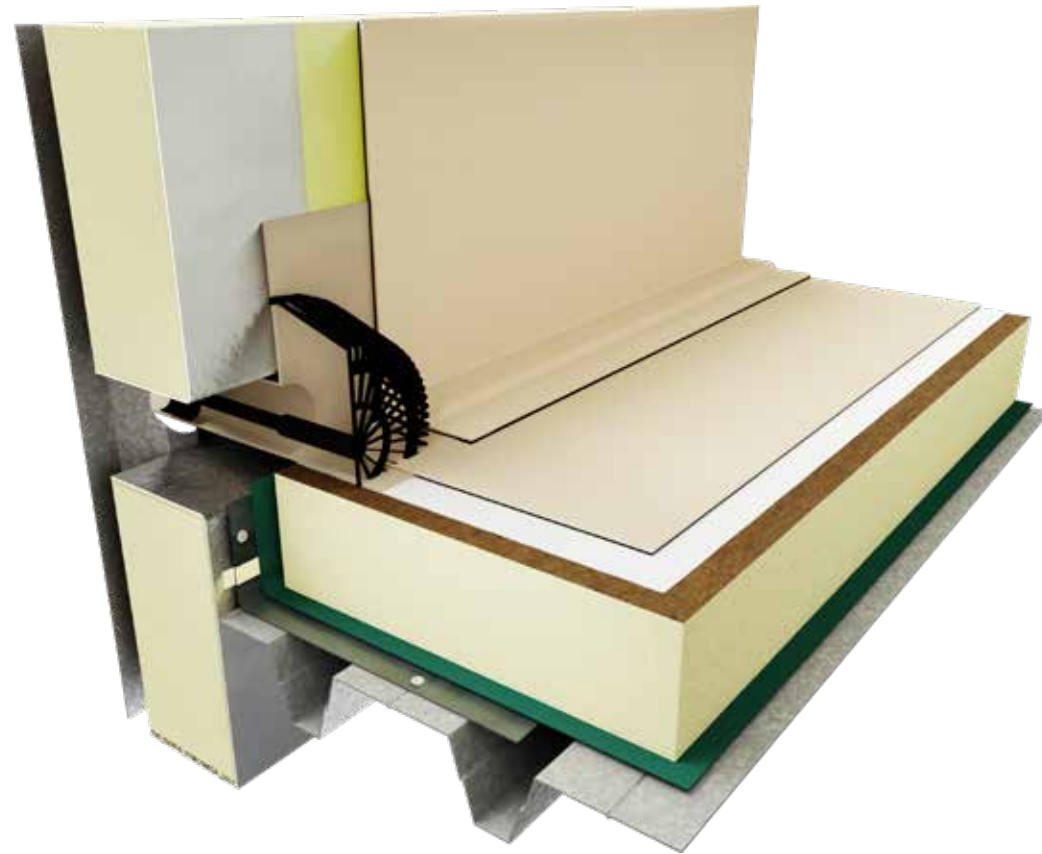

PLANNING INFORMATION

Prefabricated Sarnafil® T Scupper to be mechanically fastened to surface. Mechanically fastened, loosely laid or adhered Sarnafil® T roof waterproofing membrane and Sarnafil® T upstand membrane hot welded to Sarnafil® T Scupper.

A counter flashing should be installed on utility roof systems to protect the membrane.

The S-Leafguard and Gravel Frame with adjustable put on frame and perforated strainer serves as protection against infiltration of gravel and leaves into the Sarnafil® T Scupper.

001.06.02 – Adhered on Metal Wall Element – Mechanically Fastened Roof System

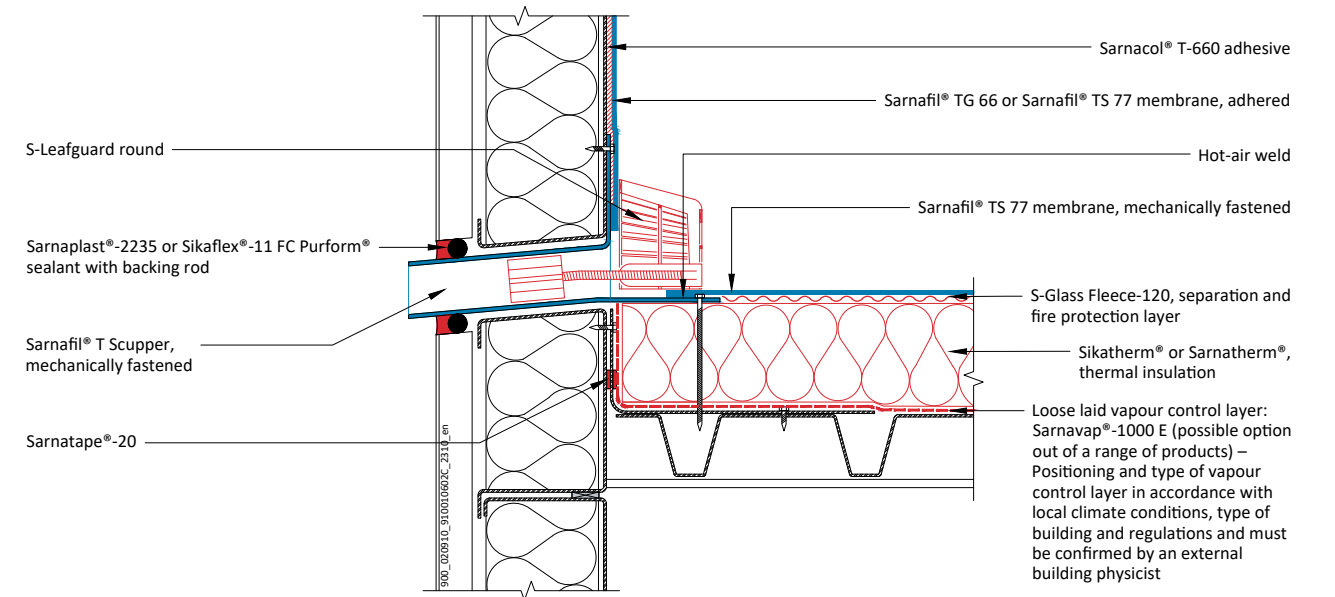

020.06.02 – Adhered on Concrete Wall – Gravel Ballasted Roof System

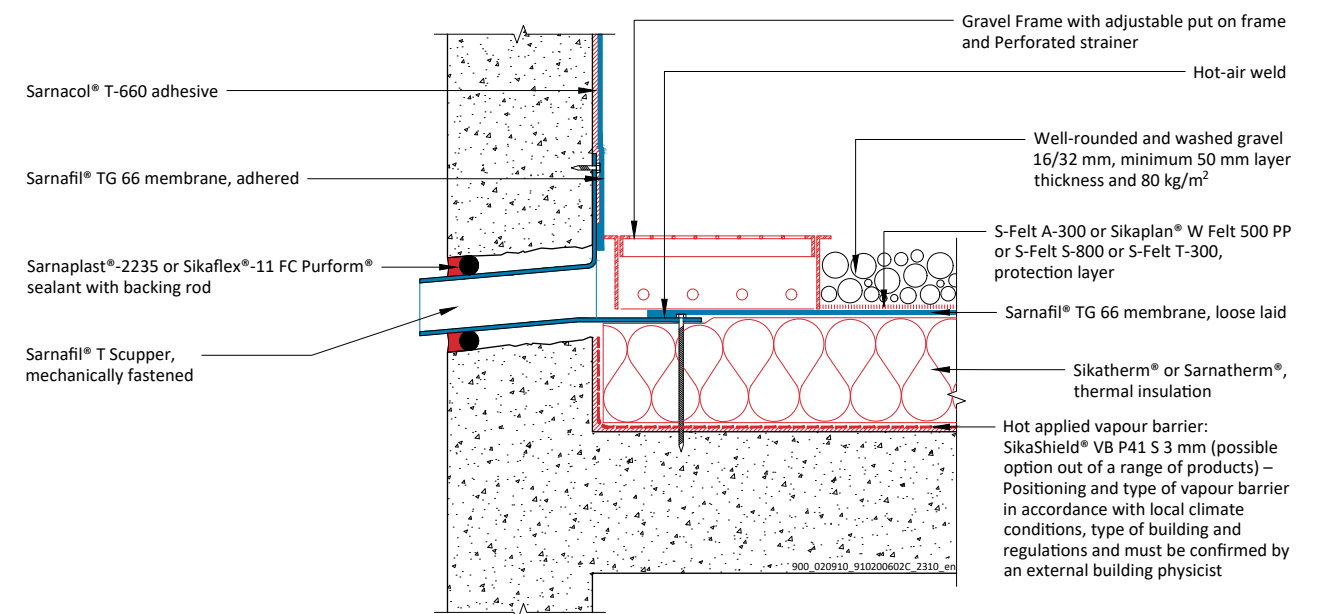

STANDARD DETAILS

SCUPPER

030.06.02 – Adhered on Concrete Wall – Inverted Roof System

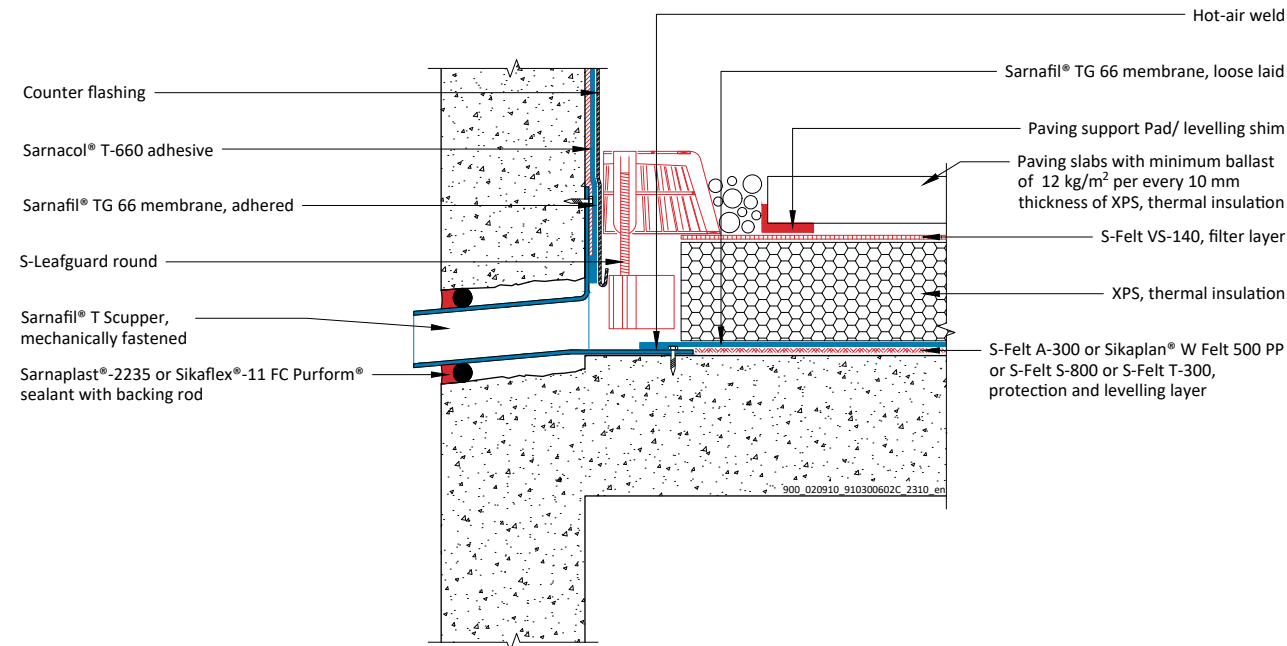

050.06.02 – Adhered on Concrete Wall – Green Roof System (Extensive / Intensive)

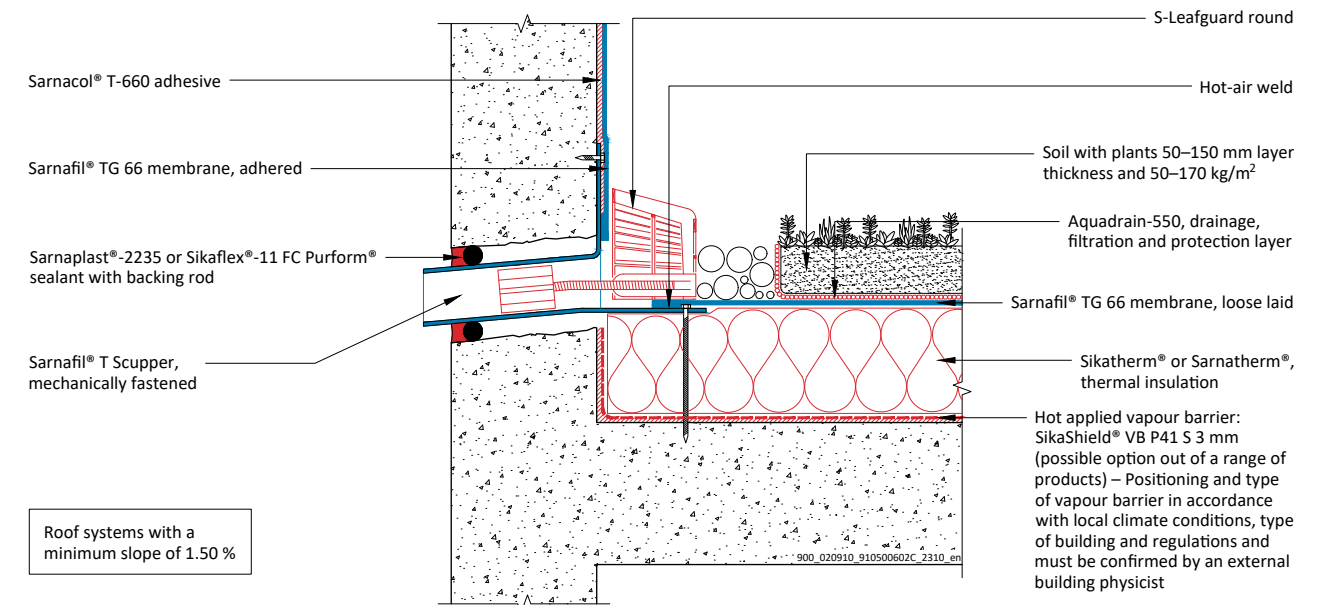

040.06.02 – Adhered on Concrete Wall – Utility Roof System

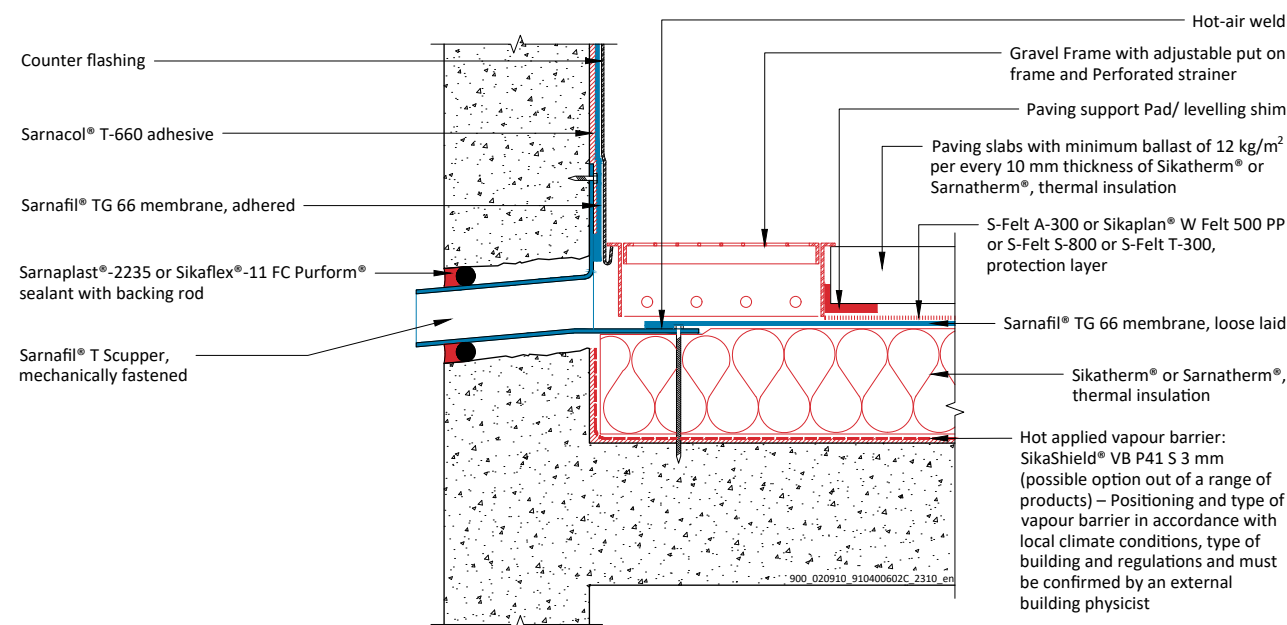

060.06.01 – Adhered on Concrete Wall – Adhered Roof System

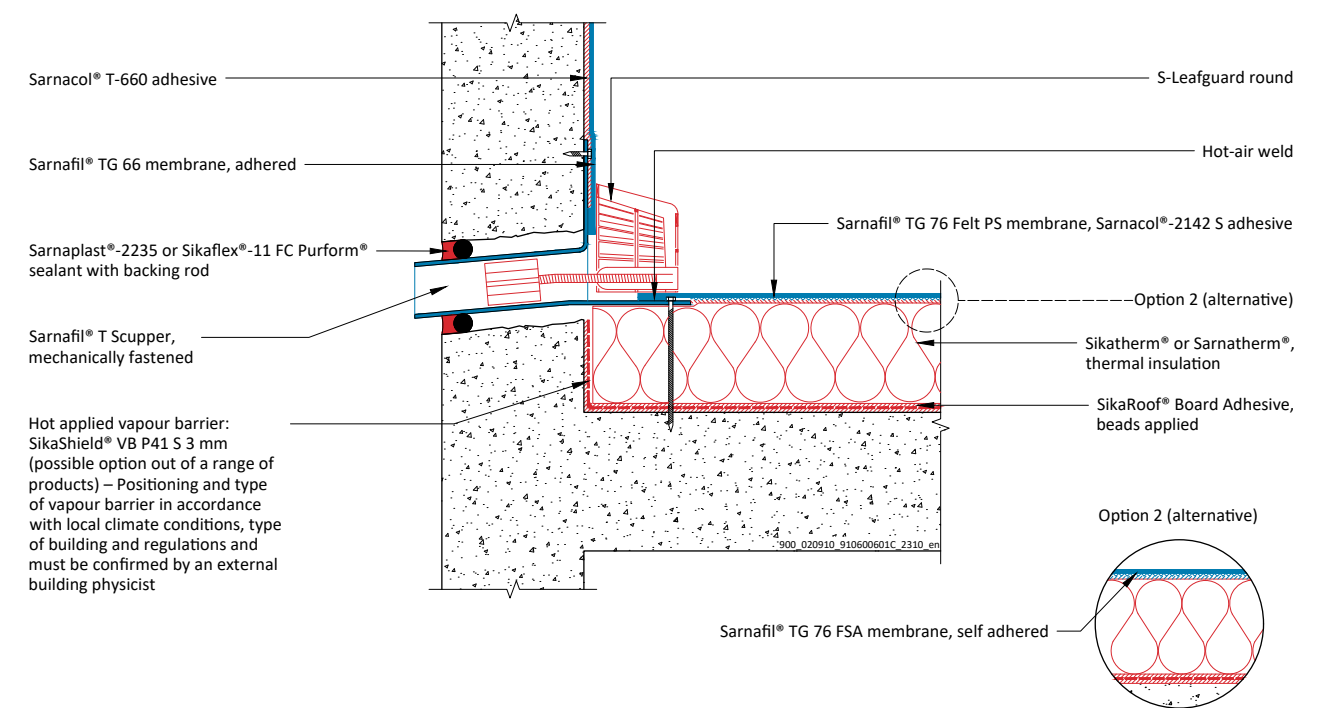

STANDARD DETAILS

OVERFLOW

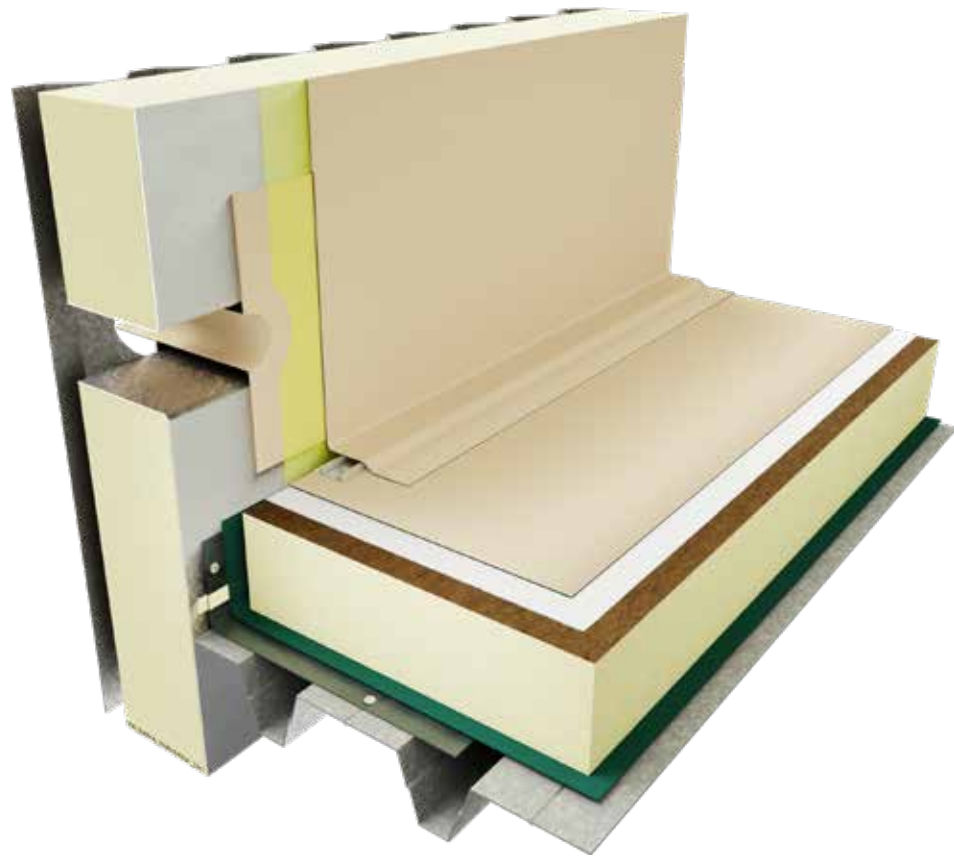

PLANNING INFORMATION

Prefabricated Sarnafil® T Overflow to be mechanically fastened to upstand structure. Sarnafil® T upstand membrane hot welded to Sarnafil® T Overflow.

A counter flashing should be installed on utility roof systems to protect the membrane.

001.07.02 – Adhered on Metal Wall Element – Mechanically Fastened Roof System

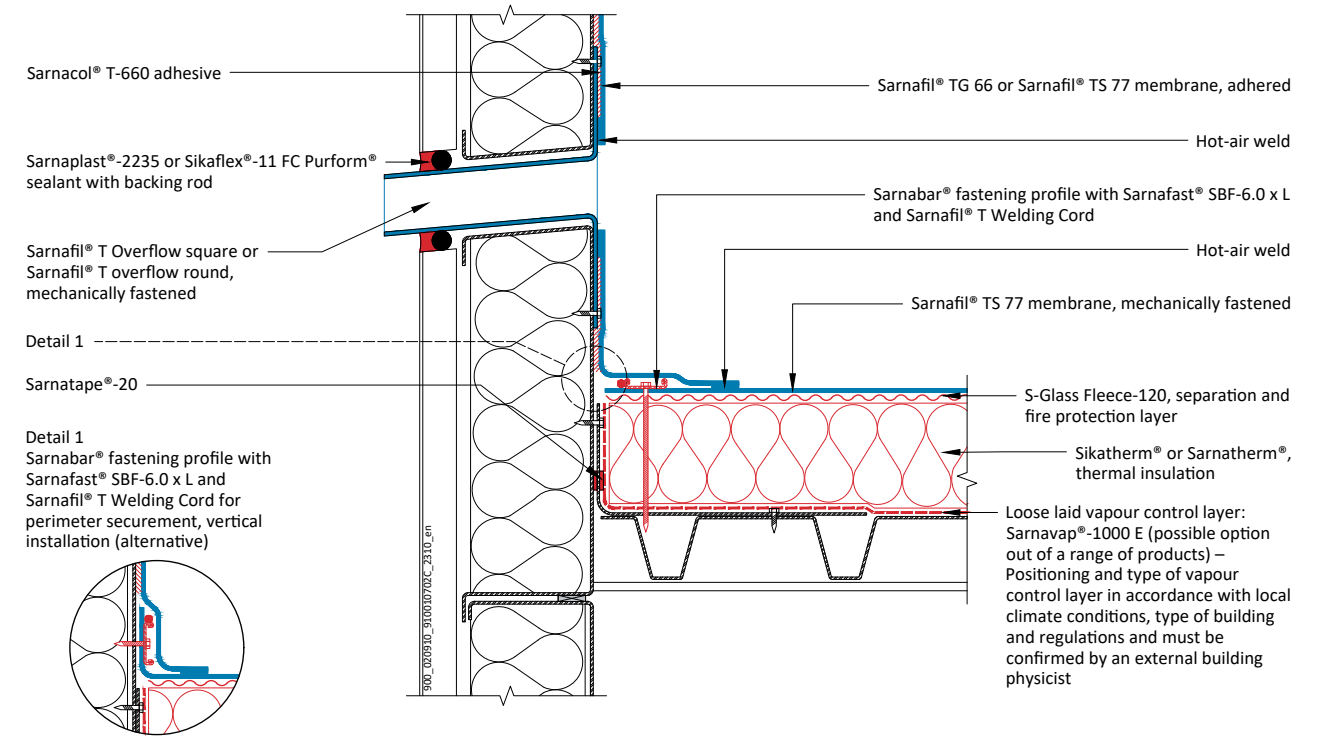

020.07.02 – Adhered on Concrete Wall – Gravel Ballasted Roof System

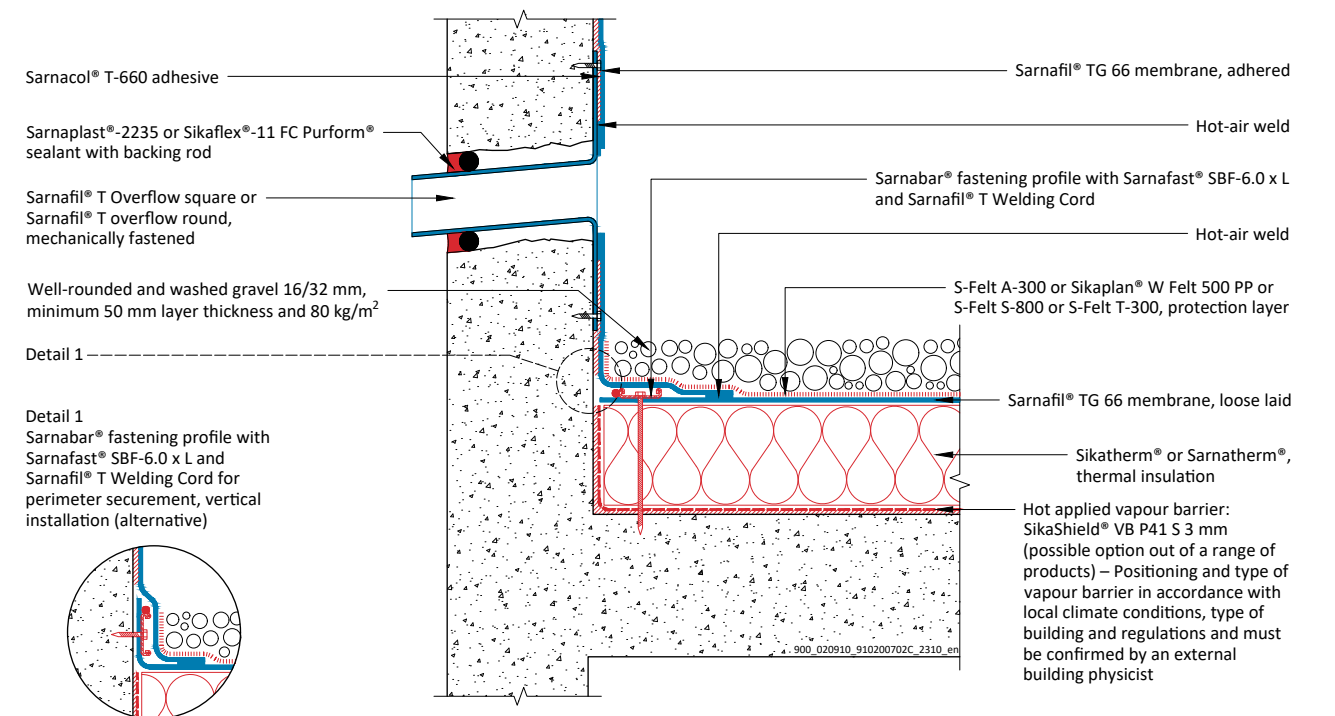

VENT PIPE / POST



PLANNING INFORMATION

On vent pipe / post flashing Sarnafil® TS roof waterproofing for mechanically fastened roof systems to be point fastened using four Sarnafast® Washers and Fasteners. In all other ballasted / adhered roof systems, no additional fastening to be needed.

Sarnafil® T Pipe / Post Flashing to be hot welded to Sarnafil® T roof waterproofing membrane.

Top end of Sarnafil® T Pipe / Post Flashing to be waterproofed using shrinking hose or stainless steel jubilee clip in combination with Sarnaplast®-2235 or Sikaflex®-11 FC Purform® sealant.

A counter flashing should be installed on utility roof systems to protect the membrane.

001.08.01 – Mechanically Fastened Roof System

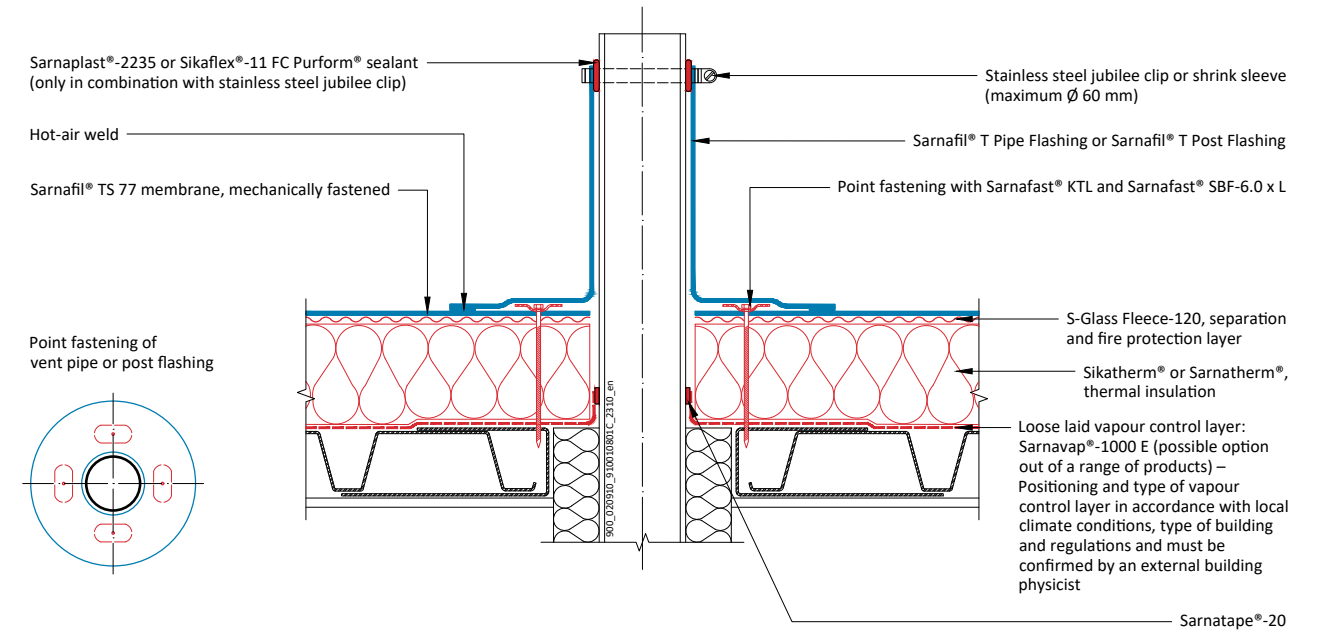

020.08.01 – Gravel Ballasted Roof System

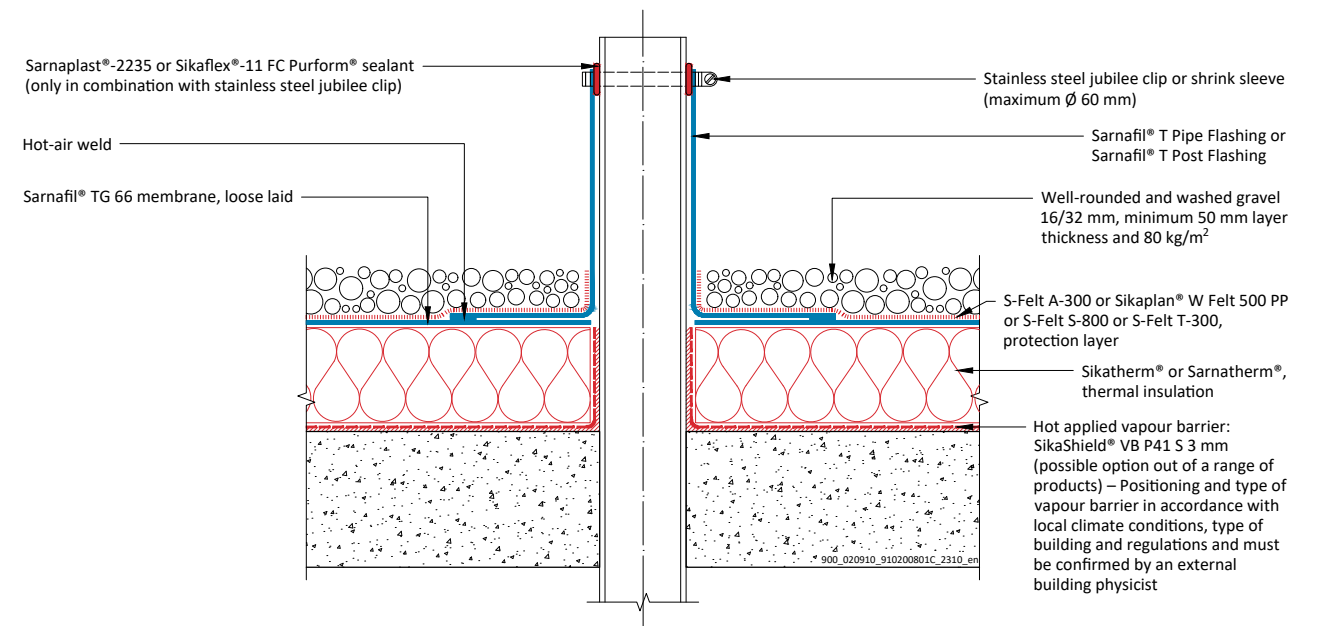

VENT PIPE / POST

030.08.01 – Inverted Roof System

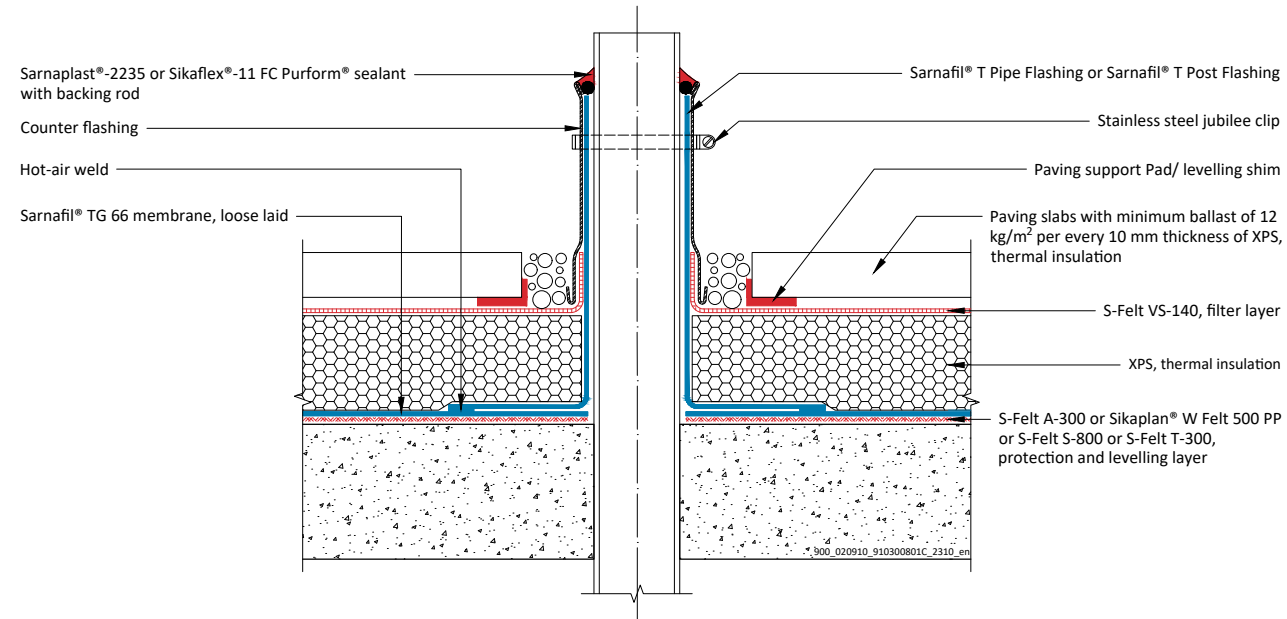

050.08.01 – Green Roof System (Extensive / Intensive)

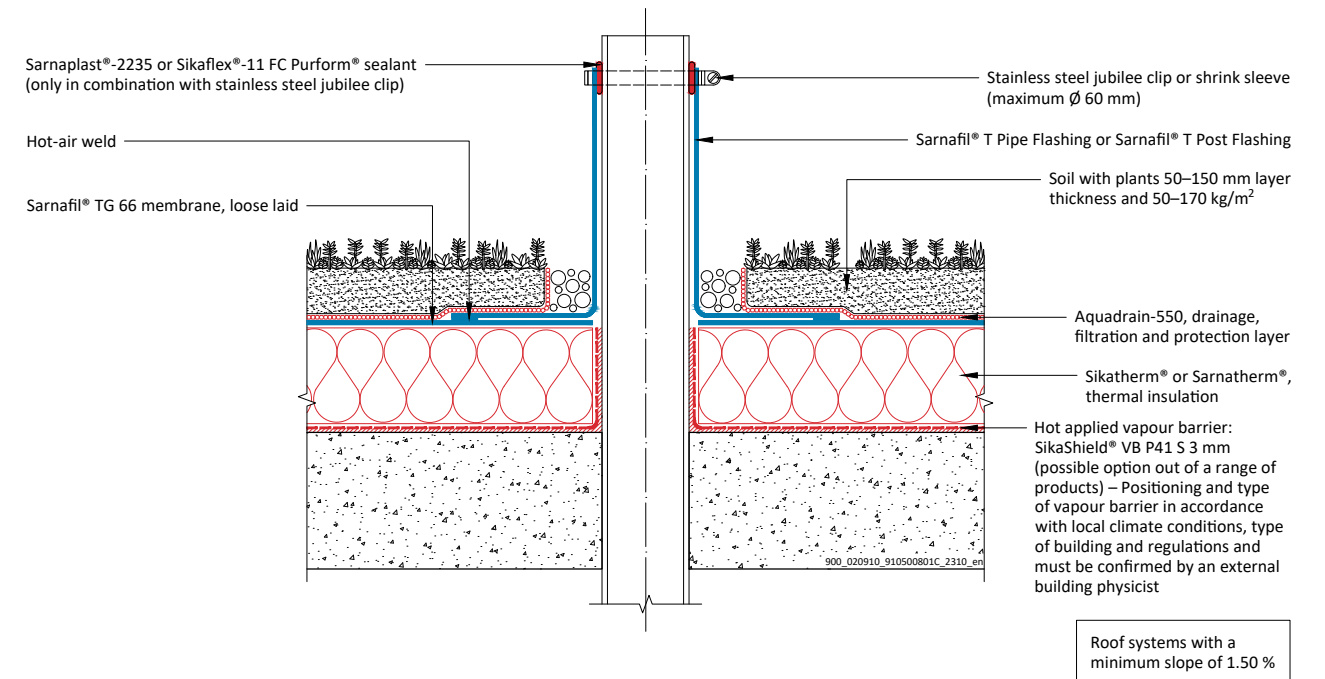

040.08.01 – Utility Roof System

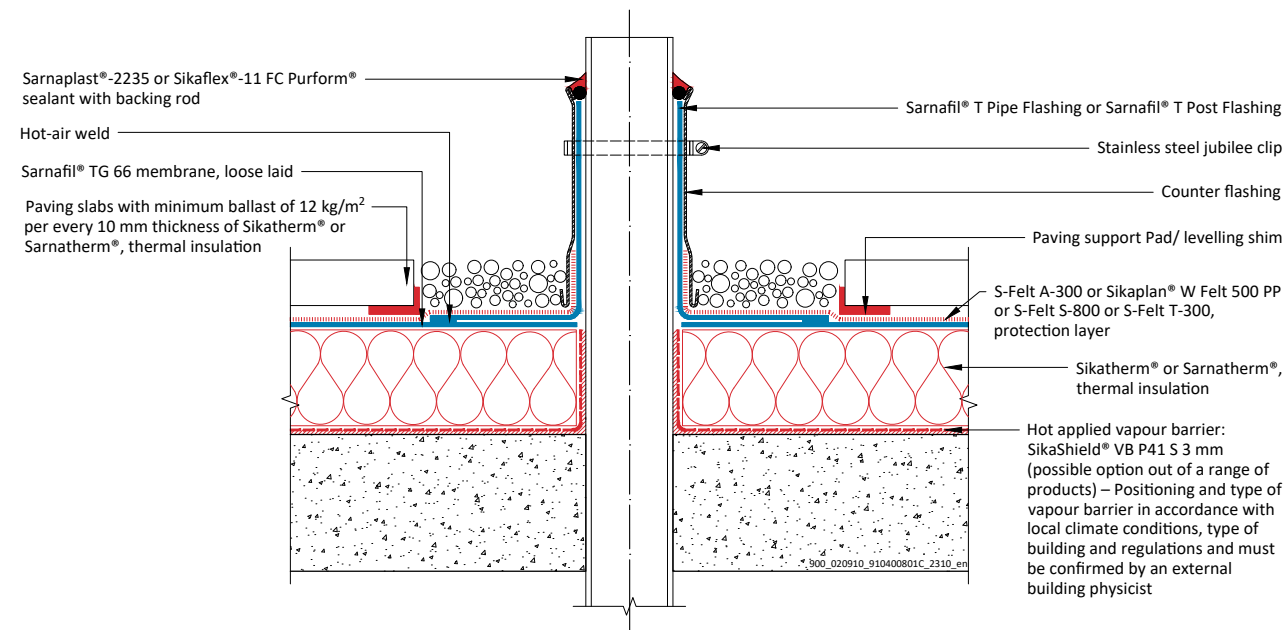

060.08.01 – Adhered Roof System

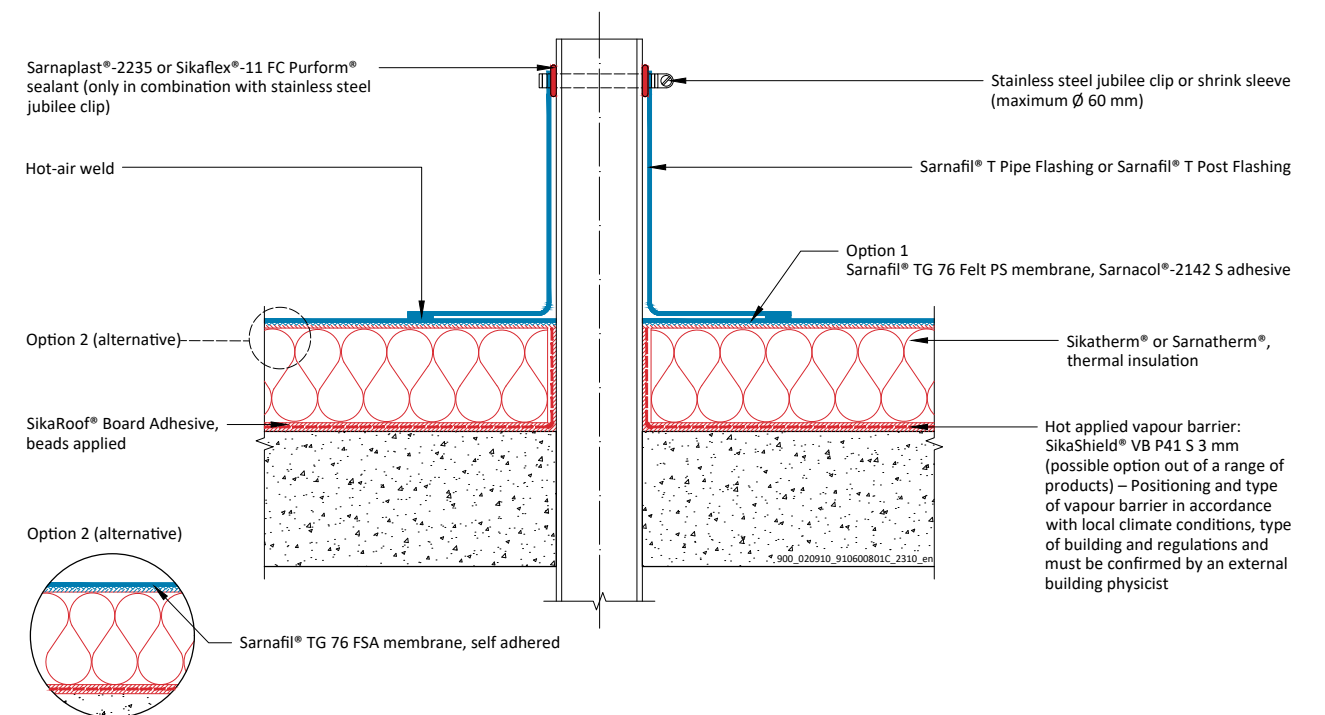

STANDARD DETAILS

GUTTER



PLANNING INFORMATION

Gutter edges on top of thermal insulation should be protected with metal flashing.

Sarnafil® T roof waterproofing membrane must be secured with either Sarnabar® or Sarnafast® washers and fasteners.

Mechanically fastened gutter flashing, using Sarnafil® TS membrane and Sarnabar® fastening profile with Sarnafast® fasteners securement along vertical areas.

Adhered gutter flashing, using Sarnacol® T-660 adhesive and Sarnafil® TG 66 membrane along vertical areas. Depending on the width of gutter Sarnafil TG 76 membrane secured with Sarnabar® fastening profile and Sarnafast® fasteners along vertical areas.

001.09.01 – Mechanically Fastened Roof System

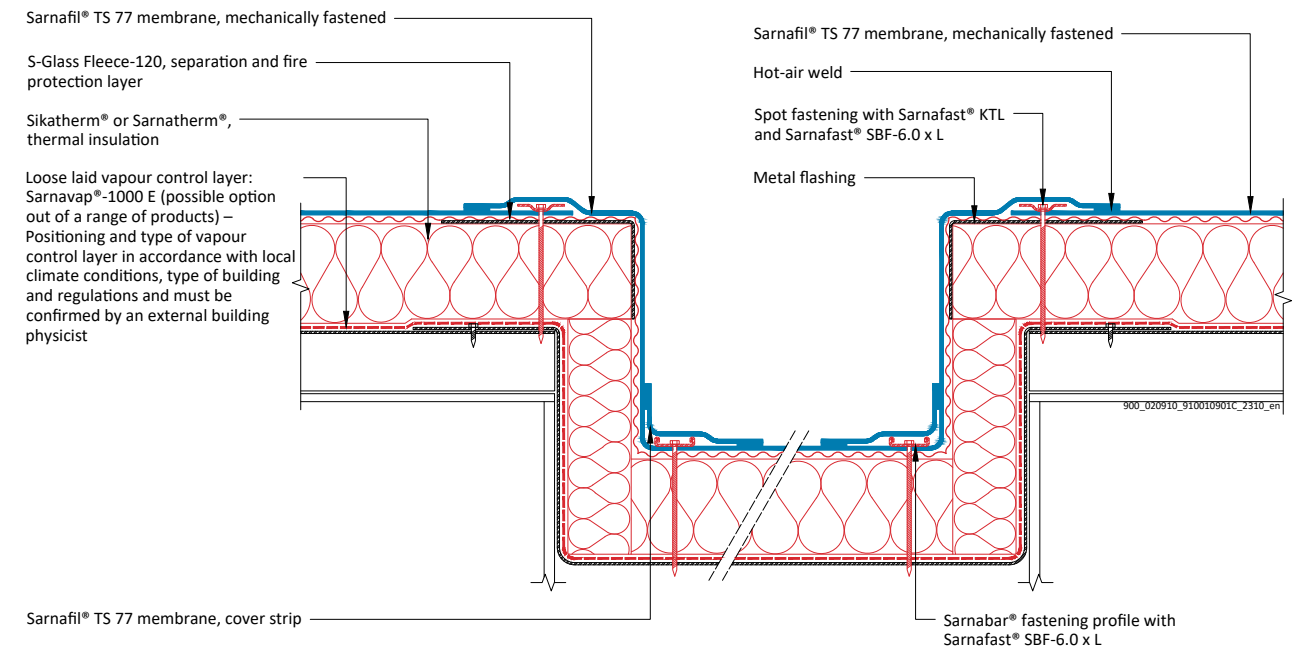

060.09.01 – Adhered Roof System

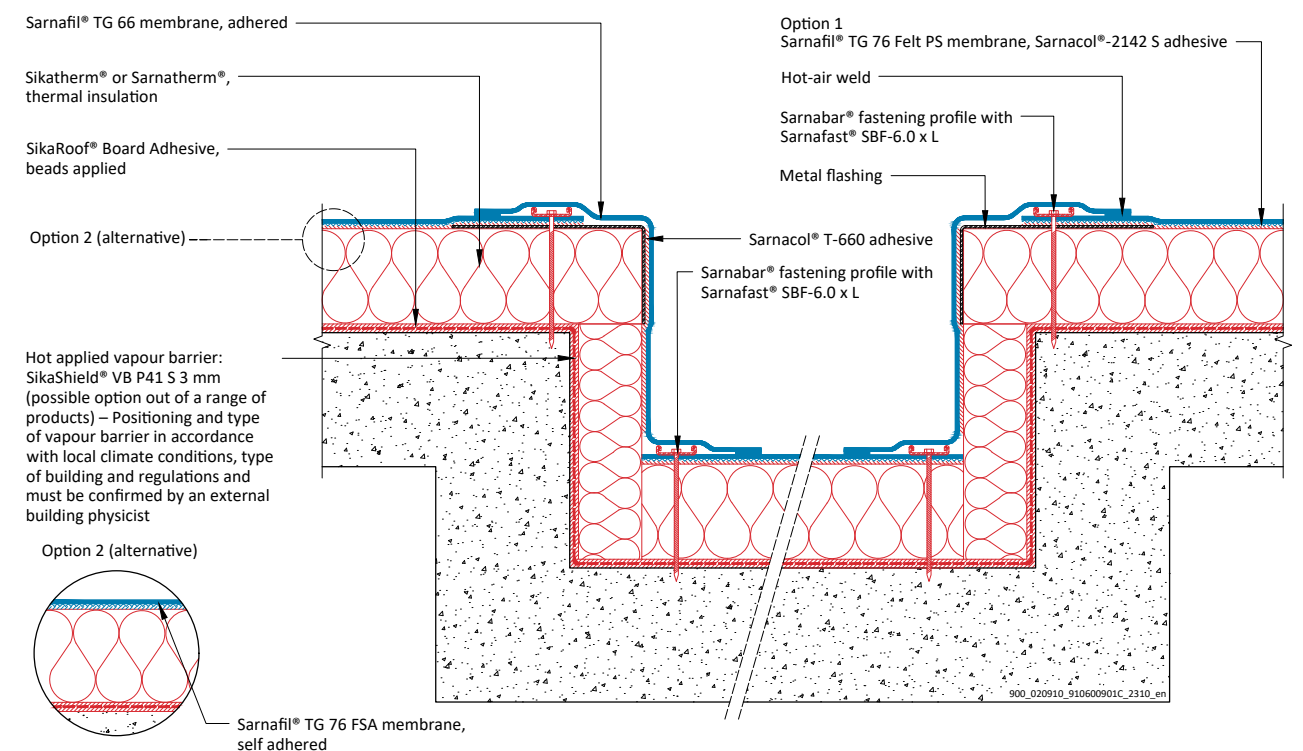

MOVEMENT JOINT



PLANNING INFORMATION

Vapour- control layer / barrier to be installed with an expansion loop above metal flashing.

Sarnafil® T membrane must be secured with Sarnabar® fastening profile and Sarnafast® fasteners on both sides of movement joints.

Sarnafil® T Gravel stop bracket and S-Gravelstop Profile to be installed in combination with ballasted roof systems.

Installation of expanded polyethylene rod and waterproof with Sarnafil® T cover-strip, hot welded on both sides of movement joints to Sarnafil® T roof waterproofing membrane.

001.10.01 – Mechanically Fastened Roof System

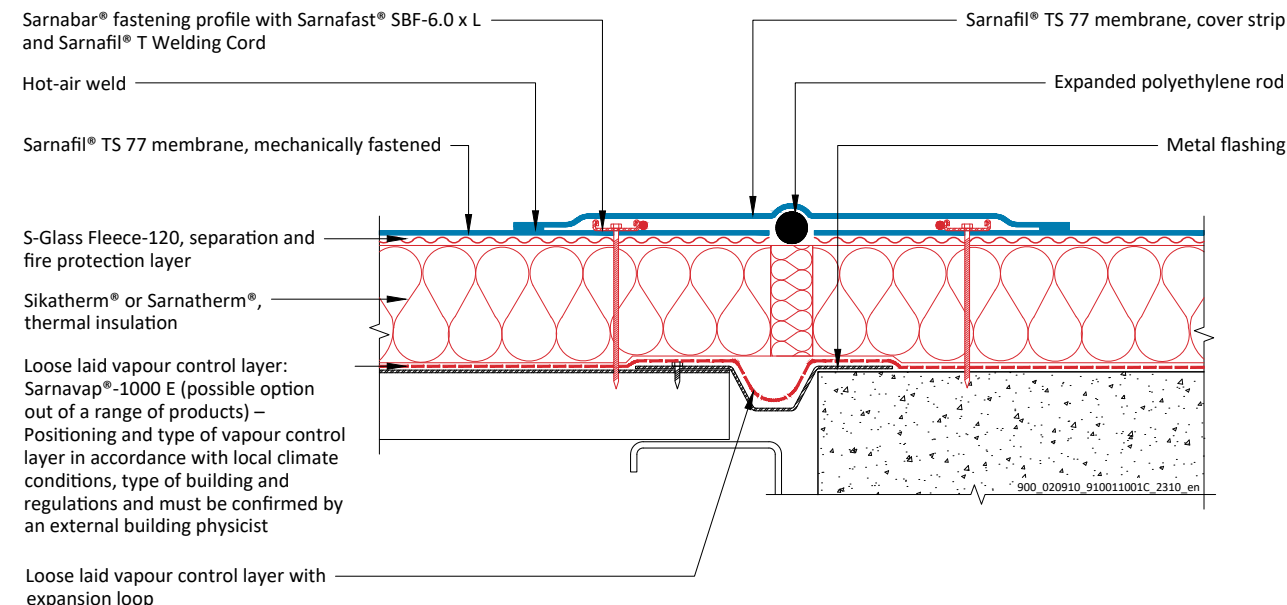

020.10.01 – Gravel Ballasted Roof System

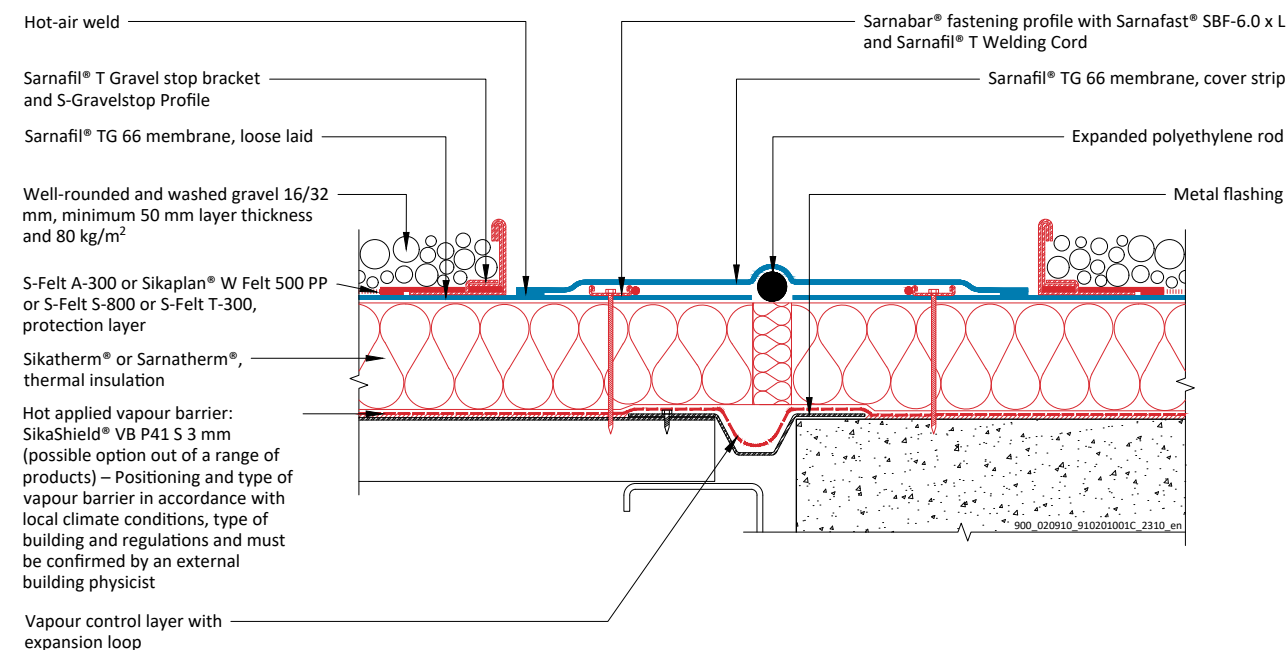

MOVEMENT JOINT

030.10.01 - Inverted Roof System

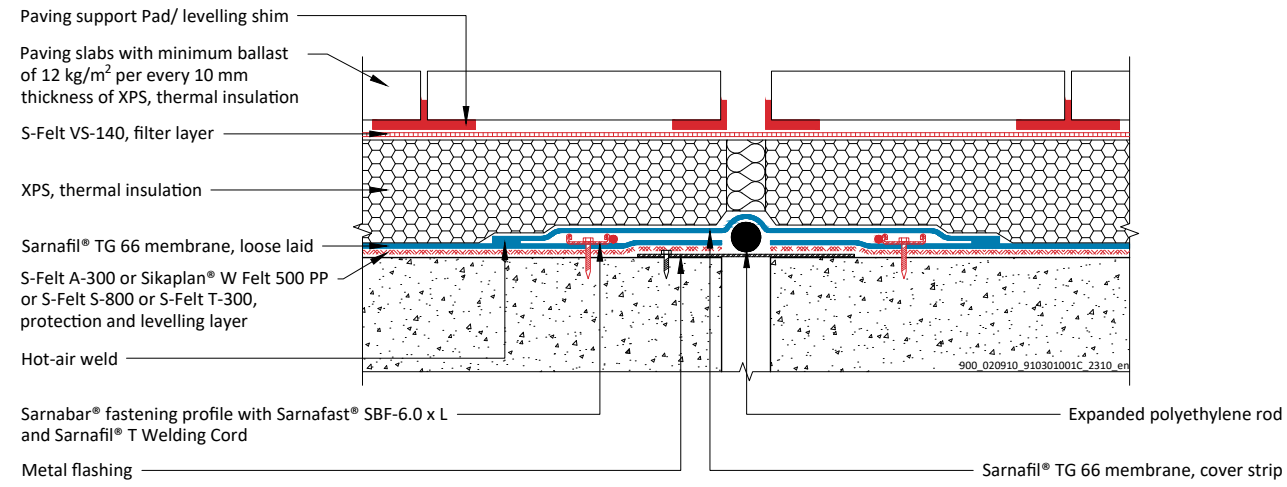

060.10.01 - Adhered Roof System

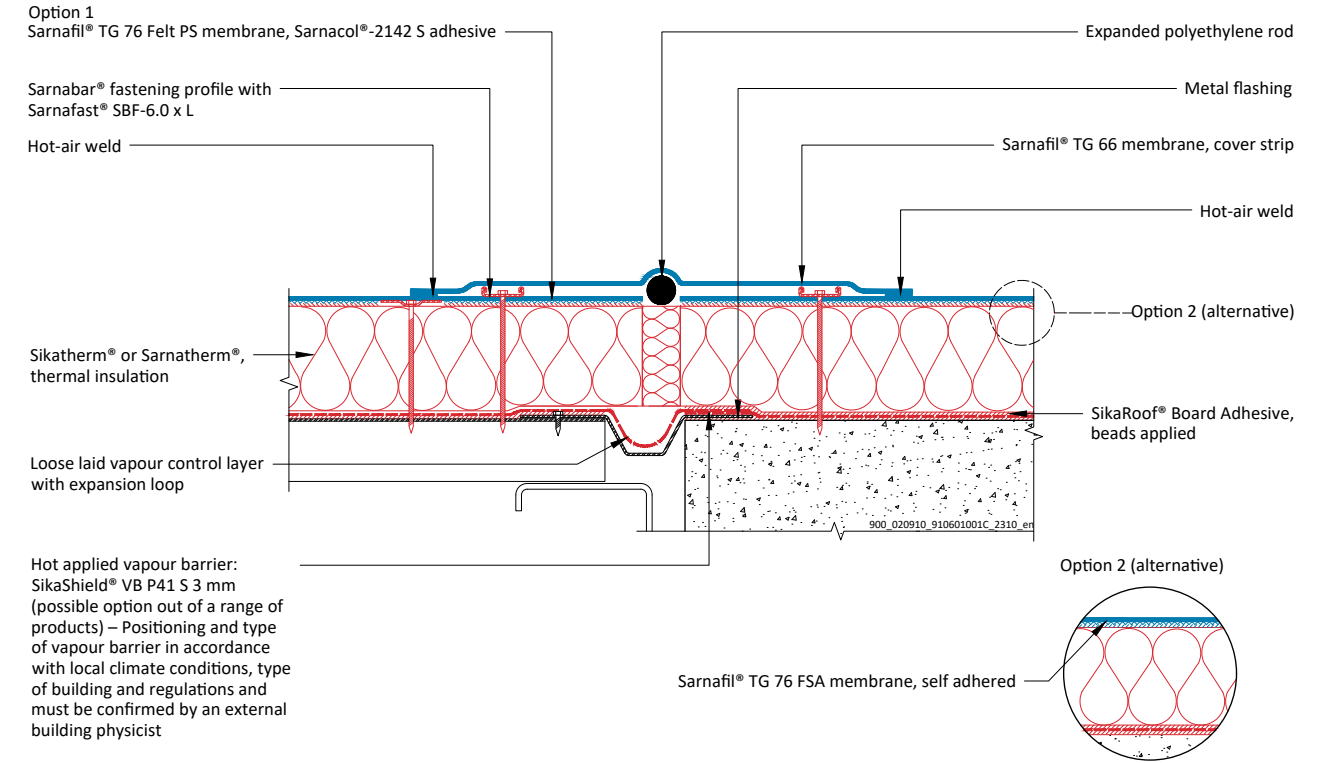

PENETRATION - DOUBLE T STEEL BEAM

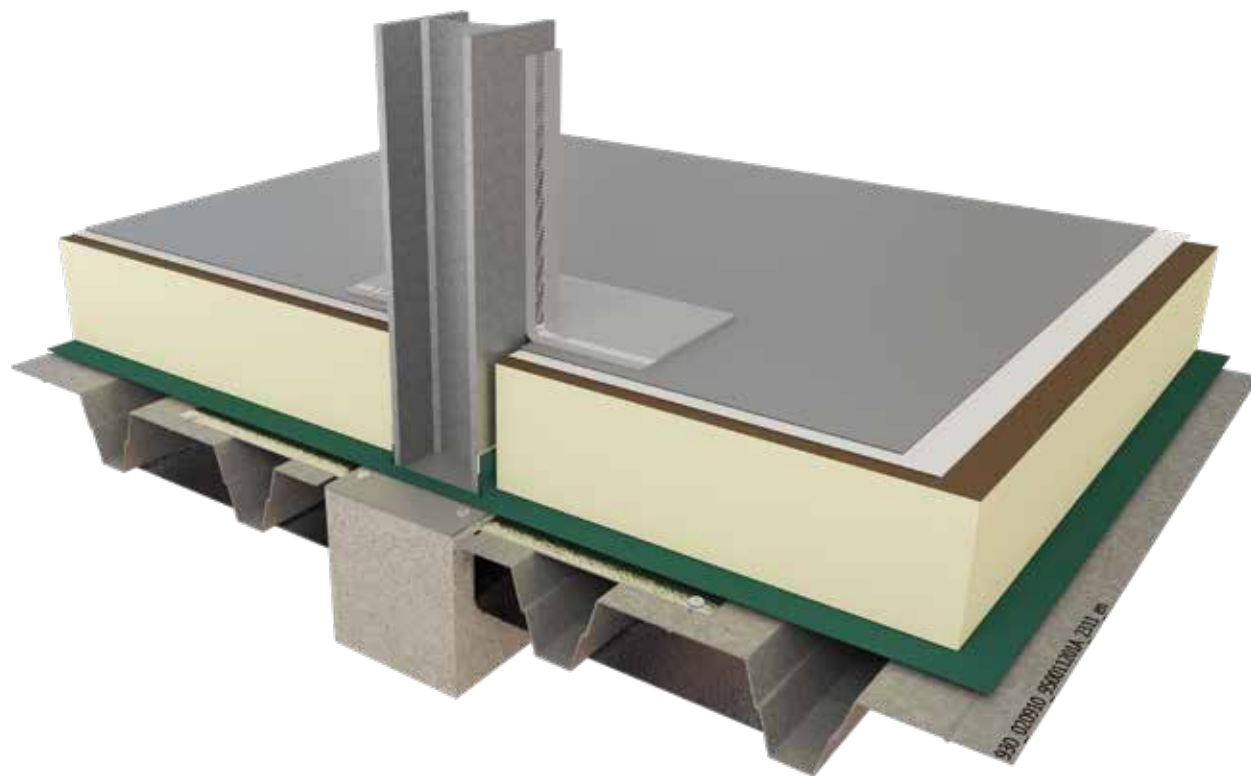

PLANNING INFORMATION

Detailing utilizing Sikalastic®-625 N first layer (base coat) in combination with Sika® Reemat Premium embedded and Sikalastic®-625 N second layer (top coat) for the application to Sarnafil® T roof waterproofing membrane is an exceptionally efficient method of protecting difficult details.

001.12.01 - Mechanically Fastened Roof System

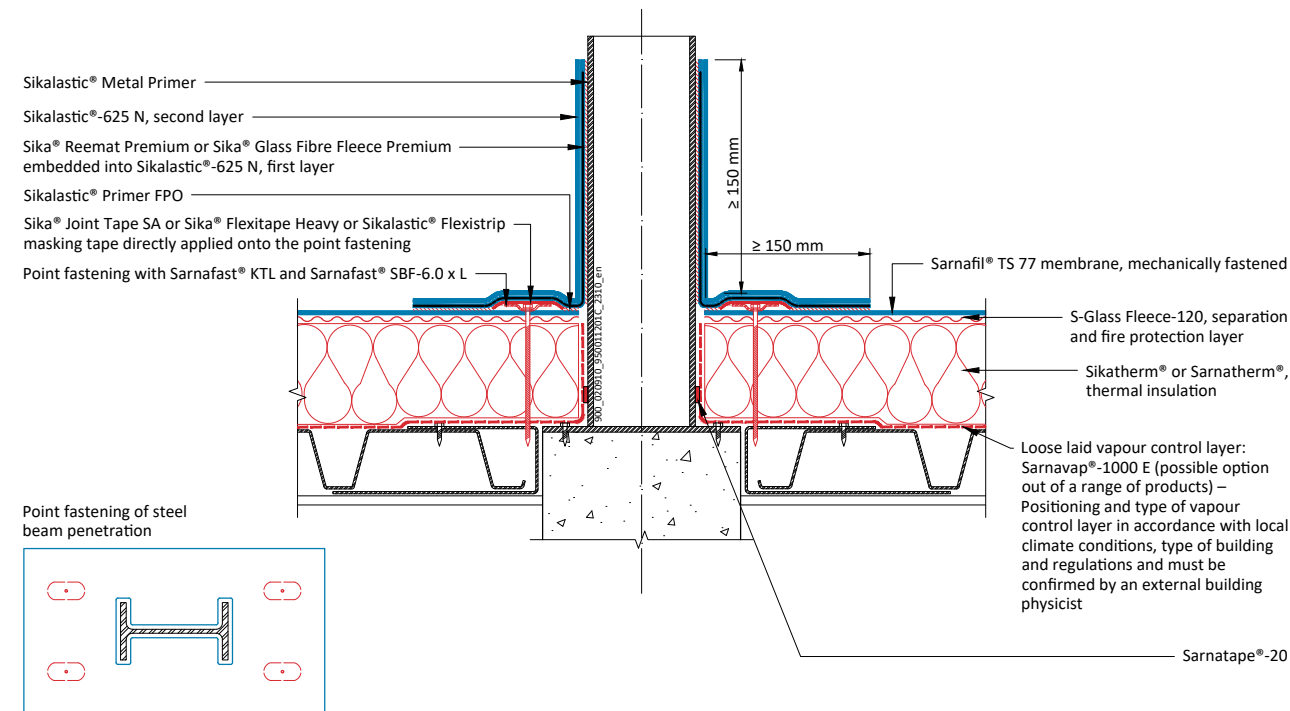

020.12.01 - Gravel Ballasted Roof System

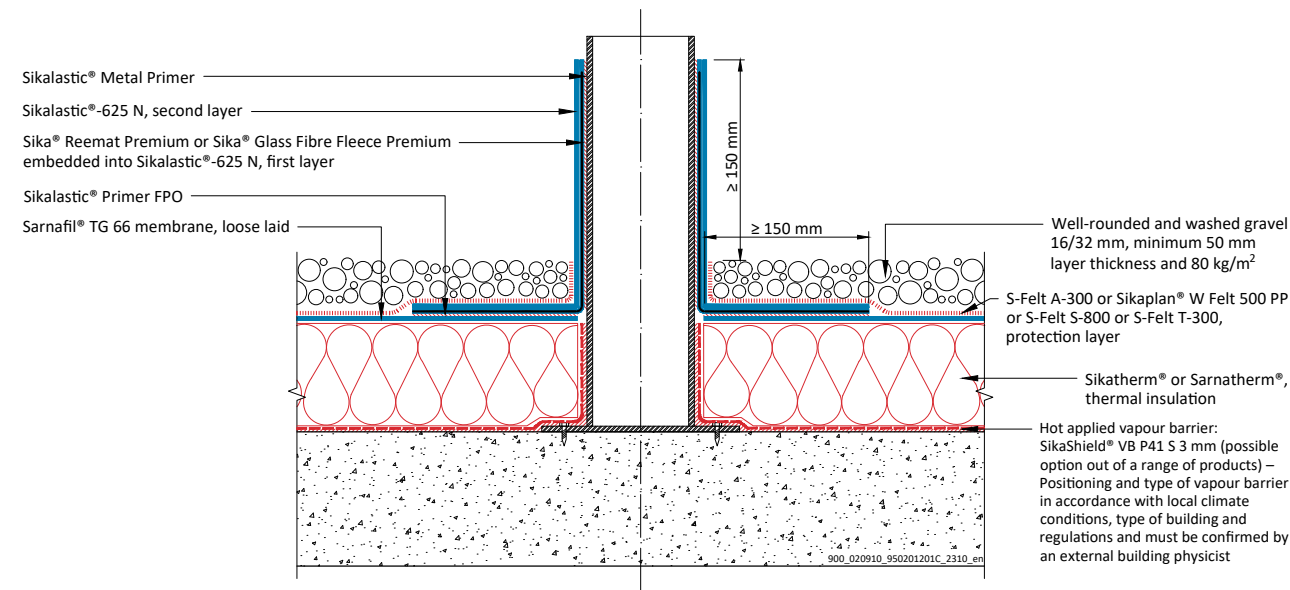

PENETRATION - DOUBLE T STEEL BEAM

030.12.01 - Inverted Roof System

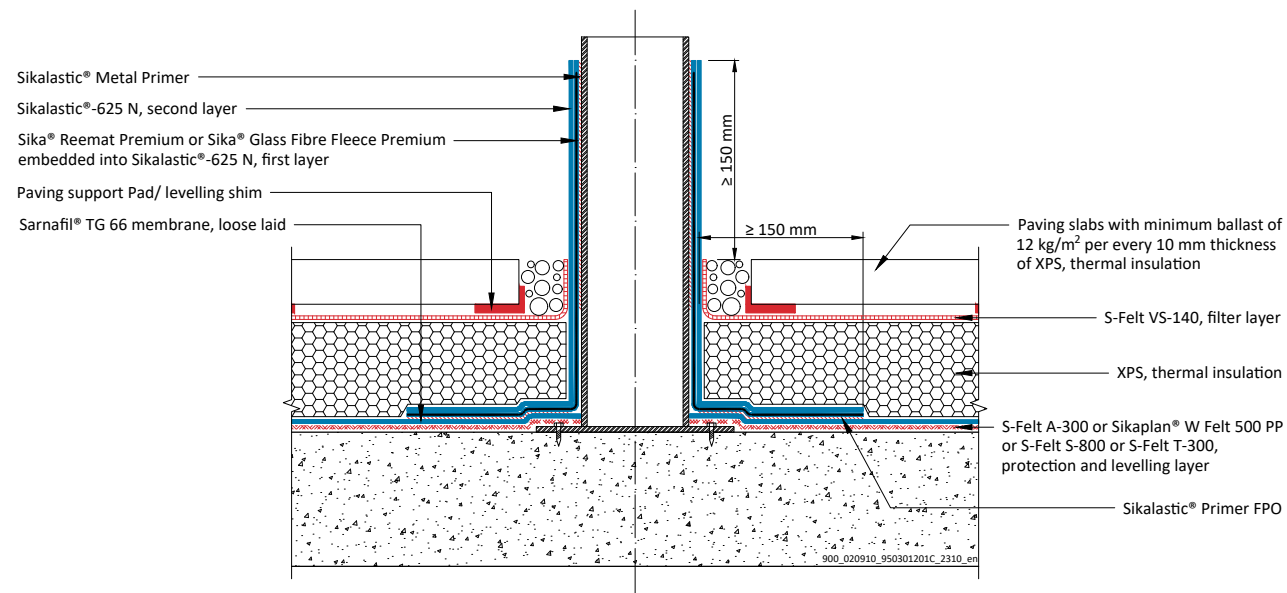

050.12.01 - Green Roof System (Extensive / Intensive)

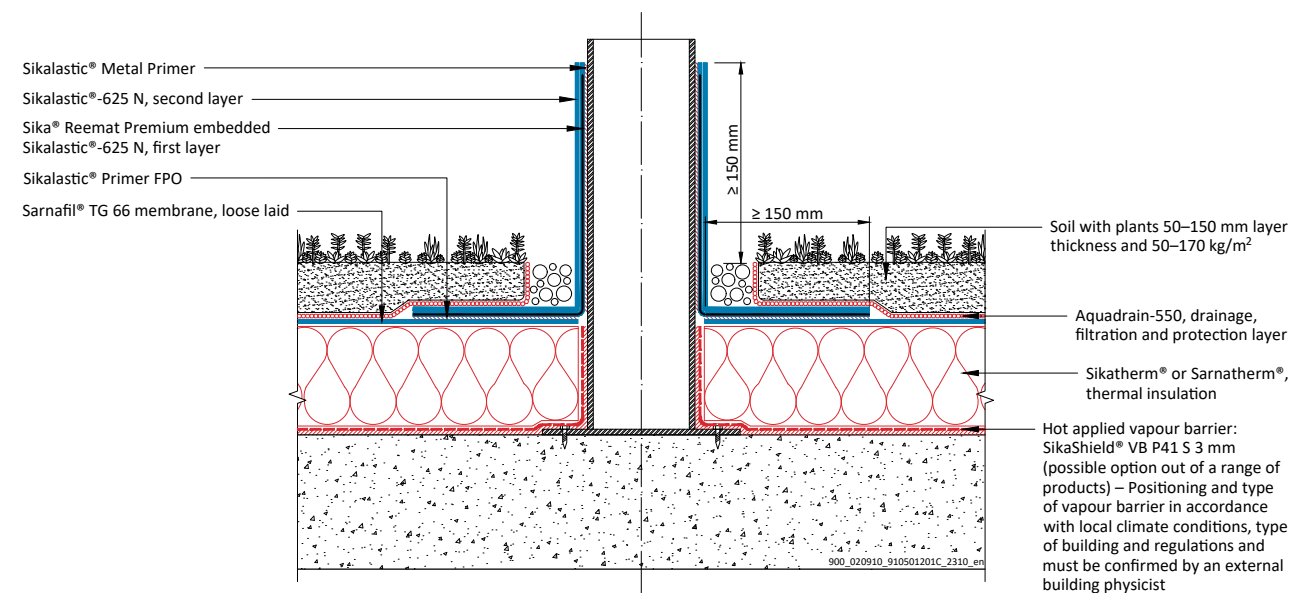

Roof systems with a minimum slope of 1.50 %

040.12.01 - Utility Roof System

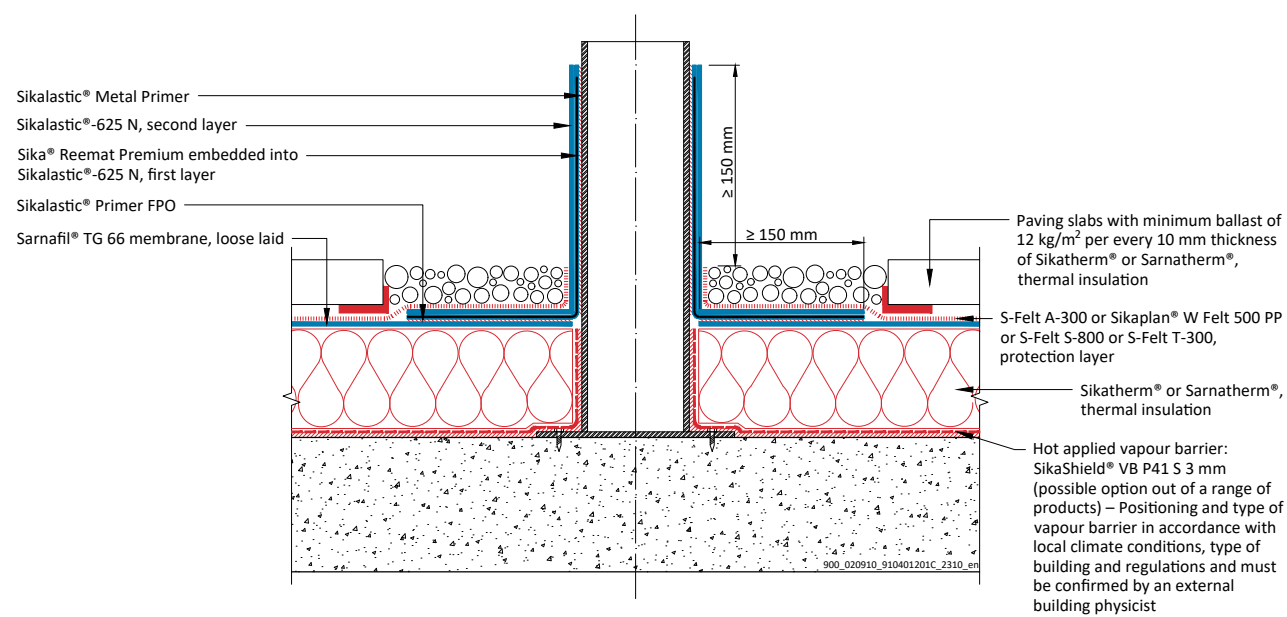

060.12.01 - Adhered Roof System

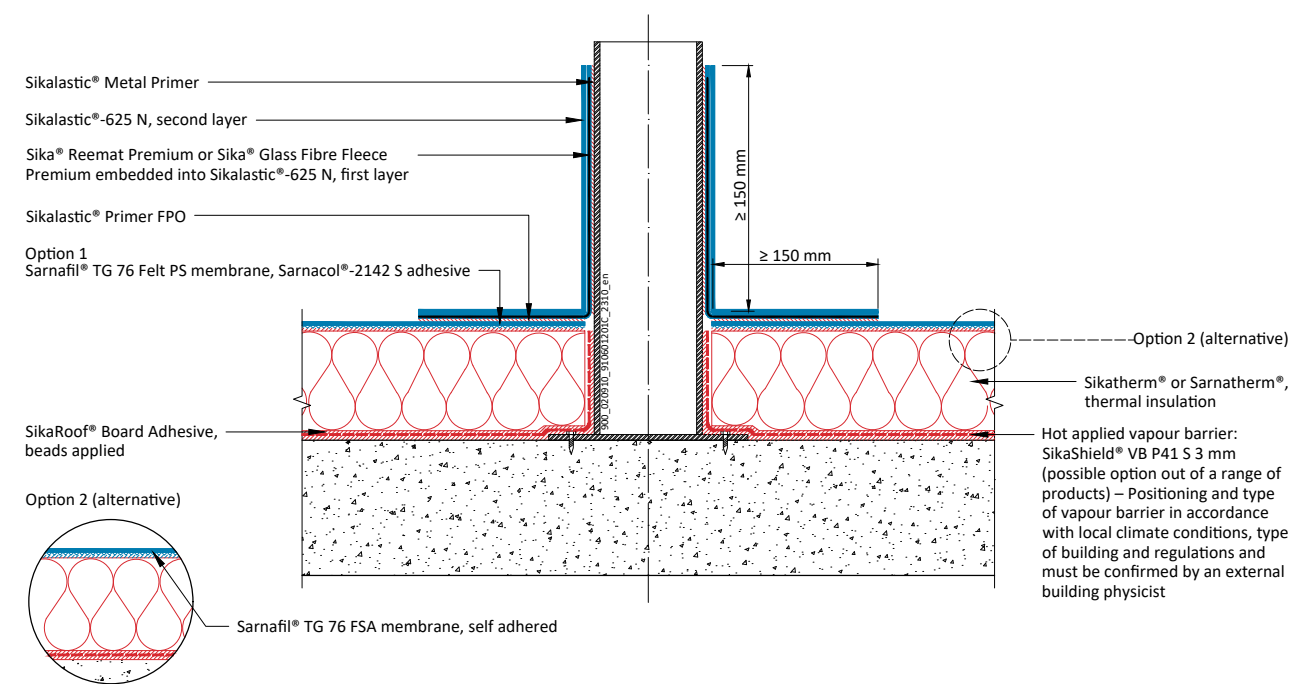



SUSTAINABLE SOLUTIONS

RESPONSIBLE FOR THE FUTURE - SIKA ROOFING SOLUTIONS	238
MORE VALUE LESS IMPACT	239
THE SIKA LIFE CYCLE APPROACH	240
THE SIKA LIFE CYCLE APPROACH FOR ROOFING SYSTEMS	241
SIKA INITIATIVES	242
SUSTAINABILITY PERFORMANCE CONFIRMED BY EPD AND LCA	246
CONTRIBUTING TO GREEN BUILDING CERTIFICATION PROGRAMS	247

RESPONSIBLE FOR THE FUTURE – SIKA ROOFING SOLUTIONS



Climate change and a growing population require cleaner energy and better-functioning cities. These forces are driving the demand for intelligent construction materials and smart mobility systems to ease congestion and reduce CO₂ emissions.

Sustainability is an important component of Sika's growth strategy and a clear focus in product development. The ambition of Sika product engineers: to extend the service life of buildings and industrial applications in order to reduce maintenance effort, to improve energy and material efficiency, and to further enhance user-friendliness and health and safety profiles.

Sika strives to create more value for all its stakeholders with its products, systems and solutions along the entire value chain and throughout the life span of its products. Performance is the foundation of sustainability.

Sika roofing solutions take less from the environment and offer more in durability and longevity, which results in a smaller overall environmental footprint.



MORE VALUE LESS IMPACT



HOW CAN SIKA ROOFING SYSTEMS CONTRIBUTE TO SUSTAINABLE CONSTRUCTION?

Long-lasting, high-performance roofing systems can make a major contribution to sustainable construction. Raw materials, production, application, the use phase and maintenance have significant influence on the overall sustainability performance of roofing applications. The contribution of roofing systems to sustainable construction is evaluated from a life-cycle perspective and evidenced through the various reference projects presented in this brochure.

RAW MATERIALS AND PRODUCTION

Energy and resource efficiency: Sika provides roofing systems that use less energy and resources in comparison with competitive technologies.

Climate protection: Sika provides roofing systems with low global warming potential. This means a reduced carbon footprint.

APPLICATION

Air quality: Sika provides low-VOC and VOC-free roofing solutions that help reduce summer smog and improve health and safety conditions during the roof installation process. The low-odor performance of Sika products has been externally tested and certified.

DURABILITY

The durability of building materials is a key to sustainable building construction. Internal and external studies document the outstanding service life of Sarnafil® roofing systems. A flat roof, using the proper materials and installed by professionals, is tight for the lifetime. However, if unpredictable mechanical influence occurs, for example subsequent application of ballast such as green roof, it can lead to unintended leaks in the waterproofing layer. As a solution SikaRoof® Control System provides security for investors and building owners.

USE AND MAINTENANCE

Saving energy: Sika solar reflective membranes help save energy by increasing the reflectivity and as a consequence reducing the cooling energy demand of buildings.

Saving energy: Sika roofing systems can save energy by incorporating high-performance thermal insulation.

Generating energy: Sika SolaRoof® systems allow the production of energy, while Sika solar reflective membranes improve photovoltaic panel efficiency.

Improving the microclimate: Sika green roofing systems help improve the microclimate and mitigate the development of urban heat islands as well as help manage water runoff from roofs.

Extending service life: Sika roof refurbishment solutions allow extending the service life of existing roofs by using the existing buildup as a base for the new system.



Brochure:
Enabler of Sustainable Construction

THE SIKA LIFE CYCLE APPROACH

What is Life Cycle Assessment (LCA) and why is it relevant?

Life Cycle Assessment (LCA) is a standardized method to assess and compare the inputs, outputs and potential environmental impacts of products and services over their life cycle. LCAs are increasingly recognized as the best way to evaluate the sustainability performance of construction products and systems.

What impact categories and resources indicators are included in an LCA?

There are several impact categories and resource indicators which can be assessed according to Standard EN 15804 "Sustainability of construction works – Environmental product declarations – Core rules for the product category of construction products." For roofing the most relevant impact categories and resource indicators are the following:

Global Warming Potential

Global warming potential (GWP) [kg CO₂-eq.] ("carbon footprint") is the potential contribution to climate change due to greenhouse gas emissions.

Cumulative Energy Demand

Cumulative energy demand (CED) [MJ] ("energy footprint") is the total amount of primary energy from renewable and non-renewable resources.

Photochemical Ozone Creation Potential

Photochemical ozone creation potential (POCP) [kg C₂H₄-eq.] ("summer smog") is the formation of reactive chemical compounds, e.g., ozone, from direct sunlight on certain primary air pollutants, which may be harmful to human health, ecosystems and crops.

On what standards are Sika LCAs based?

Sika carries out LCAs according to the ISO 14040 series and the Standard EN 15804. The impact assessment methodology used is CML 2001.

Where does the Sika LCA data come from?

The data for Sika LCAs is based on public databases, such as those from ecoinvent, the European Reference Life Cycle Database (ELCD) and thinkstep-GaBi, plus specific data from Sika plants and products.

Which life cycle phases are included in the sika LCAs?

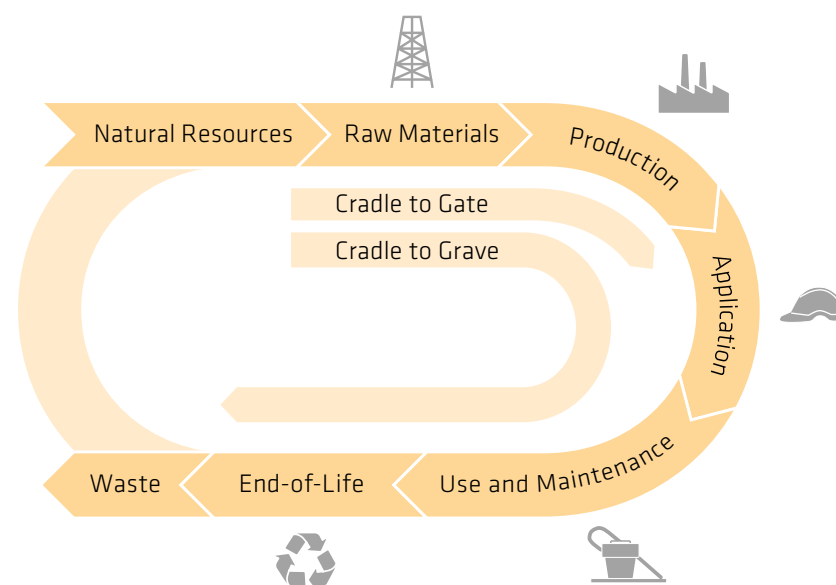

"Cradle to gate"

In the "cradle to gate" approach, the LCA investigates the potential environmental impact of a product from raw material extraction to finished production.

"Cradle to grave"

In the "cradle to grave" approach, the LCA investigates the potential environmental impact of a product from raw material extraction, production, application and use to final disposal at the end of life.

THE SIKA LIFE CYCLE APPROACH FOR ROOFING SYSTEMS



What is included in Sika roofing LCAs?

The LCA results given in this brochure refer to 1 m² of the roofing system and are based on either the cradle to gate or the cradle to grave approach¹⁾.

Which life cycle phases are most relevant for roofing?

From a **cradle to gate** perspective, the majority of the potential impacts are related to the raw materials **(A)** used to produce **(B)** the roof waterproofing layer and the other roofing system components.

From a **cradle to grave** perspective, the use phase **(D)** and the end-of-life phase **(E)** have the most significant influence on the overall sustainability performance of roofing applications, due to their contributions to save and / or create energy, to avoid carbon emissions and to save resources at the end of life. The leverage of all of these potential benefits is long-lasting functionality and durability.

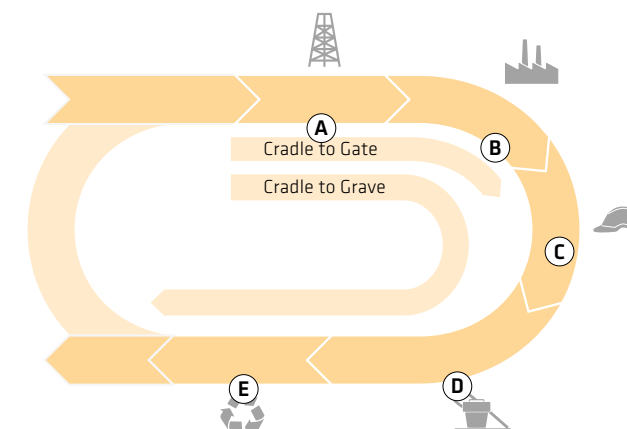

1) In the LCAs, neither the roof construction (steel deck, concrete deck, soil, plants, etc.) nor capital goods (e.g. machinery) are considered.

Who prepares and reviews Sika roofing LCAs?

Sika roofing LCAs are created internally by the Sika Corporate Product Sustainability Group, using state-of-the-art GaBi software from thinkstep. The LCA model used has been reviewed by the leading independent research institute Swiss Federal Laboratories for Materials Science and Technology (EMPA).

What are the Sika sustainable roofing solutions?

Sika evaluates its roofing products and systems systematically with regard to environmental impact and contributions to sustainable construction based on regular and fully comprehensive Life Cycle Assessments.

What are the Sika sustainable solutions?

Air quality and emissions
Roofing products that promote good air quality and minimize emissions.

Energy
Roofing products that promote energy efficiency principles.

Climate
Roofing products that minimize the impact on the climate.

Resources
Efficient use of precious resources.

SIKA INITIATIVES

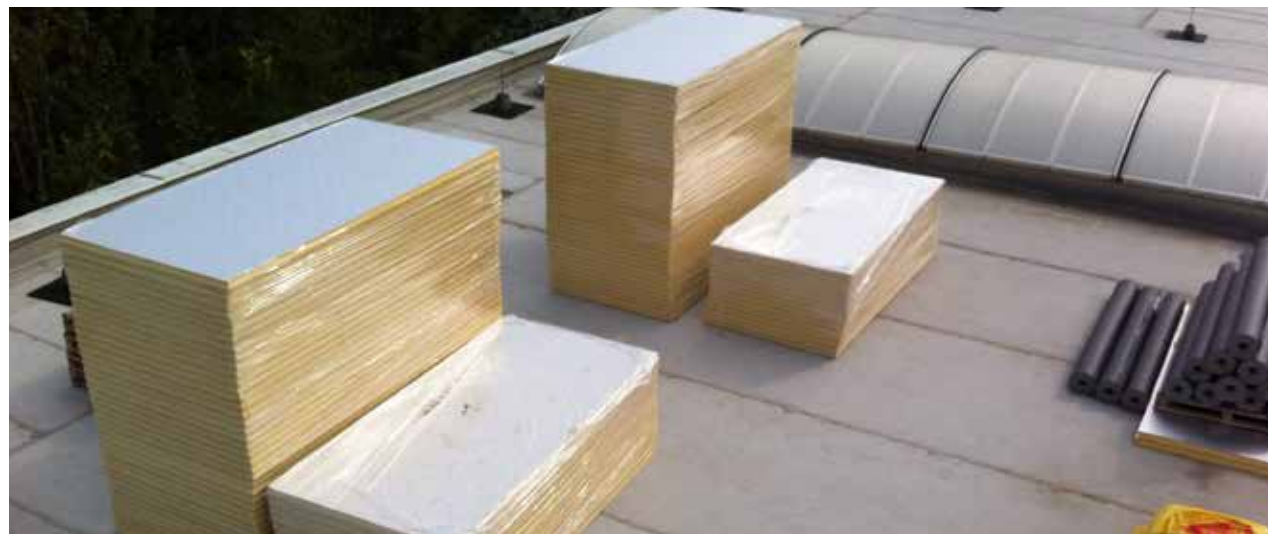

SIKA HIGH-PERFORMANCE THERMAL INSULATION

Thermal insulation is a key to creating a comfortable environment inside a building and it is also a key to saving energy. The importance of insulation has increased along with continuously evolving insulation standards worldwide, which place higher and higher demands on the thermal resistance of buildings in order to reduce energy demand for heating and cooling. Sika provides a wide range of thermal insulation materials specially designed and manufactured for optimal performance as part of Sika roofing systems. For example, Sikatherm® PIR thermal insulation board is known for low thermal conductivity, low density and good compressive strength. Most boards are coated with an aluminium, glass tissue or paper facer, which prevents outgassing effects.



SIKA TAKES SOLAR REFLECTIVITY TO A NEW LEVEL

The benefits of solar-reflective materials and colors are well known and understood, especially in warm climates around the world. With urban density increasing, the heat-island effect impacts cities at an ever increasing rate. White highly reflective thermoplastic increase reflectance and reduce both the heat-island effect and the cooling energy consumption of buildings. Sika roofing systems support LEED Green Building certification by providing a very high initial Solar Reflectance Index (SRI) and high 3-year SRI values according to CRRC (Cool Roof Rating Council) and ECRC (European Cool Roof Council) standard procedures.



Sika SolaRoof® SYSTEMS FOR SOLAR ROOFTOP APPLICATIONS

The great opportunity, of using flat rooftops for solar applications was recognized early by Sika. The first photovoltaic (PV) installations on Sarnafil® membranes date back to 2004. Several development steps led to the current Sika® SolarMount-1 (SSM1) system. SSM1 requires no roof penetrations but is hot-air welded to the Sika membrane, which prevents lateral movement of the PV plant on the roof over time. The PV panels on SSM1 can be oriented south or east-west with same SSM1 components.

Sika maintains its own solar parks in several locations to:

- Monitor the energy yield of different PV technologies
- Collect first-hand experience with long-term performance
- Showcase the flexibility of Sika roofing solutions for PV applications



A NATURAL HABITAT ON YOUR ROOF

The addition of a green roof to an otherwise unused area of a building is beneficial for the surrounding environment and can also contribute to your green building certification rating. Green roofs are great insulators and can significantly lower a building's cooling energy consumption and costs. Furthermore, green roofs filter air by absorbing and converting carbon dioxide to oxygen. Sika green roofing systems help improve the microclimate, mitigate the development of urban heat islands and help manage water runoff from roofs.

SIKA INITIATIVES

**SIKA'S ROOFING SYSTEMS ARE DESIGNED TO LAST**

Proven performance over time is perhaps the signature attribute of Sika roofing systems, which are also known for effective watertightness, energy efficiency and minimal environmental impact. This longevity under real-world conditions is proven around the world, for all construction types and in all types of climates.

The roof of the First United Methodist Church in Gilford, NH (USA) has two unique features. The first is obvious – it has a very distinctive, sweeping shape known as the hyperbolic paraboloid. The second characteristic is not so apparent – installed in 1976, this roof was one of the very first Sika single-ply membrane installations in North America. It replaced a failing roof buildup that was only a few years old. The roof is still in place today, periodically maintained and in good condition.

**MINIMIZING SITE WASTE IN ROOF REFURBISHMENT**

Upgrading the thermal performance of existing buildings is an ideal way to save energy and comply with UK building regulations. A thermal upgrade can be easily achieved by installing additional insulation over the existing substrate and covering it with a Sika roofing system. By using the existing buildup as a base for the new system, the client benefits from:

- Reduced carbon costs of the roofing system
- Reduced waste because the existing system remains in situ and need not be removed (stripped out)
- Minimal disruption to the operation of the building during installation
- A cost-effective method of increasing the design life of the building's roofing system

**THE SIKA RESPONSIBILITY FOR HEALTH & ENVIRONMENT****Sika is a responsible company that takes health & safety seriously**

The application method is very important for roof areas requiring torch-free membranes such as timber roof decks or timber upstands, timber fillets, hanging tiles, thatched roofs, roof light kerbs and upstands, cladding, lantern roof lights, confined spaces and window sills. Particular attention should be given to concealed flammable materials where there is the potential for flames to travel and ignite particles in inaccessible areas. For all these cases, Sika Roofing systems specially engineered for “no flame” applications are available and completely free of such risks.

Health & safety during application

Sika roofing systems are all designed for outdoor application and comply with the latest health & safety regulations¹⁾. Independent studies confirm that the exposure to solvents during application remains well below allowed workplace exposure levels. The use of Sika solutions containing VOCs (volatile organic compounds) is therefore safe when carried out in accordance with the materials application guidelines and the product data sheets²⁾.

Low-VOC and VOC-free roofing solutions

Sika provides intelligent solutions, using the most advanced technologies. Sika has developed low-VOC and VOC-free roofing systems (e.g. Sarnacol[®] for adhered roofing systems) for markets and customers who want to avoid products containing such solvents.

1) Exceptions may apply. Please contact your local Sika organization.

2) Local health and safety regulations must be followed. For further information please contact your local Sika organization.

SUSTAINABILITY PERFORMANCE CONFIRMED BY EPD AND LCA



Interest in Environmental Product Declarations (EPDs) has grown dramatically since recent versions of the U.S. Green Building Council's (USGBC) Leadership in Energy and Environmental Design (LEED) program and the UK's British Research Establishment Environmental Assessment Method (BREEAM) award credits for buildings incorporating products with EPD, which provide added value and comprehensive information for assessing buildings and other structures. Sika provides custom Life Cycle Assessment (LCA) calculations, Environmental Product Declarations (EPD) and project specific reports developed with internal tools. The EPDs are a standardized way to communicate relevant environmental information of products by quantifying the environmental aspects and potential environmental impacts throughout the product's life cycle based on quantitative data from LCA.



In Europe and in the USA, Sika has published product-specific EPDs for all its major roofing membrane brands and technologies. The EPDs conform to the EN 15804 and ISO 14025 standards and are externally verified by the IBU (DE), BRE (UK) and ASTM International (USA). For further information on EPDs please contact your local Sika organization.



CONTRIBUTING TO GREEN BUILDING CERTIFICATION PROGRAMS

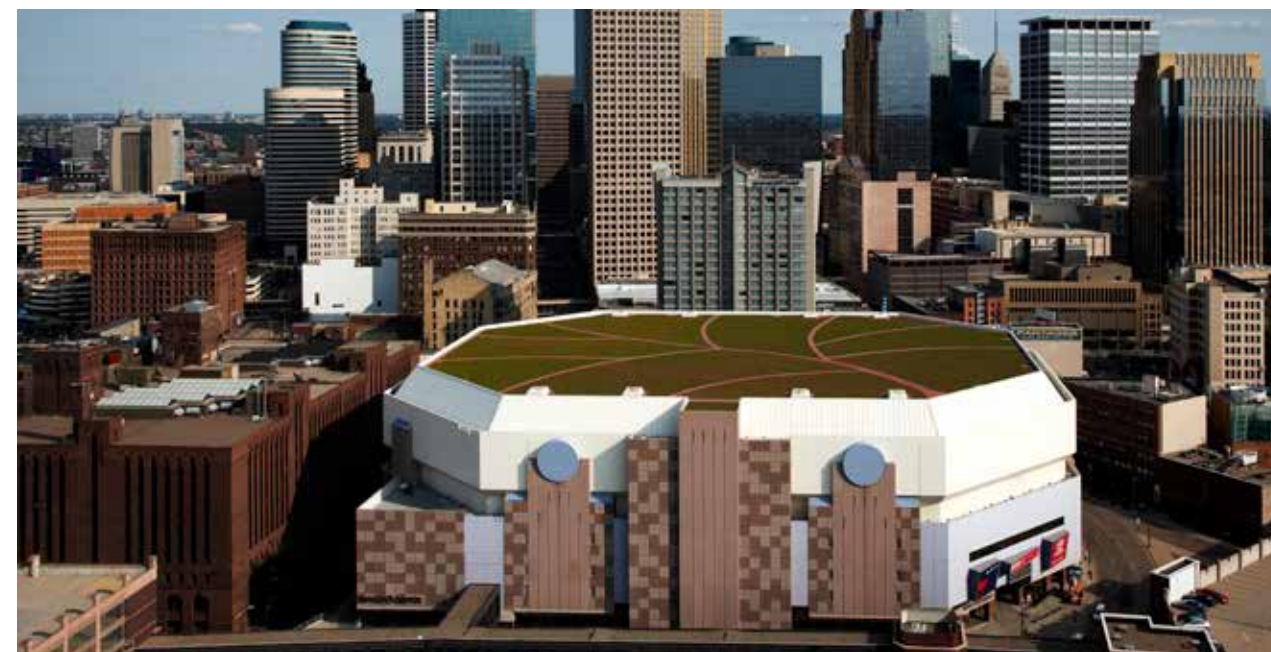

Over the recent years, several countries and organizations have developed environmental certification programs for buildings. The criteria of the programs are similar, whereas the evaluation may differ substantially. Green building certification programs focus on assessing whole buildings or building products. Sika is actively involved in all major green building programs around the world. Most relevant from the global perspective are LEED, BREEAM and DGNB.

LEED (Leadership in Energy and Environmental Design)

LEED is the world's best known and largest "green building" certification system. It was developed in 2000 by the U.S. Green Building Council (USGBC) and is most relevant for North America but is also heavily used in many other regions around the world, such as South America, Europe and Asia. It is based on a set of rating categories in which specific topics are assessed. The products environmental impact is determined by using LCAs and EPDs.

BREEAM (BRE Environmental Assessment Method)

BREEAM is an environmental assessment method and rating system for buildings launched in 1990 by the BRE (UK). Local adaptations are also used in other countries such as the Netherlands, Sweden and Spain. BREEAM assesses the overall performance of buildings using factors such as energy and water use, the internal environment (health and wellbeing), pollution, transport, materials etc., awarding credits in each area according to defined performance criteria. The products environmental impact is determined using LCAs and EPDs.

DGNB (Deutsches Gütesiegel für Nachhaltiges Bauen)

The DGNB certification system was developed by the German Sustainable Building Council and the German government in 2009. The system is used in Germany and internationally. DGNB is based on up to 50 criteria in six quality sections, including Environmental Quality, Economic Quality and Technical Quality. For the Environmental Quality section, LCA data and EPDs are used.

MORE VALUE - GREEN BUILDING CONTRIBUTION

Relevant Sika contributions are as follows:

LEED®	BREEAM®	DGNB
LEED® v4 SSc 5: Heat island reduction – traffic white (RAL 9016) MRc 2: Building disclosure – EPD MRc 3: Building disclosure – sourcing of raw materials MRc 4: Building disclosure – material ingredients MRc 5: Construction and demolition waste management	BREEAM® UK-NC 2018 Mat01: Life cycle impacts Mat03: Responsible sourcing of materials Mat04: Insulation Wst01: Construction waste management	DGNB 2018 ENV1.1: Building Life Cycle Assessment ENV1.2: Local environmental impact SOC1.6: Indoor and Outdoor quality TEC1.6: Ease of recovery and recycling

Disclaimer

The information, and, in particular, the recommendations relating to the application and end-use of Sika products, are given in good faith based on Sika's current knowledge and experience of the products when properly stored, handled and applied under normal conditions in accordance with Sika's recommendations. In practice, the differences in materials, substrates and actual site conditions are such that no warranty in respect of merchantability or of fitness for a particular purpose, nor any liability arising out of any legal relationship whatsoever, can be inferred either from this information, or from any written recommendations, or from any other advice offered. The user of the product must test the product's suitability for the intended application and purpose. Sika reserves the right to change the properties of its products. The proprietary rights of third parties must be observed. All orders are accepted subject to our current terms of sale and delivery. Users must always refer to the most recent issue of the local Product Data Sheet for the product concerned, copies of which will be supplied on request.

FURTHER ROOFING PUBLICATIONS ALSO AVAILABLE FROM SIKA

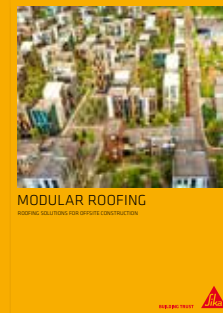
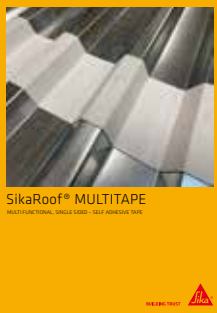
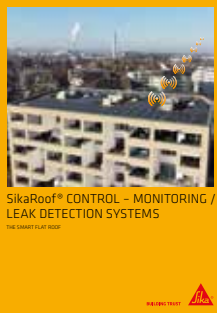
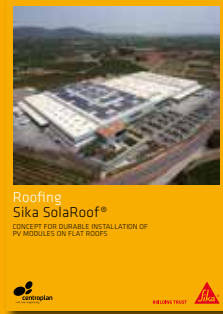
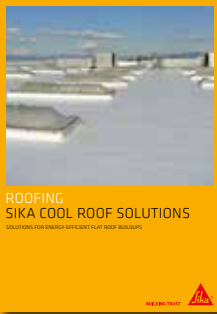
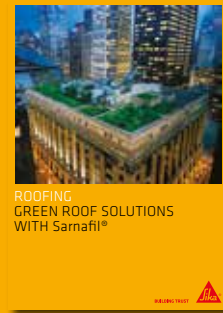
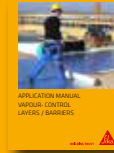
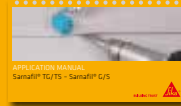
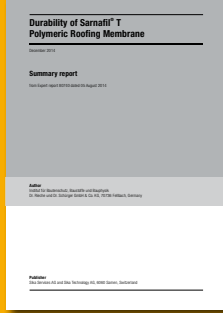
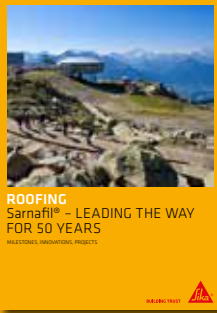

WE ARE SIKA

Sika is a specialty chemicals company with a leading position in the development and production of systems and products for bonding, sealing, damping, reinforcing and protecting in the building sector and the motor vehicle industry. Sika's product lines feature concrete admixtures, mortars, sealants and adhesives, structural strengthening systems, flooring as well as roofing and waterproofing systems.

Our most current General Sales Conditions shall apply. Please consult the most current local Product Data Sheet prior to any use.



SIKA SERVICES AG
Tueffenwies 16
CH-8048 Zurich
Switzerland

Contact
Phone +41 58 436 40 40
www.sika.com

BUILDING TRUST

